

# Güralp Minimus, Minimus+, Fortimus, Certimus

## *Technical Manual*

*Document Number: MAN-DIG-0001*

*Issue A 05/03/2025 16:38:17*

---

*Designed and manufactured by*  
Güralp Systems Limited  
3 Midas House, Calleva Park  
Aldermaston RG7 8EA  
England

---

# Table of Contents

---

<b>1</b>	<b>Part 1: Instrument-Specific Information .....</b>	<b>13</b>
1.1	Minimus and Minimus+ .....	13
1.1.1	System Overview.....	13
1.1.2	System Description.....	14
1.1.3	System Setup .....	20
1.1.4	Instrument and Channel Names .....	21
1.1.5	Technical Drawings.....	27
1.2	Fortimus.....	29
1.2.1	System Overview.....	29
1.2.2	System Description.....	30
1.2.3	System Setup .....	36
1.2.4	Installation .....	37
1.2.5	Instrument and Channel Names .....	40
1.3	Certimus .....	43
1.3.1	System Overview.....	43
1.3.2	System Description.....	44
1.3.3	System Setup .....	51
1.3.4	Installation .....	52
1.3.5	Instrument and Channel Names .....	55
<b>2</b>	<b>Part 2: Common Information .....</b>	<b>59</b>
2.1	Unpacking.....	59
2.1.1	The Purchased Item .....	59
2.1.2	Ethernet Cable.....	59
2.1.3	Compact GNSS Receiver and Cable .....	61
2.1.4	Power Cable .....	62
2.1.5	Diagnostic GNSS to Serial Cable Adapter.....	63
2.2	Getting Started: System Setup and Network Configuration .....	65
2.2.1	I.P. Address Configuration on PC or Laptop.....	66
2.2.2	Your Device’s IP address: Discovery.....	68

---

## Minimus, Minimus+, Fortimus, Certimus

2.2.3	Web Page Interface Login.....	69
2.2.4	I.P. Address Configuration.....	70
2.2.5	System Status .....	72
2.2.6	Configurable Station Metadata.....	74
2.3	Data Storage.....	75
2.3.1	Data Record Tab.....	75
2.3.2	Recording Status .....	76
2.3.3	MicroSD Card Re-Formatting.....	77
2.3.4	MicroSD Card Data Flushing and Unmounting .....	78
2.3.5	Bulk Data Download via Webpage.....	79
2.3.6	Time-Based Data Download via Webpage.....	80
2.3.7	Bulk Data Extraction via Network.....	80
2.3.8	Time Based Data Extraction via Network .....	81
2.3.9	Bulk Data Extraction from MicroSD card .....	83
2.3.10	MiniSEED Extractor .....	86
2.4	Data Transmission .....	88
2.4.1	Data Stream Tab.....	88
2.4.2	GDI-Link Protocol .....	89
2.4.3	SEEDlink Protocol .....	91
2.4.4	QSCD.....	95
2.4.5	Scream! (GCF Format + Scream Protocol) .....	95
2.5	Synchronisation of the Sample-Clock.....	96
2.5.1	GNSS .....	96
2.5.2	PTP (Precision Time Protocol) .....	97
2.5.3	NTP (Network Time Protocol) .....	99
2.6	Deploy Modes.....	101
2.6.1	Full Power-Save Mode.....	102
2.6.2	GPS Power-Save Mode.....	102
2.6.3	LAN Power-Save Mode .....	102
2.6.4	GPS & LAN Power-Save Mode.....	103
2.6.5	Maris Deployment.....	103
2.7	Configuration and Control of Connected Instruments .....	104
2.7.1	Analogue Instruments.....	104
2.7.2	Digital Instruments .....	110
2.7.3	Sensor Orientation and Installation Parameters .....	110
2.7.4	Injecting a Calibration Signal.....	111
2.8	Transforms.....	113

## Minimus, Minimus+, Fortimus, Certimus

2.8.1	Pass-Through .....	114
2.8.2	Differentiation.....	114
2.8.3	1 <sup>st</sup> Order LPF .....	115
2.8.4	1 <sup>st</sup> Order HPF .....	115
2.8.5	1 <sup>st</sup> Order Band/Notch Filter .....	116
2.8.6	2 <sup>nd</sup> Order Biquad.....	117
2.8.7	Integration.....	118
2.8.8	Double Integration .....	119
2.8.9	EEW CAP Parameters – Observer .....	120
2.8.10	STA/LTA Ratio.....	122
2.8.11	Rotation (Triplet).....	123
2.8.12	QSCD Sender (Triplet).....	125
2.8.13	MMA Logger .....	125
2.9	Triggers.....	127
2.9.1	Trigger Sources .....	127
2.9.2	Trigger Destinations.....	134
2.9.3	CAP Receiver .....	136
2.9.4	How to Configure a Trigger Step-By-Step .....	137
2.9.5	Seismic Event Table.....	141
2.9.6	Improving Latency .....	142
2.10	Instrument’s Metadata .....	144
2.10.1	Dataless SEED Volume .....	144
2.10.2	RESP File .....	144
2.10.3	Station XML File .....	146
2.11	Instrument’s State of Health (SOH) .....	148
2.11.1	LED Indicator.....	148
2.11.2	Commands on the Debug RS232 Serial Port.....	149
2.11.3	HTTP State Of Health and Configuration Resources .....	149
2.12	WiFi Connectivity .....	152
2.13	Updating DIG Firmware .....	153
2.14	Import / Export an Existing Configuration .....	156
2.15	Scripting.....	158
2.15.1	Enabling Scripting Capability .....	158
2.15.2	Preparing the Script File .....	158
2.15.3	Sending a Script File.....	161
2.15.4	Status of the Script Running Process.....	162
2.16	LCD Display Menu.....	163



## Minimus, Minimus+, Fortimus, Certimus

2.16.1	Status .....	164
2.16.2	Settings .....	165
2.16.3	Alignment.....	168
2.16.4	Waveform .....	168
2.16.5	Maintenance .....	169
2.16.6	Controlling the LCD from the Web Interface.....	170
2.16.7	LCD Menu Map.....	173
2.17	Bluetooth Connectivity: the GüVü App.....	174
2.17.1	Getting Stated.....	174
2.17.2	Selecting Data Sources .....	176
2.17.3	View Settings.....	176
2.17.4	Instrument Control .....	177
2.17.5	Emailing a Deployment Report .....	178
2.18	Advanced Troubleshooting .....	181
2.18.1	Reset All Settings During Boot Phase .....	183

# Preliminary Notes

## Proprietary Notice

The information in this document is proprietary to Güralp Systems Limited and may be copied or distributed for educational and academic purposes but may not be used commercially without permission.

Whilst every effort is made to ensure the accuracy, completeness and usefulness of the information in the document, neither Güralp Systems Limited nor any employee assumes responsibility or is liable for any incidental or consequential damages resulting from the use of this document.

## Cautions and Notes

Cautions and notes are displayed and defined as follows:



**Caution:** A yellow triangle indicates a chance of damage to or failure of the equipment if the caution is not heeded.



**Note:** A blue circle indicates a procedural or advisory note.

## Manuals and Software

All manuals and software referred to in this document are available from the Güralp Systems website: [www.guralp.com](http://www.guralp.com) unless otherwise stated.

## Conventions

Throughout this manual, examples are given of command-line interactions. In these examples, a fixed-width typeface will be used:

`Example of the fixed-width typeface used.`

Commands that you are required to type will be shown in bold:

**Example of the fixed-width, bold typeface.**

Where data that you type may vary depending on your individual configuration, such as parameters to commands, these data are additionally shown in italics:

*Example of the fixed-width, bold, italic typeface.*

Putting these together into a single example:

## Minimus, Minimus+, Fortimus, Certimus

System prompt: **user input with *variable parameters***

# Understanding the Manual

## *Manual structure*

Thank-you for purchasing a Güralp Minimus, Minimus+, Certimus or Fortimus.

Güralp **Minimus** and **Minimus+** are a combined digitiser and advanced communications units. The Minimus provides four fully featured analogue input channels, whilst the Minimus+ increases this to a total of eight analogue inputs.



Güralp **Fortimus** is a digital, triaxial, strong-motion, force-feedback accelerometer.

Güralp **Certimus** is a digital, triaxial, broadband, force-feedback seismometer.

This manual is organised into two main sections.

- The first section is instrument-specific, and provides a general introduction to the instruments and their hardware. It shows how to set up your device and it advices on best practices to help with your deployment. The topics covered include:
  - System overview
  - System description
  - System set-up
  - Instrument and channel names
  - Installation
- The second section focuses on the instruments' firmware - called Dig. Dig is Güralp System's firmware for the Minimus and Minimus+ digitisers. Güralp's Fortimus and Certimus have an embedded Minimus digitiser and therefore run the same firmware. Within this second section of the manual, we provide instructions and describe features common to all the instruments running the Dig firmware, inclusive of the Minimus, Minimus+, Fortimus and Certimus.

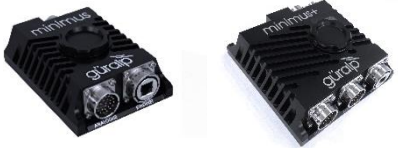
 **Note:** Minimus and Minimus+ units can be recognised by their serial numbers, which will be of the form MIN-XXXX or MINP-XXXX. Digitisers with serial numbers of the form MINL-XXXX are Minimus Lite units and run a different firmware, called Dig2. Although most features are common to both Dig and Dig2, this manual is dedicated to Minimus/Minimus+ and other devices with an embedded Minimus digitiser (Fortimus and Certimus).

	<p>Minimus Minimus+</p>	<p>Minimus and Minimus+ both run Dig firmware.  This is the correct document for these instruments.</p>
	<p>Certimus Fortimus</p>	<p>Fortimus and Certimus each contain a Minimus digitiser which runs Dig firmware.  This is the correct document for these instruments.</p>
	<p>Minimus Lite</p>	<p>Minimus Lite runs Dig2 firmware.  This is NOT the correct document for this instrument.</p>

 **Note:** For sake of brevity, instruments running the Dig firmware will be referred to as the *Minimus* throughout this document, but the instructions apply equally to the Minimus+, Fortimus and Certimus. Situations where instructions only refer to a specific instrument, or where they do not apply to one or more of them, this will be indicated.

## Güralp Discovery Software

Güralp Discovery is our software application for configuration, control, state-of-health monitoring, waveform viewing and acquisition of instruments running the Dig firmware.

Discovery can be downloaded from the following link:

<https://www.guralp.com/sw/download-discovery.shtml>.

An important benefit of Discovery is that it allows users to identify their instruments' I.P. address on a LAN or via a cloud-based or organisational registry server, without the need for assigning a static I.P. address at the station.



**Note:** This document provides some information about Discovery, especially when related to the use of the Dig firmware, including firmware upgrades and configuration instructions.

However, full user instructions for Discovery are beyond the scope of this document. For full user information, please refer to Discovery's manual [MAN-DIS-0001](#) (also accessible from Discovery's dashboard as detailed below).

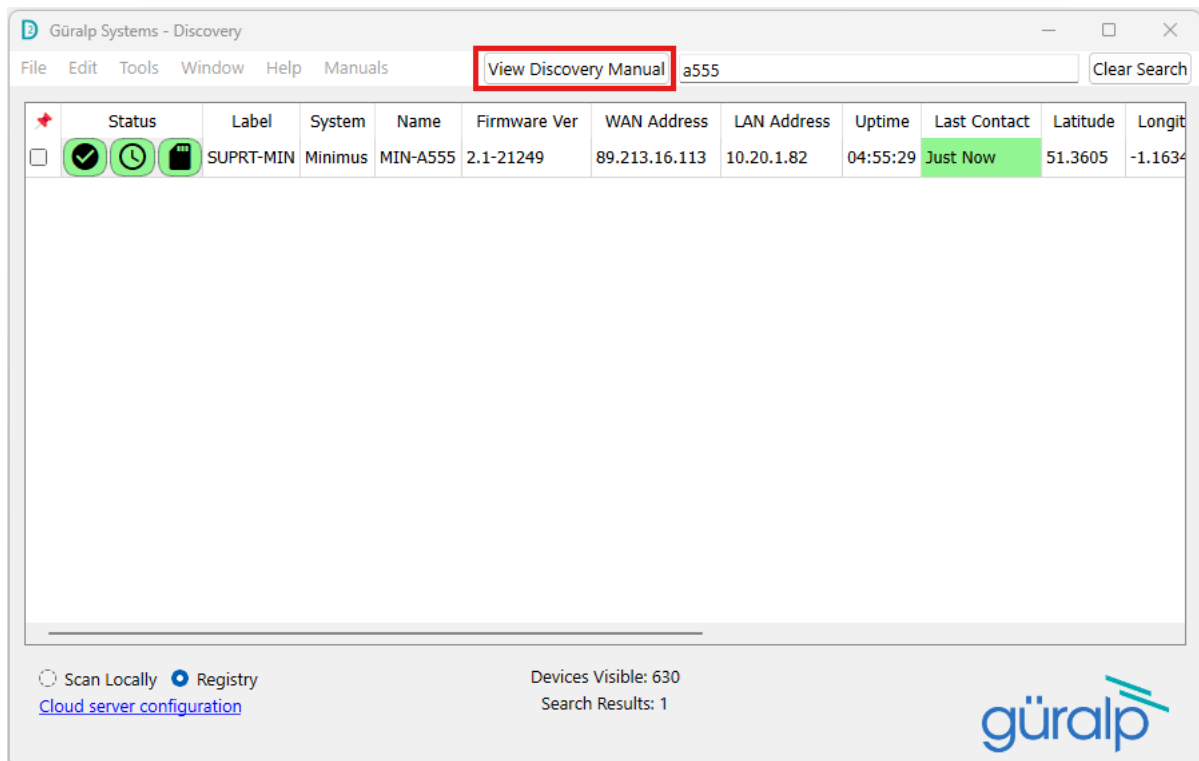

## Webpage Interface



**Note:** The Dig firmware is continuously improved to add new features, accommodate customers' requests, and refresh the webpage layout.

The design of your webpage may look slightly different from the examples shown in this document. The instructions are designed to be used with Dig versions 2.0 and upwards. If you encounter any problems, please email [support@guralp.com](mailto:support@guralp.com) for assistance.

If you read about features that you do not find available for your instrument, please read the Dig release notes:

[https://london.guralp.com/download/sw/release\\_MIN.shtml](https://london.guralp.com/download/sw/release_MIN.shtml) or consider upgrading your firmware with the instructions found in Chapter 0.

Monitoring and configuration controls are accessible through the webpage interface, with options including:

## Minimus, Minimus+, Fortimus, Certimus

- Sensor readings and instrument State of Health.
- Network configuration and authentication.
- Sensor, timing, and station configuration.
- Data streaming configuration.
- Local or networked data-storage configuration.
- Tools for secure access and download of data.

This document provides full user instructions about the webpage interface.

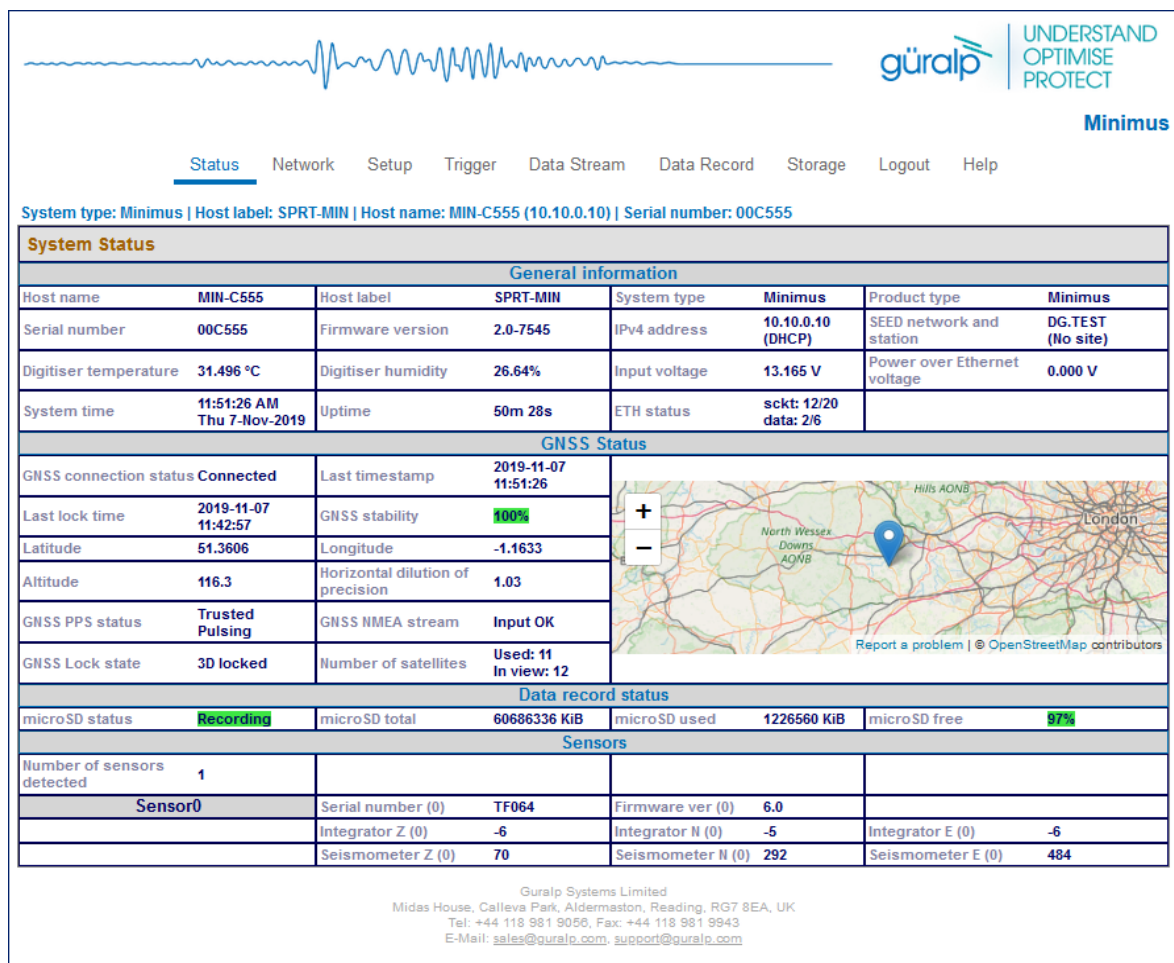

The screenshot displays the Minimus web interface. At the top right, the Guralp logo is accompanied by the tagline "UNDERSTAND OPTIMISE PROTECT". Below the logo, the word "Minimus" is displayed. A navigation menu includes "Status", "Network", "Setup", "Trigger", "Data Stream", "Data Record", "Storage", "Logout", and "Help". The "Status" tab is selected.

System information: System type: Minimus | Host label: SPRT-MIN | Host name: MIN-C555 (10.10.0.10) | Serial number: 00C555

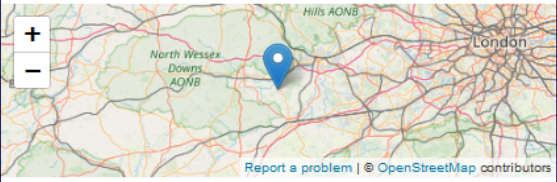
System Status					
General information					
Host name	MIN-C555	Host label	SPRT-MIN	System type	Minimus
Serial number	00C555	Firmware version	2.0-7545	IPv4 address	10.10.0.10 (DHCP)
Digitiser temperature	31.496 °C	Digitiser humidity	26.64%	Input voltage	13.165 V
System time	11:51:26 AM Thu 7-Nov-2019	Uptime	50m 28s	Power over Ethernet voltage	0.000 V
				ETH status	sckt: 12/20 data: 2/6
GNSS Status					
GNSS connection status	Connected	Last timestamp	2019-11-07 11:51:26		
Last lock time	2019-11-07 11:42:57	GNSS stability	100%		
Latitude	51.3606	Longitude	-1.1633		
Altitude	116.3	Horizontal dilution of precision	1.03		
GNSS PPS status	Trusted Pulsing	GNSS NMEA stream	Input OK		
GNSS Lock state	3D locked	Number of satellites	Used: 11 In view: 12		
Data record status					
microSD status	Recording	microSD total	60686336 KiB	microSD used	1226560 KiB
				microSD free	97%
Sensors					
Number of sensors detected	1				
	Sensor0	Serial number (0)	TF064	Firmware ver (0)	6.0
		Integrator Z (0)	-6	Integrator N (0)	-5
		Seismometer Z (0)	70	Seismometer N (0)	292
				Seismometer E (0)	484

Guralp Systems Limited  
Midas House, Calleva Park, Aldermaston, Reading, RG7 8EA, UK  
Tel: +44 118 981 9050, Fax: +44 118 981 9943  
E-Mail: sales@guralp.com, support@guralp.com

## Guralp Scream! Software

Data from the Minimus and attached sensors can also be viewed and analysed using Guralp's Scream! software. Scream! is a software application for seismometer configuration, real-time acquisition, and monitoring.



**Note:** Full user instructions for Scream! are beyond the scope of this document. Please refer to the Gralp manual: [MAN-SWA-0001](#) for full Scream user instructions.

## ***Gralp GV Bluetooth App***

The GV app provides monitoring and control of nearby instruments using the Bluetooth protocol. Full user instructions for the GV app can be found in Chapter 2.17 of this manual.



# 1 Part 1: Instrument-Specific Information



## 1.1 Minimus and Minimus+

### 1.1.1 System Overview





Thank you for purchasing a Güralp Minimus or Minimus+ digitiser.

This chapter describes the key components of a Minimus and Minimus+ system. The Minimus has four fully featured analogue input channels. The Minimus+ is physically wider, with an additional analogue sensor input connector, and provides eight fully featured analogue input channels.



**Note:** In this document, the symbol  is used to identify information that relates only to the Minimus+ and not to the Minimus. All other information relates to both units, unless obviously contradicted by a clause containing .

#### 1.1.1.1 Key Features

- 24-bit, four-channel ( eight-channel) digitiser with nominal 2.44  $\mu\text{V}/\text{count}$  sensitivity.
- Compact form, measuring just 134 × 99 × 45 mm ( 134 × 139 × 45 mm) and weighing just 0.67 kg ( 0.78 kg).
- Compatible with all analogue seismic sensors with a voltage output.
- Simultaneously accommodates one ( two) triaxial sensor(s), one ( two) infra-sound sensor(s) and a digital feed from a Radian post-hole or borehole instrument.
- Identification of I.P. addresses via Güralp Discovery software and a cloud-based or organisational registry server.
- Remote instrument and data management via Discovery.
- Bluetooth Android app for installation integrity checking.
- Low-latency mode for Earthquake Early Warning (<40 ms).
- Hot-swappable data storage with dual redundant microSD cards.
- GNSS time-synchronisation, compatible with Navstar (GPS), GLONASS, Galileo and BeiDou constellations. PTP is available for when GNSS is impractical.

#### 1.1.1.2 Typical Applications

- Earthquake Early Warning systems.

## Minimus, Minimus+, Fortimus, Certimus

- Volcanology.
- Multi-scale seismic networks.
- Structural health monitoring.
- Hydrocarbon exploration.
- Permanent reservoir monitoring.
- Induced seismicity detection.
- Explosion monitoring.

---

### 1.1.2 System Description

#### 1.1.2.1 Güralp Minimus Digitiser

The Güralp Minimus is a combined digitiser and advanced communications unit. The Minimus acquires data from – and allows direct control (where appropriate) of – connected analogue instruments (*e.g.* Güralp Fortis, 3-series, 5-series, 40T and 6T sensors) and digital instruments (*e.g.* the Güralp Radian and Certis). The following diagram details the ports and features of a Minimus:

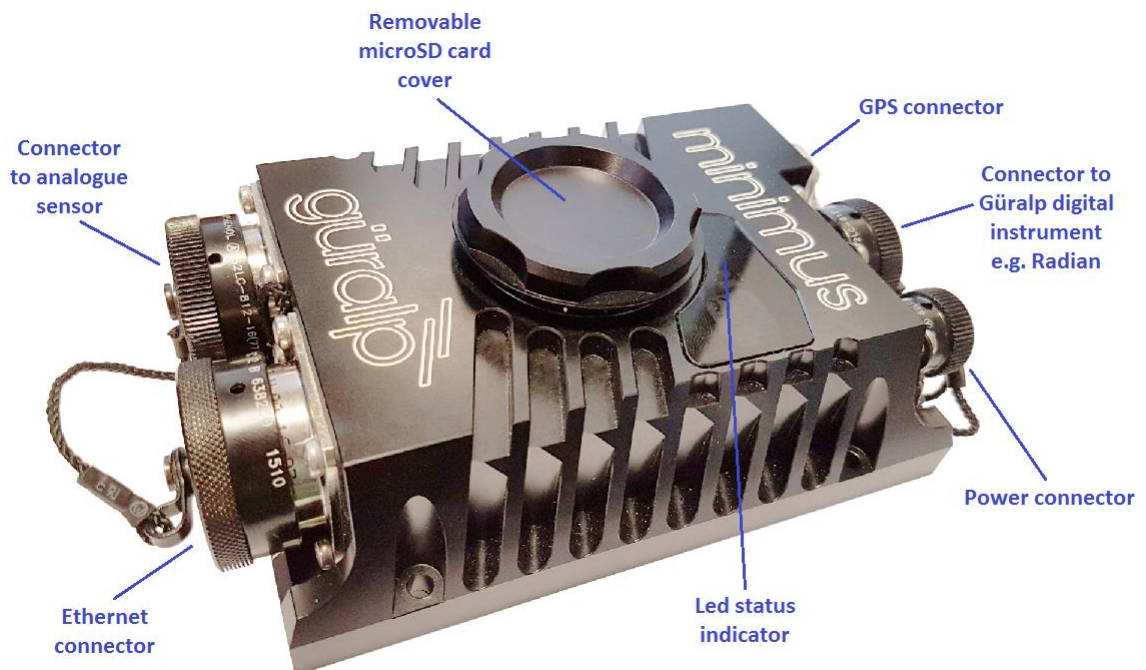

The Güralp Minimus functions as the Surface Interface Unit (SIU) for a Radian post-hole instruments in shallow depths of less than 100 metres.

⚠ The Minimus+ features an additional analogue sensor connector as shown below:



A full description of the operation, control and configuration of the Güralp Radian instrument via the Minimus is not within the scope of this manual; please refer instead to the Radian manual, [MAN-RAD-0001](#).



**Caution:** Analogue sensors with true floating outputs connected to the Minimus must have their outputs ground-referenced using a greater than 100k $\Omega$  resistor.

---

### 1.1.2.2 LED Indicator

The Minimus has an LED indicator on the upper surface, which provides status and configuration information. More details can be found in Chapter 2.11.1.

---

### 1.1.2.3 Bluetooth Connectivity

The Minimus features Bluetooth connectivity, allowing sensor and state-of-health data to be monitored using the Güralp GÜVÜ app (see Chapter 2.17 ) running on an Android mobile phone.

Bluetooth can be disabled via software to save processing power, but the hardware module cannot be switched off. BLE (Bluetooth Low Energy) technology is used to minimise the power requirement. The Bluetooth transmitter/receiver is in permanent standby mode and always ready to receive a connection from a phone or tablet.

---

### 1.1.2.4 Data Storage

The Minimus uses microSD (non-volatile) memory technology to store seismic data locally. The Minimus features two microSD cards to provide redundancy; this helps to protect your recorded data in the unlikely event of any corruption or problem with the memory cards. One card is internal and cannot be removed by the user; the other is hot-swappable and easily accessible from the top of the Minimus.

The Minimus is supplied with two microSD cards that are of equal storage capacity (*e.g.* two 16 GB cards).



**Note:** In order to ensure data integrity and security, Güralp only recommends the use of the supplied industrial-grade microSD cards.



**Caution:** When the external microSD card is removed, the internal card keeps recording data, unless recording is stopped using the **Unmount Cards** button (see Chapter 2.3.4). However, when the external card is re-connected, any data written to the internal card while the removable card was absent will be overwritten.

Starting from summer 2018, two designs of the card holder for the removable card became available. The following two sections describe how to change the card in the newer models and the original models.

---

### **Primary (Hot Swappable) microSD Card – New Style**

The upper surface of the Minimus has a waterproof screw-in card holder that is sealed by an O-ring.

To insert or replace a microSD card, proceed as follows:

1. Rotate the card holder in an anti-clockwise direction, unscrewing it from the body of the digitiser.

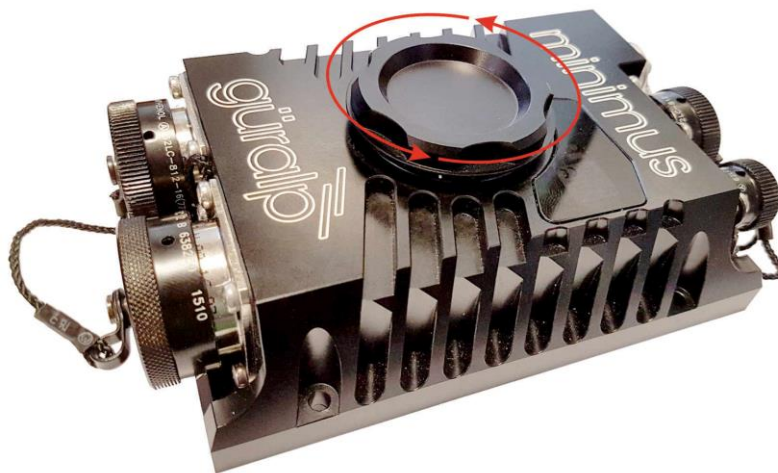



**Caution:** The card holder connects electrically to the Minimus via a series of slip-rings which ride on metal fingers in the main body of the digitiser:

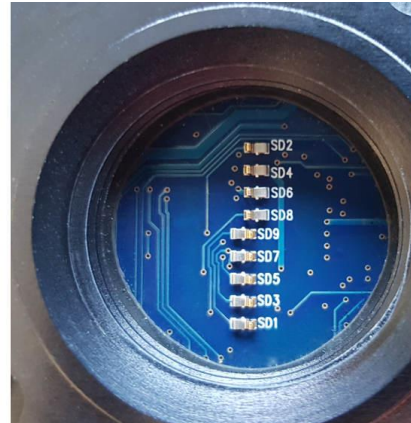
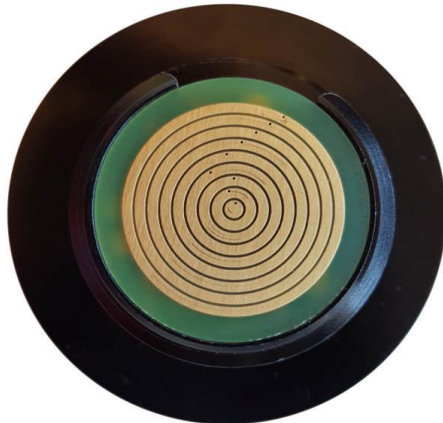

It is very important that the slip-rings and the metal finger-contacts do not become damaged or tarnished. Take care not to touch either part. If a Minimus has had its card holder removed, do not leave it exposed to the elements. If a card holder is to be transported when it is not installed in a Minimus, enclose it in a protective bag or covering so that it cannot be scratched or contaminated.

2. The microSD card is accessible via the slot in the side of the card holder. Using a pair of tweezers, first push the card in gently and then release the pressure: the card will spring outwards a little. It can now be grasped and withdrawn.
3. To insert a new card, line it up with the slot as shown and push it gently into place. Once you feel the spring pressure, continue pushing until more resistance is felt and then release the pressure: the card will lock into place.



4. Finally, replace the cap and rotate clockwise until hand-tight. Do not over-tighten and do not use tools.



## Primary (Hot Swappable) microSD Card – Old Style

Early models of the Minimus had a different arrangement. The upper surface of the Minimus had a waterproof screw cap that is sealed by an O-ring. This protects the microSD card slot from the environment.

To insert or replace a microSD card in an older Minimus, proceed as follows:

1. Rotate the cap in an anti-clockwise direction to reveal the microSD card slot. The microSD card is now exposed.

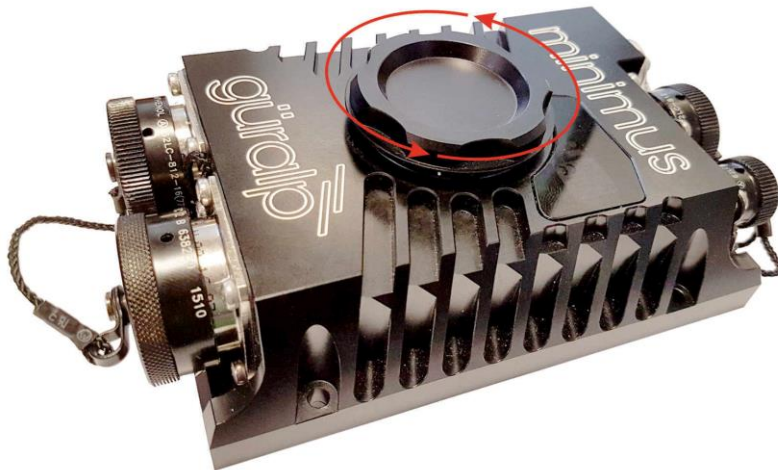

2. To make the microSD card slot accessible, use your finger to apply gentle pressure on the back of the card carrier until it slides into the open position.

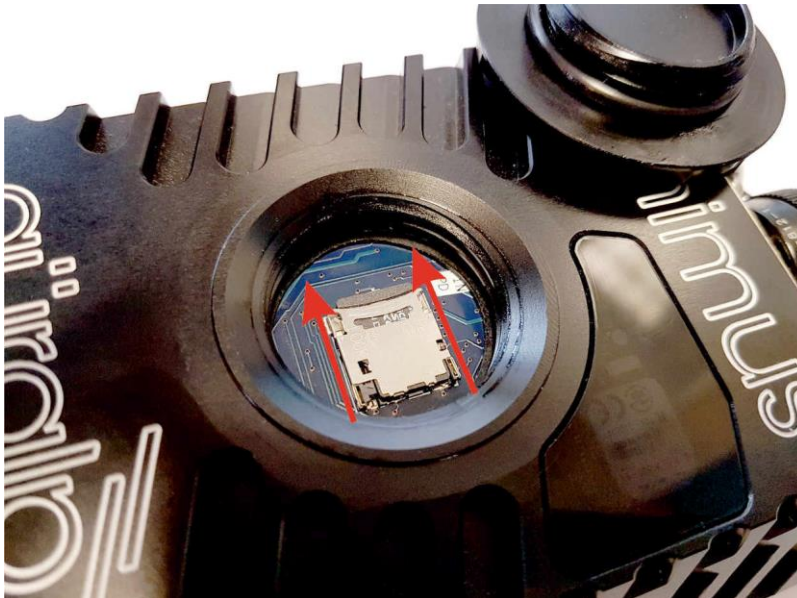

Minimus, Minimus+, Fortimus, Certimus

3. Gently lift the free end of the card carrier, which hinges at the other end, as shown.

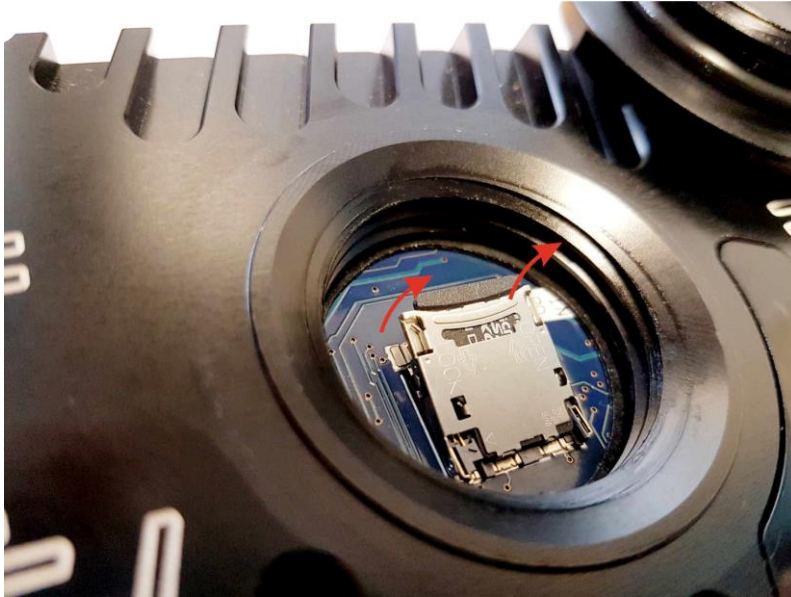

4. You should now be able to insert/remove a microSD card. The replacement should be positioned so that the gold contacts on the microSD card will be facing downwards when the carrier is hinged back down.

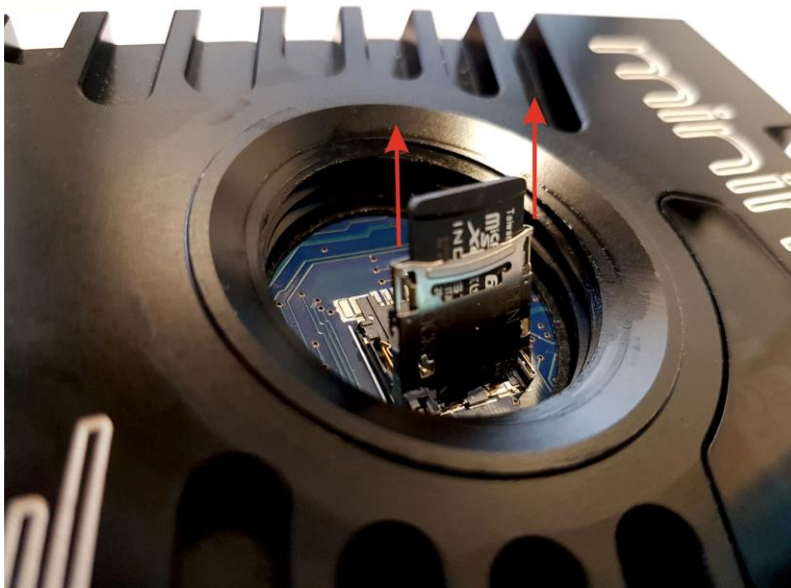

5. Push the hinged carrier firmly down and slide it back into the seat.

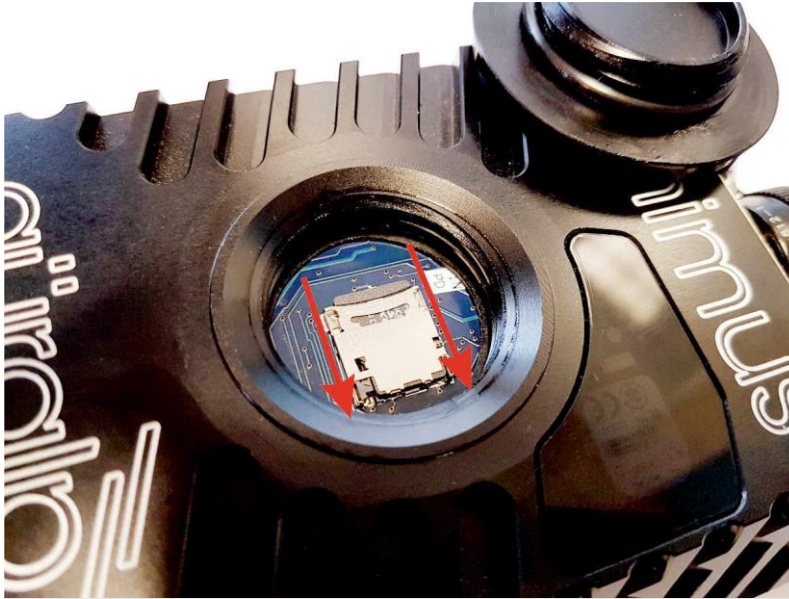

6. Finally, replace the cap and rotate clockwise until hand-tight. Do not over-tighten and do not use tools.



**Note:** In order to ensure data integrity and security, Güralp only recommends the use of the supplied industrial-grade microSD cards.



**Caution:** When the external microSD card is removed, the internal card keeps recording data. However, when the external card is re-connected, any data written to the internal card while the removable card was absent will be overwritten.

---

### Internal (Backup) microSD Card

The second microSD card is factory-installed in a slot inside the Minimus.



**Caution:** The internal microSD card is not accessible by the user. Attempts to remove or replace it will void the Minimus' warranty.

---

### 1.1.3 System Setup

Güralp highly recommends exploring and gaining familiarity with the Minimus inside your lab before installation in an outdoors environment.

A typical setup for the Minimus connected to an analogue sensor (including an optional digital Radian post-hole instrument) is shown in the figure below:



## Minimus, Minimus+, Fortimus, Certimus

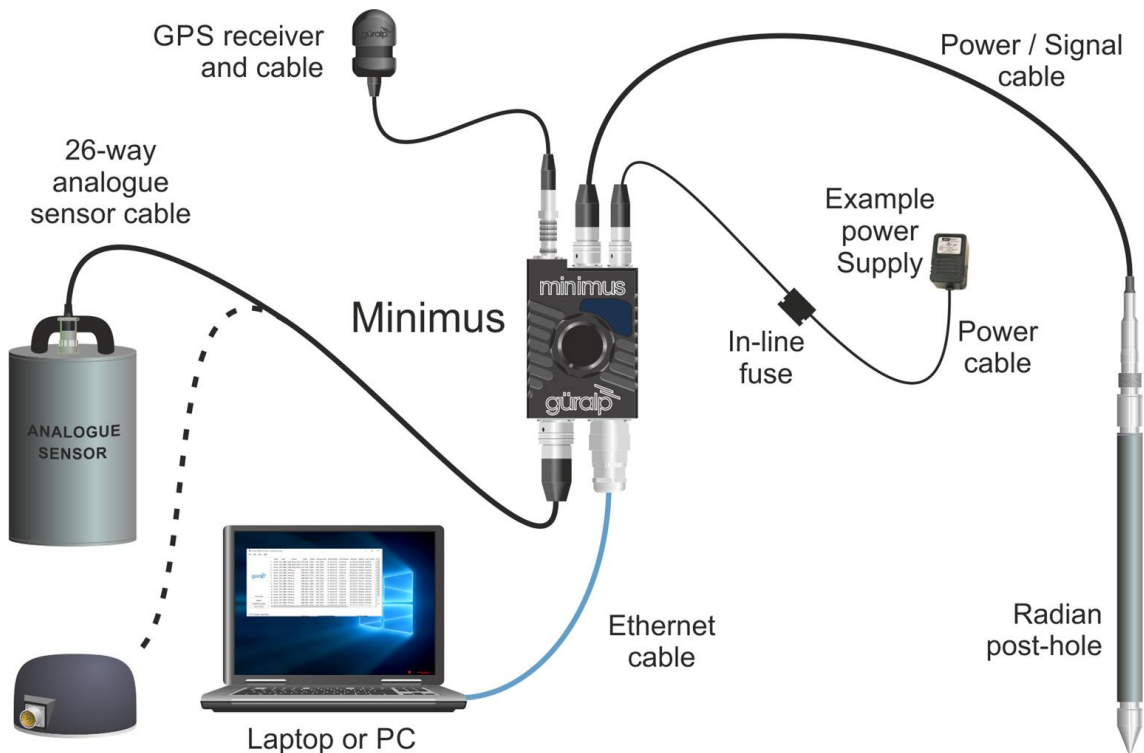

To get started, connect the cables as shown in the figure above. Power up the Minimus using a power supply with a DC output of between 10 and 36 Volts. We recommend fitting an in-line 3.5 A anti-surge fuse in the positive power lead to protect the external wiring of the installation. The Minimus will, in turn, provide power to all connected instruments.



**Caution:** Observe the correct polarity when connecting the power supply. The **red** lead (from pin B) must be connected to the **positive terminal**, typically labelled "+", and the **black** lead (from pin A) must be connected to the **negative terminal**, typically labelled "-". An incorrect connection risks destroying the digitiser, the power supply and any connected instruments.

### 1.1.4 Instrument and Channel Names

The tables in this section are designed to inform users of the names and codes of the streamed and recorded channels. The first character of a miniSEED channel code represents the sample rate. The possible values are shown in the table below:

Code	Sample Rate
<b>F</b>	$\geq 1000$ Hz to $< 5000$ Hz
<b>C</b>	$\geq 250$ Hz to $< 1000$ Hz
<b>H</b>	$\geq 80$ Hz to $< 250$ Hz
<b>B</b>	$\geq 10$ Hz to $< 80$ Hz
<b>M</b>	$> 1$ to $< 10$
<b>L</b>	$\approx 1$

## Minimus, Minimus+, Fortimus, Certimus

<b>V</b>	≈ 0.1 Hz
<b>U</b>	≈ 0.01 Hz
<b>R</b>	≥ 0.0001 Hz to < 0.001



**Note:** Throughout this section, the letter *n* in italic script is used to indicate the Sensor number, which is a small integer used to identify the signal source. This is always zero ('0') for the Minimus' own internal sensors and for the first analogue instrument (Sensor0).

For Minimus units, Sensors 1, 2, ... 8 are external Radian instruments in a string sharing a digital connection. Sensor1 is the digital instrument closest to the Minimus.

 For Minimus+ units, Sensor 1 is the second analogue sensor. Sensors 2, 3, ... 9 are external Radian instruments in a string sharing a digital connection. Sensor2 is the digital instrument closest to the Minimus+.

### 1.1.4.1 Minimus Internal Sensors

The names of recorded seismic and accelerometer channels are suffixed with "A" or "B". This notation distinguishes between the two different sample rates that is possible to configure for each recorded channel. For example, the recorded streams *S0AccZA* and *S0AccZB* carry digitisations of the same signal, differing only in the sample rate. The below table shows the channels available from a Minimus with no external sensor attached.

Sensor	Comp.	Digital filter mode	Data streaming		Data recording	
			Live stream name	Live Stream code	Data record name	Mini SEED channel code
MEMS accelerometer	1	Acausal	S0AccZ	0AXL10	S0AccZA	xN1
		Causal	S0AccZLowLat	0AXL1C	S0AccZB	xN1
	2	Acausal	S0AccN	0AXL20	S0AccNA	xN2
		Causal	S0AccNLowLat	0AXL2C	S0AccNB	xN2
	3	Acausal	S0AccE	0AXL30	S0AccEA	xN3
		Causal	S0AccELowLat	0AXL3C	S0AccEB	xN3
Magnetometer	1	Acausal	S0MagZ	0MAG10	S0MagZ	xF1
	2	Acausal	S0MagN	0MAG20	S0MagN	xF2
	3	Acausal	S0MagE	0MAG30	S0MagE	xF3
Input voltage		Acausal	S0Voltage	0VINP0	S0Voltage	xYV

## Minimus, Minimus+, Fortimus, Certimus

Sensor	Comp.	Data streaming			Data recording	
		Digital filter mode	Live stream name	Live Stream code	Data record name	Mini SEED channel code
Power						
Humidity within the Minimus		Acausal	S0HumidA	0HUMA0	S0HumidA	xIO
Temperature	Precision temperature	Acausal	S0TemprA	0TMPA0	S0TemprA	xKO
	First derivative of temperature	Acausal	S0TemprD	0TMPD0		xKD
Internal Clock	Internal clock offset from GNSS	Acausal	ClkGpsOffset	0CGPS0	ClkGpsOffset	BEO
	Internal clock period difference from GNSS	Acausal	ClkGpsPeriod	0CGPSP	ClkGpsPeriod	BEF
	Internal clock DAC frequency pulling	Acausal	ClkDacFreqPull	0CVDAC	ClkDacFreqPull	BED
	Test internal clock drift	Acausal	ClkTestPpbS	0CTSTB	ClkTestPpbS	BEB
	Internal clock offset from PTP	Acausal	ClkPtpOffset	0CPTPO	ClkPtpOffset	BEP
	Delay MS	Acausal	ClkPtpDelayMS	0CPDMS	ClkPtpDelayMS	BEA
	Delay SM	Acausal	ClkPtpDelaySM	0CPDSM	ClkPtpDelaySM	BEB
	Mean path delay	Acausal	ClkPtpMeanPathDelay	0CPMPD	ClkPtpMeanPathDelay	BEC

### 1.1.4.2 Connected Analogue Instruments

Analogue Instruments connected to a Minimus have a standard set of codes pre-programmed. These are dependant on the type of instrument configured: a velocimeter will show with the prefix *VEL* whilst an accelerometer will show as *ACC*. The following table shows a full list of the values associated with each component of these sensors.

Minimus, Minimus+, Fortimus, Certimus

Sensor	Comp.	Data streaming			Data recording		
		Digital filter mode	Live stream name	Live Stream code	Data record name	Mini SEED channel code	
Analogue seismic sensor (velocimeter or accelerometer)	Vertical	Acausal	<i>S<i>n</i>SeisZ</i>	<i>n</i> VELZ0 or <i>n</i> ACCZ0	<i>S<i>n</i>SeisZA</i>	xHZ or xNZ	
			<i>S<i>n</i>SeisZ</i>	<i>n</i> VELZ2 or <i>n</i> ACCZ2	<i>S<i>n</i>SeisZB</i>	xHZ or xNZ	
		Causal	<i>S<i>n</i>SeisZLowLat</i>	<i>n</i> VELZC or <i>n</i> ACCZC	<i>S<i>n</i>SeisZLowLat</i>	xHZ or xNZ	
	North	Acausal	<i>S<i>n</i>SeisN</i>	<i>n</i> VELN0 or <i>n</i> ACCN0	<i>S<i>n</i>SeisNA</i>	xHN or xNN	
			<i>S<i>n</i>SeisN</i>	<i>n</i> VELN2 or <i>n</i> ACCN2	<i>S<i>n</i>SeisNB</i>	xHN or xNN	
		Causal	<i>S<i>n</i>SeisNLowLat</i>	<i>n</i> VELNC or <i>n</i> ACCNC	<i>S<i>n</i>SeisNLowLat</i>	xHN or xNN	
	East	Acausal	<i>S<i>n</i>SeisE</i>	<i>n</i> VELE0 or <i>n</i> ACCE0	<i>S<i>n</i>SeisEA</i>	xHE or xNE	
			<i>S<i>n</i>SeisE</i>	<i>n</i> VELE2 or <i>n</i> ACCE2	<i>S<i>n</i>SeisEB</i>	xHE or xNE	
		Causal	<i>S<i>n</i>SeisELowLat</i>	<i>n</i> VELEC or <i>n</i> ACCEC	<i>S<i>n</i>SeisELowLat</i>	xHE or xNE	
	Auxiliary input		Acausal	<i>S<i>n</i>SeisX</i>	<i>n</i> AUXX0	<i>S<i>n</i>SeisX</i>	xDF
	Analogue seismic sensor mass positions	Vertical	Acausal	<i>S<i>n</i>IntZ</i>	<i>n</i> VELM8	<i>S<i>n</i>IntZ</i>	xMZ
		North	Acausal	<i>S<i>n</i>IntN</i>	<i>n</i> VELM9	<i>S<i>n</i>IntN</i>	xMN
East		Acausal	<i>S<i>n</i>IntE</i>	<i>n</i> VELMA	<i>S<i>n</i>IntE</i>	xME	
Calibration Channel		Acausal	<i>S<i>n</i>Calib</i>	<i>n</i> VELC (or <i>n</i> ACCC)	<i>S<i>n</i>Calib</i>	xCA	
Humidity within sensor enclosure		Acausal	<i>S<i>n</i>HumidB</i>	<i>n</i> HUMB0	<i>S<i>n</i>HumidB</i>	xIO	
Pressure	Within sensor enclosure	Acausal	<i>S<i>n</i>Pressure</i>	<i>n</i> PRSR0	<i>S<i>n</i>Pressure</i>	xDI	
	External	Acausal	<i>S<i>n</i>ExtPressure</i>	<i>n</i> PRSR1	<i>S<i>n</i>ExtPressure</i>	xDO	
PLL clock offset		Acausal	<i>S<i>n</i>PLLOffset</i>	<i>n</i> PLLO0	<i>S<i>n</i>PLLOffset</i>	xYO	

### 1.1.4.3 Connected Digital Instruments

Digital instruments can be attached to the Minimus in series. The lowest numbered instrument is the one which to the Minimus. On a Minimus, this will be shown as Sensor1. On a Minimus+, this will be shown as Sensor2. The following table shows the pre-configured channel names for each component:

Sensor	Comp	Digital filter mode	Data streaming		Data recording		
			Live stream name	Live stream code	Data record name	MiniSEED channel code	
Seismometer (velocity or acceleration response)	Vertical	Acausal	<i>SnSeisZ</i>	<i>nVELZ0</i> or <i>nACCZ0</i>	<i>SnSeisZA</i>	xHZ or xNZ	
			<i>SnSeisZ</i>	<i>nVELZ2</i> or <i>nACCZ2</i>	<i>SnSeisZB</i>	xHZ or xNZ	
		Causal	<i>SnSeisZLowLat</i>	<i>nVELZC</i> or <i>nACCZC</i>	<i>SnSeisZLowLat</i>	xHZ or xNZ	
	North	Acausal	<i>SnSeisN</i>	<i>nVELN0</i> or <i>nACCN0</i>	<i>SnSeisNA</i>	xHN or xNN	
			<i>SnSeisN</i>	<i>nVELN2</i> or <i>nACCN2</i>	<i>SnSeisNB</i>	xHN or xNN	
		Causal	<i>SnSeisNLowLat</i>	<i>nVELNC</i> or <i>nACCNC</i>	<i>SnSeisNLowLat</i>	xHN or xNN	
	East	Acausal	<i>SnSeisE</i>	<i>nVELE0</i> or <i>nACCE0</i>	<i>SnSeisEA</i>	xHE or xNE	
			<i>SnSeisE</i>	<i>nVELE2</i> or <i>nACCE2</i>	<i>SnSeisEB</i>	xHE or xNE	
		Causal	<i>SnSeisELowLat</i>	<i>nVELEC</i> or <i>nACCEC</i>	<i>SnSeisELowLat</i>	xHE or xNE	
	Digital seismic sensor mass position	Vertical	Acausal	<i>SnIntZ</i>	<i>nINTZ0</i>	<i>SnIntZ</i>	xMZ
		North	Acausal	<i>SnIntN</i>	<i>nINTN0</i>	<i>SnIntN</i>	xMN
		East	Acausal	<i>SnIntE</i>	<i>nINTE0</i>	<i>SnIntE</i>	xME
MEMS accelerometer	Vertical	Acausal	<i>SnAccZ</i>	<i>nAXLZ0</i>	<i>SnAccZA</i>	xNZ	
			<i>SnAccZ</i>		<i>SnAccZB</i>	xNZ	
	Causal	<i>SnAccZLowLat</i>	<i>nAXLZC</i>		xNZ		
	North	Acausal	<i>SnAccN</i>	<i>nAXLN0</i>	<i>SnAccNA</i>	xNN	
<i>SnAccN</i>				<i>SnAccNB</i>	xNN		

Minimus, Minimus+, Fortimus, Certimus

Sensor	Comp	Data streaming			Data recording	
		Digital filter mode	Live stream name	Live stream code	Data record name	MiniSEED channel code
		Causal	<i>Sn</i> AccNLowLat	<i>n</i> AXLNC		xNN
	East	Acausal	<i>Sn</i> AccE	<i>n</i> AXLE0	<i>Sn</i> AccEA	xNE
					<i>Sn</i> AccEB	xNE
	Causal	<i>Sn</i> AccELowLat	<i>n</i> AXLEC		xNE	
Magnetometer	Z	Acausal	<i>Sn</i> MagZ	<i>n</i> MAGZ0	<i>Sn</i> MagZ	xFZ
	N	Acausal	<i>Sn</i> MagN	<i>n</i> MAGN0	<i>Sn</i> MagN	xFN
	E	Acausal	<i>Sn</i> MagE	<i>n</i> MAGE0	<i>Sn</i> MagE	xFE
	Yaw	Acausal	<i>Sn</i> RotYaw	<i>n</i> ROTY0	<i>Sn</i> RotYaw	xYY
	Pitch	Acausal	<i>Sn</i> RotPitch	<i>n</i> ROTP0	<i>Sn</i> RotPitch	xYP
	Roll	Acausal	<i>Sn</i> RotRoll	<i>n</i> ROTR0	<i>Sn</i> RotRoll	XYR
Temperature		Acausal	<i>Sn</i> TemprB	<i>n</i> TMPB0	Sensor <i>n</i> TemprBRough	xKO
Humidity within sensor enclosure		Acausal	<i>Sn</i> HumidB	<i>n</i> HUMB0	<i>Sn</i> HumidB	xIO
Pressure	Within sensor enclosure	Acausal	<i>Sn</i> Pressure	<i>n</i> PRSR0	<i>Sn</i> Pressure	xDI
	External	Acausal	<i>Sn</i> ExtPressure	<i>n</i> PRSR1	<i>Sn</i> ExtPressure	xDO
PLL clock offset		Acausal	<i>Sn</i> PLLOffset	<i>n</i> PLLO0	<i>Sn</i> PLLOffset	xYO
Sensor power		Acausal	<i>Sn</i> Power	<i>n</i> PWR0	<i>Sn</i> Power	xE0
Sensor input voltage		Acausal	<i>Sn</i> Voltage	<i>n</i> VOLT0	<i>Sn</i> Voltage	xE1

## 1.1.5 Technical Drawings

### 1.1.5.1 *Minimus*

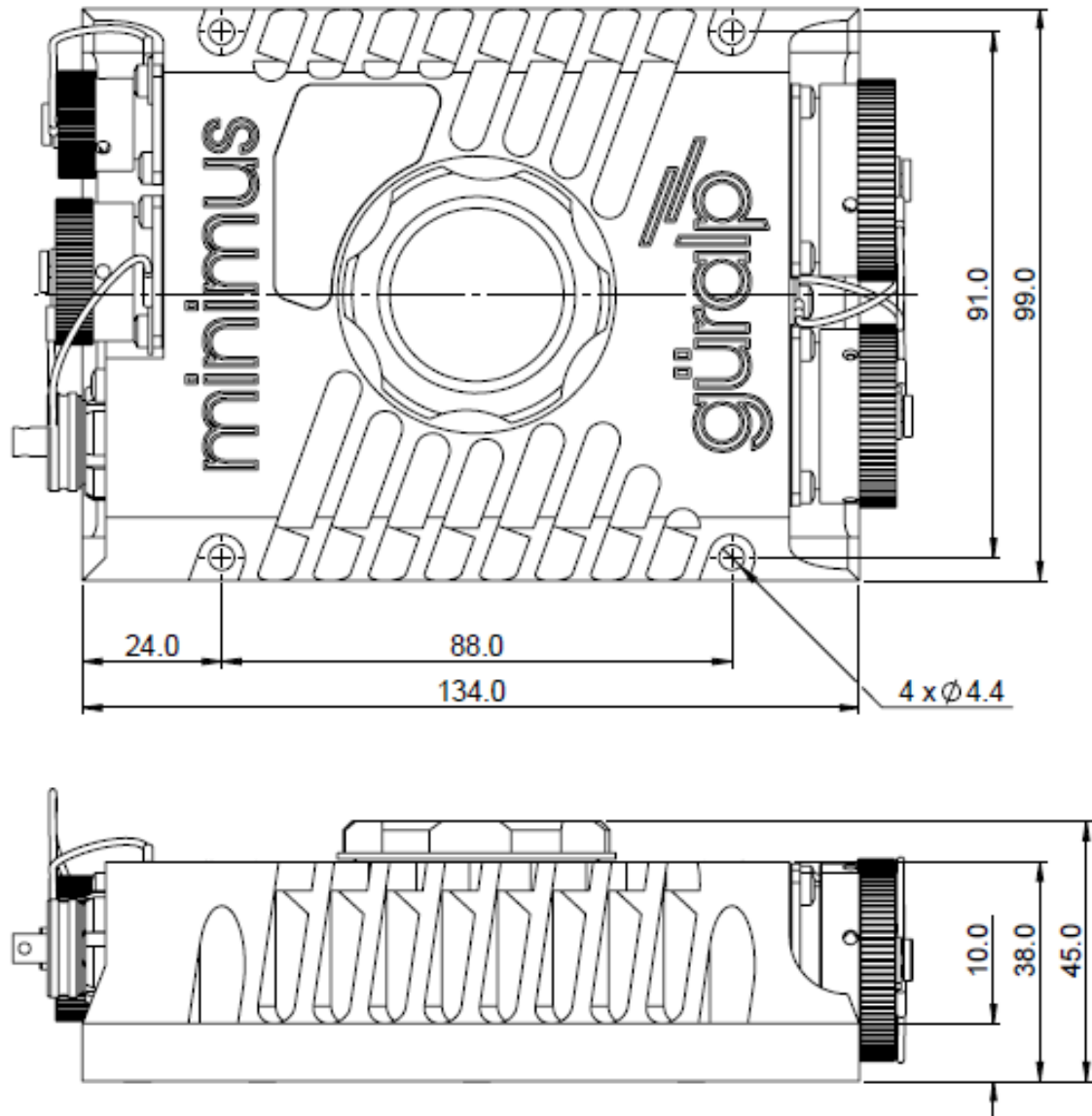

1.1.5.2 *Minimus+*

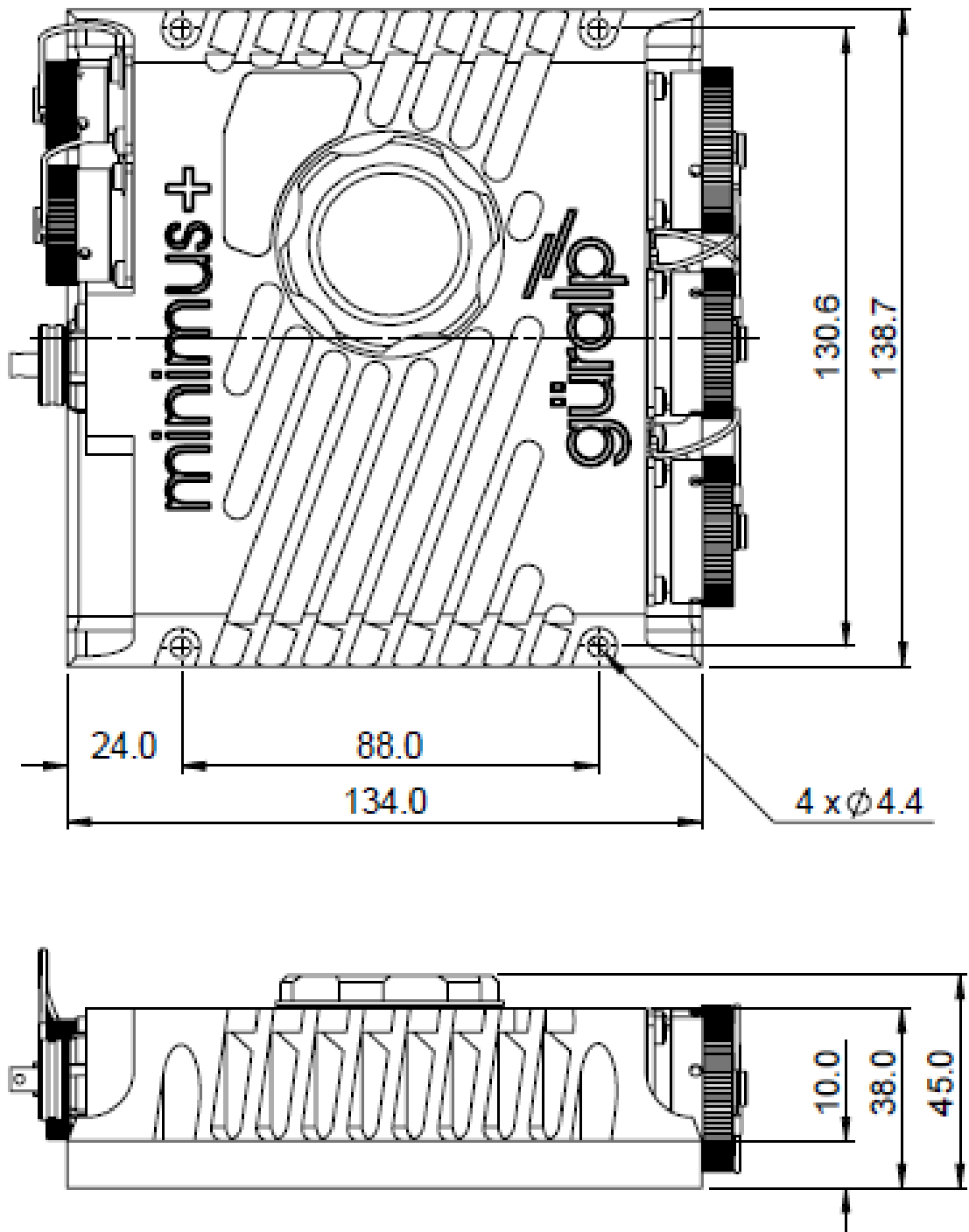



## 1.2 Fortimus

---

### 1.2.1 System Overview

Thank you for purchasing a Güralp Fortimus digital accelerometer.

This section describes the key components of a Fortimus system. The Fortimus unit is the main, standard product in the system; other components and accessories are optional and can be purchased separately. Please check your order confirmation to see which components were purchased with your system.

---

#### 1.2.1.1 Key Features

- Digital, three-axis, strong-motion, force-feedback accelerometer.
- Flat response to ground acceleration from DC to 315 Hz.
- Selectable gains for full-scale readings of  $\pm 4$  g,  $\pm 2$  g,  $\pm 1$  g and  $\pm 0.5$  g.
- 24-bit digitiser with a nominal sensitivity of  $0.578 \mu\text{V}$  per count.
- Selectable sample rates from 1 sample per hour to 5000 samples per second.
- Data streaming in real-time using GCF (Scream!), GDI-link and SEEDlink.
- Compact form, measuring just  $165 \times 165 \times 84$  mm.
- Internal  $\pm 2$  g MEMS accelerometer for orientation.
- Identification of I.P. address via Güralp Discovery software and, optionally, a cloud-based or organisational registry server.
- Remote instrument and data management via Discovery software.
- GüVü Android app for installation integrity checking via Bluetooth.
- Low-latency mode for Earthquake Early Warning ( $<40$  ms).
- Hot-swappable data storage with dual redundant microSD cards.
- GNSS time-synchronisation, compatible with Navstar (GPS), GLONASS, BeiDou and Galileo constellations, with PTP available as an alternative time source.
- Touch-sensitive, 2.4 inch colour LCD for monitoring and control operations.

---

#### 1.2.1.2 Typical Applications

- Earthquake Early Warning systems.
- Multi-scale seismic networks and arrays.
- Structural health monitoring (e.g. dams, industry, buildings).
- Surface and vault installation.
- Posthole deployment.

## 1.2.2 System Description

### 1.2.2.1 *Güralp Fortimus Digital Accelerometer*

The Güralp Fortimus is a Fortis triaxial accelerometer combined with a Minimus digitiser. The Minimus acquires data from and allows direct control of the Fortis analogue instrument.

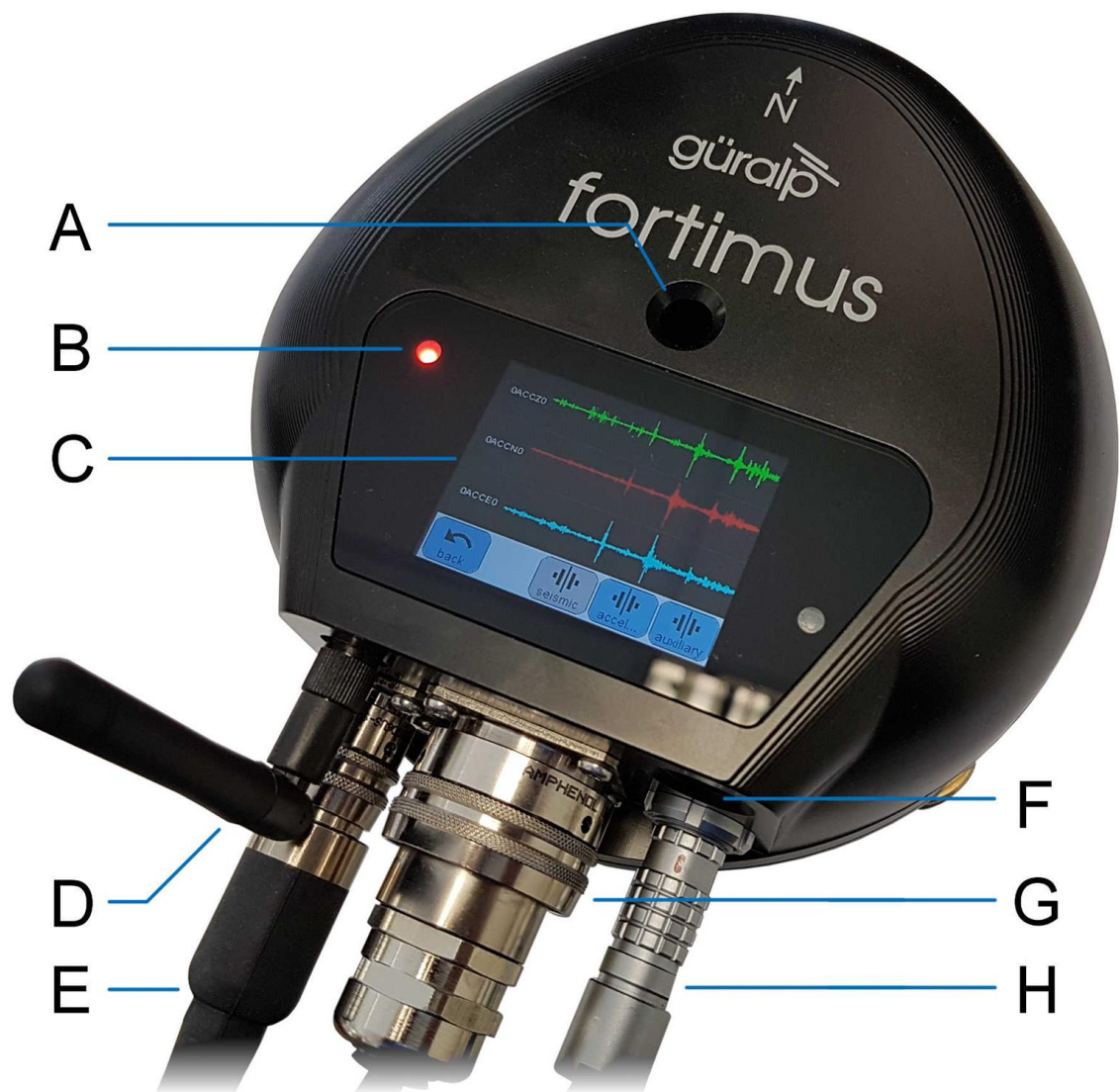

The labelled parts are:

- |          |                          |          |                     |
|----------|--------------------------|----------|---------------------|
| <b>A</b> | Hole for a mounting bolt | <b>E</b> | Power connection    |
| <b>B</b> | Status LED               | <b>F</b> | Cover for SD card   |
| <b>C</b> | Touch-screen display     | <b>G</b> | Ethernet connection |
| <b>D</b> | WiFi antenna             | <b>H</b> | GNSS connection     |

The hard-anodised aluminium casing protects the instrument from water, allowing it to be deployed in a range of environments. Installation is simple, using a single fixing bolt to attach the sensor to a hard surface. If required, you can also level the sensor

using its adjustable levelling feet. An integrated digital bubble-level – available in the display menu – provides quick visual feedback during levelling.

---

### 1.2.2.2 *Liquid Crystal Display*

The Fortimus is equipped with a multi-touch sensitive, 2.4 inch, full colour LCD touch-screen which displays waveforms and a virtual instrument level. Its menu system allows control of instrument state of health, gain settings and network configurations.

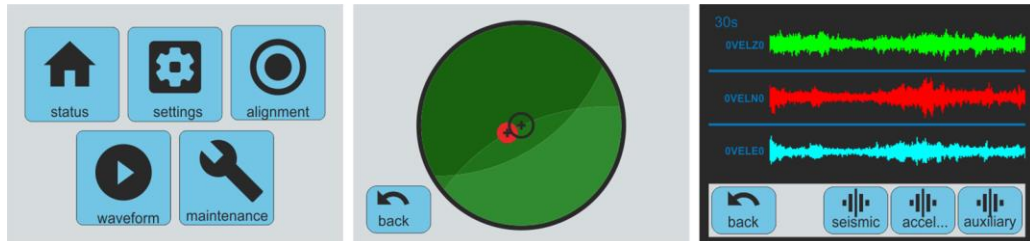

The LCD features are described in detail in Chapter 2.16 .

---

### 1.2.2.3 *LED Indicator*

The Fortimus has an LED indicator on the upper surface, which provides status and configuration information. More details can be found in Chapter 1.1.2.2.

---

### 1.2.2.4 *Bluetooth Connectivity*

The Fortimus features Bluetooth connectivity, allowing sensor and state-of-health information to be monitored using the Güralp GüVü app running on an Android mobile phone or tablet. For full details and features of the app see Chapter 2.17 .

Bluetooth can be disabled via software to save processing power, but the hardware module cannot be switched off. BLE (Bluetooth Low Energy) technology is used to minimise the power. The Bluetooth transmitter/receiver is in permanent standby mode and is always ready to receive a connection from a phone or tablet.

---

### 1.2.2.5 *MEMS Accelerometer*

The Fortimus digital accelerometer is equipped with a triaxial Micro Electro-Mechanical System (MEMS) accelerometer with a measurement range of  $\pm 2$  g. The three axes of sensitivity, Z, N and E, align with those of the main accelerometer outputs and are orientated as illustrated below:

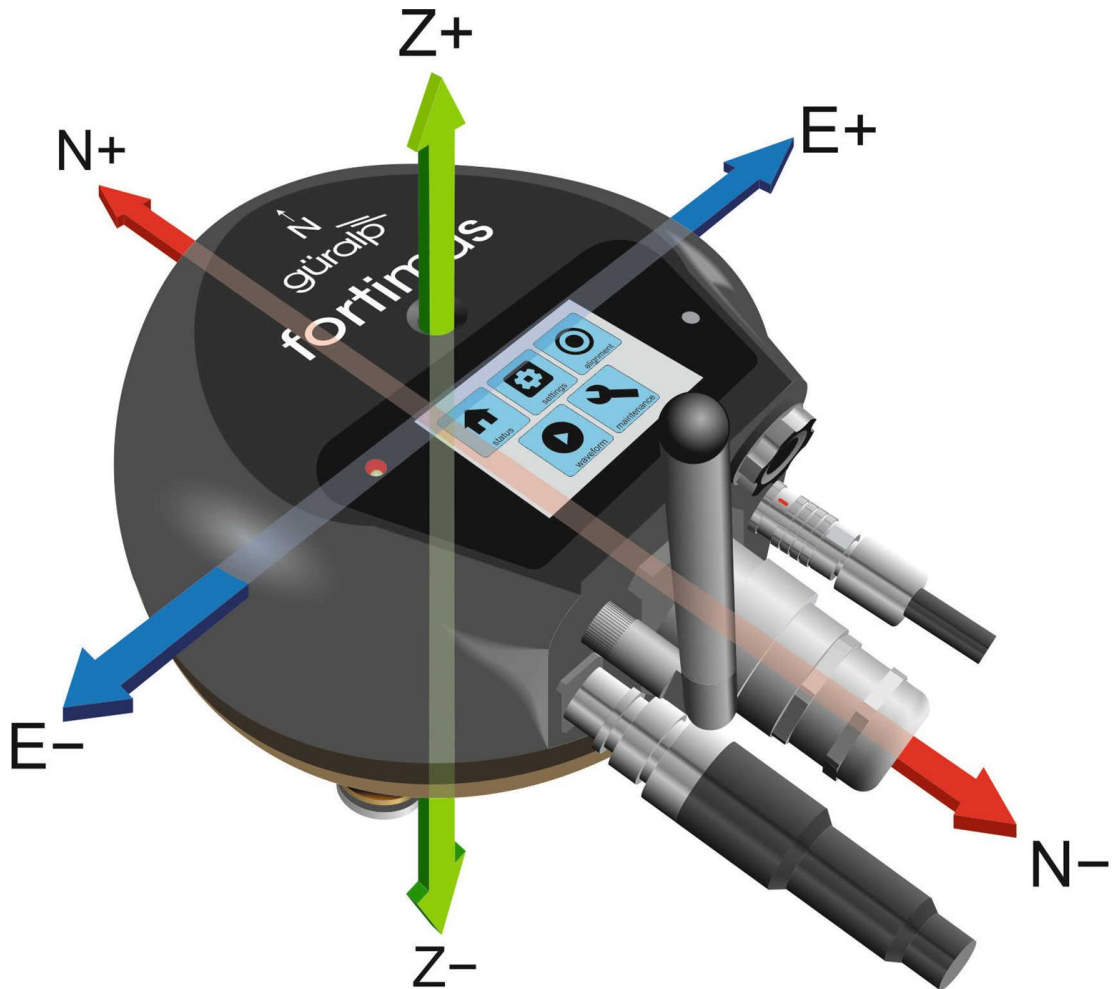

### 1.2.2.6 Data Storage

The Fortimus uses microSD (non-volatile) memory technology to store seismic data within the instrument. The Fortimus features two such microSD cards in order to provide redundancy; this helps to protect the recorded data in the unlikely event of any corruption or problem with the memory cards. One card is internal and cannot be removed by the user; the other is hot-swappable and easily accessible from the external SD card port.

The Fortimus is supplied with two microSD cards that are of equal storage capacity (e.g. two 16 GB cards).

## Primary (Hot-Swappable) microSD Card

To remove the external microSD card, follow the steps below:

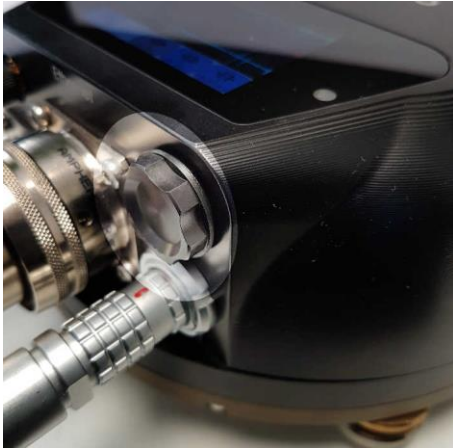

The microSD card is protected by a screw-in cap, located next to the Ethernet connector and above the GNSS connector



Remove the cap by unscrewing it anticlockwise, as shown.



**Caution:** Finger pressure is sufficient. Do not use tools.



The horizontal edge of the microSD card is now visible



The card slot has a spring lock: pushing the card firmly inwards locks it into place; a second push releases the card so that it can be withdrawn.

Lightly push the edge of the microSD card with a fingertip or a soft implement. Once the initial spring resistance has been overcome, release the pressure and the card will partially eject itself.



## Minimus, Minimus+, Fortimus, Certimus



The card should now protrude enough that it can be grasped and withdrawn.

To replace the card, ensure any existing card has been removed, as shown previously, then follow the steps below:



Gently insert the replacement card into the slot with the logo facing upwards and the straight edge of the card on the left, as shown. The card must be perfectly horizontal in order to align properly.



Push the card gently into place until the pressure of the spring lock is felt. If it does not glide into place, remove the card, and start again. Do not force the card into position.

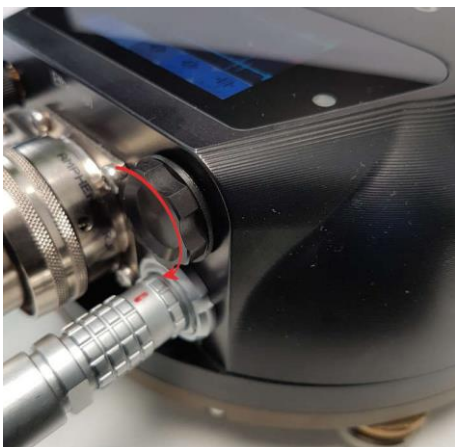

Check that the card is fully engaged by pressing lightly to unlock it and then pressing again to lock it. The card should be engaged firmly when locked and slide freely otherwise. Ensure the card is locked before proceeding.

Place the screw cap on the opening, taking great care to align the screw-thread correctly. Tighten the cap by screwing it in clockwise, as shown.



**Caution:** Finger pressure is sufficient. Do not use tools.



**Note:** In order to ensure data integrity and security, Güralp only recommend using the supplied industrial-grade microSD cards.



**Caution:** When the external microSD card is removed, the internal card keeps recording data, unless recording is stopped using the **Unmount Cards** button (see Chapter 2.3.4). However, when the external card is re-connected, any data written to the internal card while the removable card was absent will be overwritten.

## Internal (Backup) microSD Card

The second microSD card is factory-installed in a slot inside the Fortimus.



**Caution:** The internal microSD card is not accessible by the user. Attempts to remove or replace it will void the Fortimus' warranty.

### 1.2.2.7 WiFi Connectivity

The Fortimus is provided with a Siretta Delta 7A omnidirectional antenna, suitable for both 2.4 GHz and 5.8 GHz networks.



The antenna connects directly to the Fortimus using an SMA connector. It can be removed and replaced with a high gain, directional antenna if required. To remove the antenna, grasp the knurled locking sleeve and turn anti-clockwise, as shown.

See Chapter 0 for further details on how to configure the Fortimus to connect to a wireless network.



**Note:** It is not necessary to have the antenna fitted if wireless operation is not required.

## 1.2.3 System Setup

The Fortimus is delivered in an environmentally friendly, flat-packable, suspension packaging. The packaging is specifically designed for the Fortimus and should be re-used whenever you need to transport the instrument. Before unpacking, please inspect the case for any signs of damage and report defects to [support@guralp.com](mailto:support@guralp.com). Unpack the equipment on a clean work surface. Within the package you will find: the Fortimus digital accelerometer, the pigtail power cable, the GNSS receiver and cable, the Ethernet cable and the fixing bolt.



**Caution:** Although the Fortimus is a strong motion instrument, it contains sensitive mechanical components which can be damaged by mishandling. If you are at all unsure about the handling or installation of the device, you should contact Guralp Systems for assistance.

- Do not bump or jolt any part of the sensor when handling or unpacking.
- Do not kink or walk on the data cable (especially on rough surfaces such as gravel), nor allow it to bear the weight of the sensor.
- Do not connect the instrument to a power source except where instructed.
- Never ground any of the output signal lines from the sensor.

Guralp highly recommends exploring and gaining familiarity with the Fortimus inside your lab before installation in an outdoors environment.

A typical set-up for the Fortimus is shown in the figure below:





To get started, connect the cables as shown in the figure above. Power up the Fortimus using a power supply with a DC output of between 10 and 36 Volts.



**Caution:** Observe the correct polarity when connecting the power supply. The **red** lead (from pin B) must be connected to the **positive terminal**, typically labelled "+", and the **black** lead (from pin A) must be connected to the **negative terminal**, typically labelled "-". An incorrect connection risks destroying the instrument, the power supply and any connected accessories.

## 1.2.4 Installation

### 1.2.4.1 Permanent Installation

You will need a hard, clean surface such as a concrete floor, to install the Fortimus.

If you are in any doubt about how to install the sensor, you should contact Guralp Systems' Technical Support, via [support@guralp.com](mailto:support@guralp.com).

1. Prepare the surface by scribing an accurate N/S orientation line and installing a grouted-in fixing bolt on the line, near the middle. An anchor terminating in a 6 mm or 8 mm ( $\frac{1}{4}$  or  $\frac{5}{16}$  inch) threaded stud is suitable.

The exposed thread should project approximately 100 mm (4 inches) above the surface. Significant excess length should be removed.

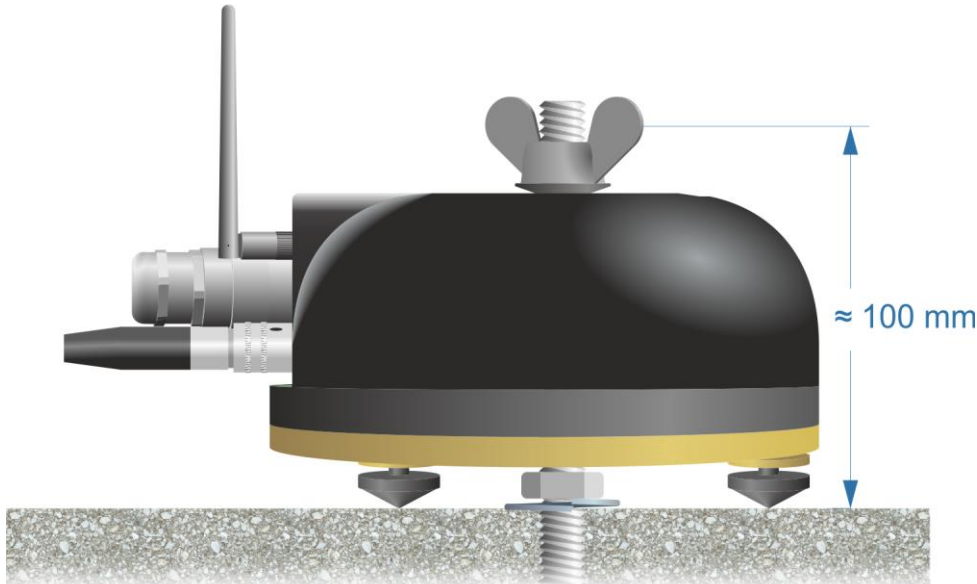

2. Place the Fortimus over the fixing bolt and rotate it to bring the scribed orientation line and Fortimus' pointers accurately into parallel alignment.

For more accurate alignment, a long, thin rod or a length of stiff wire can be aligned with a slot machined into the base of the instrument. It can be held in place by hand or, if preferred, by inserting two 3mm screws into the threaded holes provided.

## Minimus, Minimus+, Fortimus, Certimus

3. Connect all the cables as described in Chapter 1.2.3 and power on the Fortimus.
4. Touch the **alignment** button at the top right of the LCD screen: this will display the digital levelling tool



The red circle behaves like the bubble in a traditional bubble level, moving towards the highest edge of the instrument. The further from the centre it is, the more adjustment is needed.

5. Level the sensor, using its adjustable feet, until the red circle lies entirely within the inner circle of the indicator.

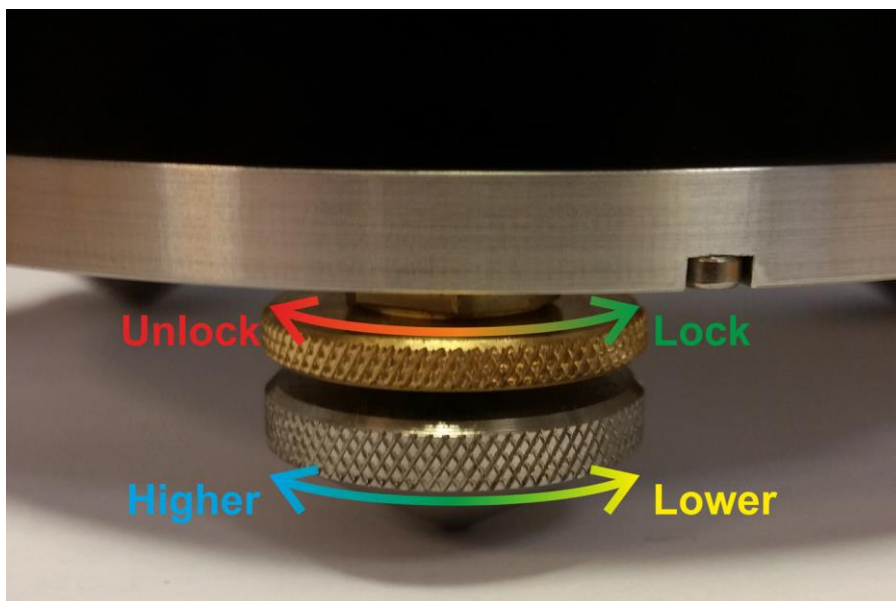

The feet are mounted on screw threads. To adjust the height of a foot, turn the brass locking nut clockwise (when viewed from above) to loosen it and rotate the entire foot so that it screws either in or out. When you are happy with the height, tighten the brass locking nut anti-clockwise to secure the foot.

6. Secure the instrument to the mounting stud using the conical washer provided and a wing nut.



**Caution:** Hand-tighten only, do not use tools.

The instrument is now installed and transducing ground motion.

### **1.2.4.2 Temporary Installations**

The Fortimus is ideal for monitoring vibrations at field sites, owing to its ruggedness, high sensitivity and ease of deployment. Temporary installations will usually be in hand-dug pits or machine drilled holes. Once a level base is made, the Fortimus can be sited there and covered with a box or bucket. One way to produce a level base is to use a hard-setting liquid:

1. Prepare a quick-setting cement/sand mixture and pour it into the hole.
2. "Puddle" the cement by vibrating it until it is fully liquefied, allowing its surface to level out.
3. Follow the cement manufacturer's instructions carefully. Depending on the temperature and type of cement used, the mixture will set over the next 2 to 12 hours.
4. Install the sensor as above, then cover and back-fill the emplacement with soil, sand, or polystyrene beads.
5. Cover the hole with a turf-capped board to exclude wind noise and to provide a stable thermal environment.

If you prefer, you can use quicker-setting plaster or polyester mixtures to provide a mounting surface. However, you must take care to prevent the liquid leaking away by "proofing" the hole beforehand. Dental plaster, or similar mixtures, may need reinforcing with sacking or muslin.

---

### **1.2.4.3 Installation in Hazardous Environments**

The fully enclosed, aluminium case design of the Fortimus makes it suitable for use in hazardous environments where electrical discharges due to the build-up of static charge could lead to the ignition of flammable gasses. To ensure safe operation in these conditions, the metal case of the instrument must be electrically bonded ('earthed') to the structure on which it is mounted, forming a path to safely discharge any static charge.

Where electrical bonding ('earthing') is required during the installation of a Fortimus, the central mounting hole that extends through the instrument should be used as the connection point. This is electrically connected to all other parts of the sensor case. Connection can be made by either a cable from a local earthing point terminated in an 8 mm ring tag or via the mounting bolt itself.

## 1.2.5 Instrument and Channel Names

The tables in this section are designed to inform users of the names and codes of the streamed and recorded channels present in the Fortimus. The first character of a miniSEED channel code represents the sample rate. The possible values are shown in the table below:

<b>F</b>	≥ 1000 Hz to < 5000 Hz
<b>C</b>	≥ 250 Hz to < 1000 Hz
<b>H</b>	≥ 80 Hz to < 250 Hz
<b>B</b>	≥ 10 Hz to < 80 Hz
<b>M</b>	> 1 to < 10
<b>L</b>	≈ 1
<b>V</b>	≈ 0.1 Hz
<b>U</b>	≈ 0.01 Hz
<b>R</b>	≥ 0.0001 Hz to < 0.001

### 1.2.5.1 Environmental Channels

Sensor	Comp.	Data streaming			Data recording	
		Digital filter mode	Live stream name	Live Stream code	Data record name	Mini SEED channel code
MEMS accelerometer	1	Acausal	S0AccZ	0AXL10	S0AccZA	xN1
		Causal	S0AccZLowLat	0AXL1C	S0AccZB	xN1
	2	Acausal	S0AccN	0AXL20	S0AccNA	xN2
		Causal	S0AccNLowLat	0AXL2C	S0AccNB	xN2
	3	Acausal	S0AccE	0AXL30	S0AccEA	xN3
		Causal	S0AccELowLat	0AXL3C	S0AccEB	xN3
Magnetometer	1	Acausal	S0MagZ	0MAG10	S0MagZ	xF1
	2	Acausal	S0MagN	0MAG20	S0MagN	xF2
	3	Acausal	S0MagE	0MAG30	S0MagE	xF3
Input voltage		Acausal	S0Voltage	0VINP0	S0Voltage	xYV
Digitiser power usage		Acausal	S0Power	0PINP0	S0Power	xYP

Sensor	Comp.	Data streaming			Data recording	
		Digital filter mode	Live stream name	Live Stream code	Data record name	Mini SEED channel code
Humidity	Relative within Minimus	Acausal	S0HumidA	0HUMA0	S0HumidA	xIO
	Within sensor enclosure	Acausal	S0HumidB	0HUMB0	S0HumidB	xIO
Pressure	Within sensor enclosure	Acausal	S <i>n</i> Pressure	<i>n</i> PRSR0	S <i>n</i> Pressure	xDI
	External	Acausal	S <i>n</i> ExtPressure	<i>n</i> PRSR1	S <i>n</i> ExtPressure	xDO
Temperature	Precision temperature	Acausal	S0TemprA	0TMPA0	S0TemprA	xKO
	First derivative of temperature	Acausal	S0TemprD	0TMPD0		xKD
Internal Clock	Internal clock offset from GNSS	Acausal	ClkGpsOffset	0CGPS0	ClkGpsOffset	BEO
	Internal clock period difference from GNSS	Acausal	ClkGpsPeriod	0CGPSP	ClkGpsPeriod	BEF
	Internal clock DAC frequency pulling	Acausal	ClkDacFreqPull	0CVDAC	ClkDacFreqPull	BED
	Test internal clock drift	Acausal	ClkTestPbpS	0CTSTB	ClkTestPpbS	BEB
	Internal clock offset from PTP	Acausal	ClkPtpOffset	0CPTPO	ClkPtpOffset	BEP
	Delay MS	Acausal	ClkPtpDelayMS	0CPDMS	ClkPtpDelayMS	BEA
	Delay SM	Acausal	ClkPtpDelaySM	0CPDSM	ClkPtpDelaySM	BEB
	Mean path delay	Acausal	ClkPtpMeanPathDelay	0CPMPD	ClkPtpMeanPathDelay	BEC
PLL clock offset		Acausal	S <i>n</i> PLLOffset	0PLLO0	S <i>n</i> PLLOffset	xYO

### 1.2.5.2 Accelerometer Channels

The names of recorded seismic and accelerometer channels are suffixed with “A” or “B”. This notation distinguishes between the two different sample rates that is possible to configure for each recorded channel. For example, the recorded streams *S0AccZA* and *S0AccZB* carry digitisations of the same signal, differing only in the sample rate. The below table shows the channels available from a Fortimus.

Minimus, Minimus+, Fortimus, Certimus

Sensor	Comp.	Data streaming			Data recording	
		Digital filter mode	Live stream name	Live Stream code	Data record name	Mini SEED channel code
Analogue accelerometer	Vertical	Acausal	S0SeisZ	0ACCZ0	S0SeisZA	xNZ
			S0SeisZ	0ACCZ2	S0SeisZB	xNZ
		Causal	S0SeisZLowLat	0ACCZC	S0SeisZLowLat	xNZ
	North	Acausal	S0SeisN	0ACCN0	S0SeisNA	xNN
			S0SeisN	0ACCN2	S0SeisNB	xNN
		Causal	S0SeisNLowLat	0ACCNC	S0SeisNLowLat	xNN
	East	Acausal	S0SeisE	0ACCE0	S0SeisEA	xNE
			S0SeisE	0ACCE2	S0SeisEB	xNE
		Causal	S0SeisELowLat	0ACCEC	S0SeisELowLat	xNE
Calibration channel		Acausal	S0Calib	0ACCC0		xCA

## 1.3 Certimus

---

### 1.3.1 System Overview

Thank you for purchasing a Güralp Certimus digital Seismometer.

This section describes the key components of a Certimus system. The Certimus other components and accessories are optional and can be purchased separately. Please check your order confirmation to see which components were purchased with your system.

---

#### 1.3.1.1 Key Features

- Digital, three-axis, weak-motion, force-feedback seismometer.
- Flat response to ground acceleration from 120s to 100 Hz.
- Standard gain equivalent to 2000V/ms-1.
- 24-bit digitiser with a nominal sensitivity of 0.2  $\mu$ V per count.
- Selectable sample rates from 1 sample per hour to 1000 samples per second.
- Data streaming in real-time using GCF (Scream!), GDI-link and SEEDlink.
- Compact form, measuring just 175 × 175 × 95 mm.
- Internal  $\pm 2$  g MEMS accelerometer for orientation.
- Identification of I.P. address via Güralp Discovery software and, optionally, a cloud-based or organisational registry server.
- Remote instrument and data management via Discovery software and/or WEB interface.
- Android app for installation integrity checking via Bluetooth.
- Low-latency mode for Earthquake Early Warning (< 40 ms).
- Hot swappable data storage with dual redundant microSD cards.
- GNSS time-synchronisation, compatible with Navstar (GPS), GLONASS, BeiDou and Galileo constellations, with PTP available as an alternative time source.
- Touch-sensitive, 2.4 inch colour LCD for monitoring and control operations.

---

#### 1.3.1.2 Typical Applications

- Earthquake Early Warning systems.
- Multi-scale seismic networks and arrays.
- Rapid response/aftershock study
- Surface and vault installation.
- Surface or buried deployment



## 1.3.2 System Description

### 1.3.2.1 *Güralp Certimus Digital Seismometer*

The Güralp Certimus is a broadband triaxial seismometer combined with a Minimus digitiser frontend. The Minimus acquires data from and allows direct control of the instrument.

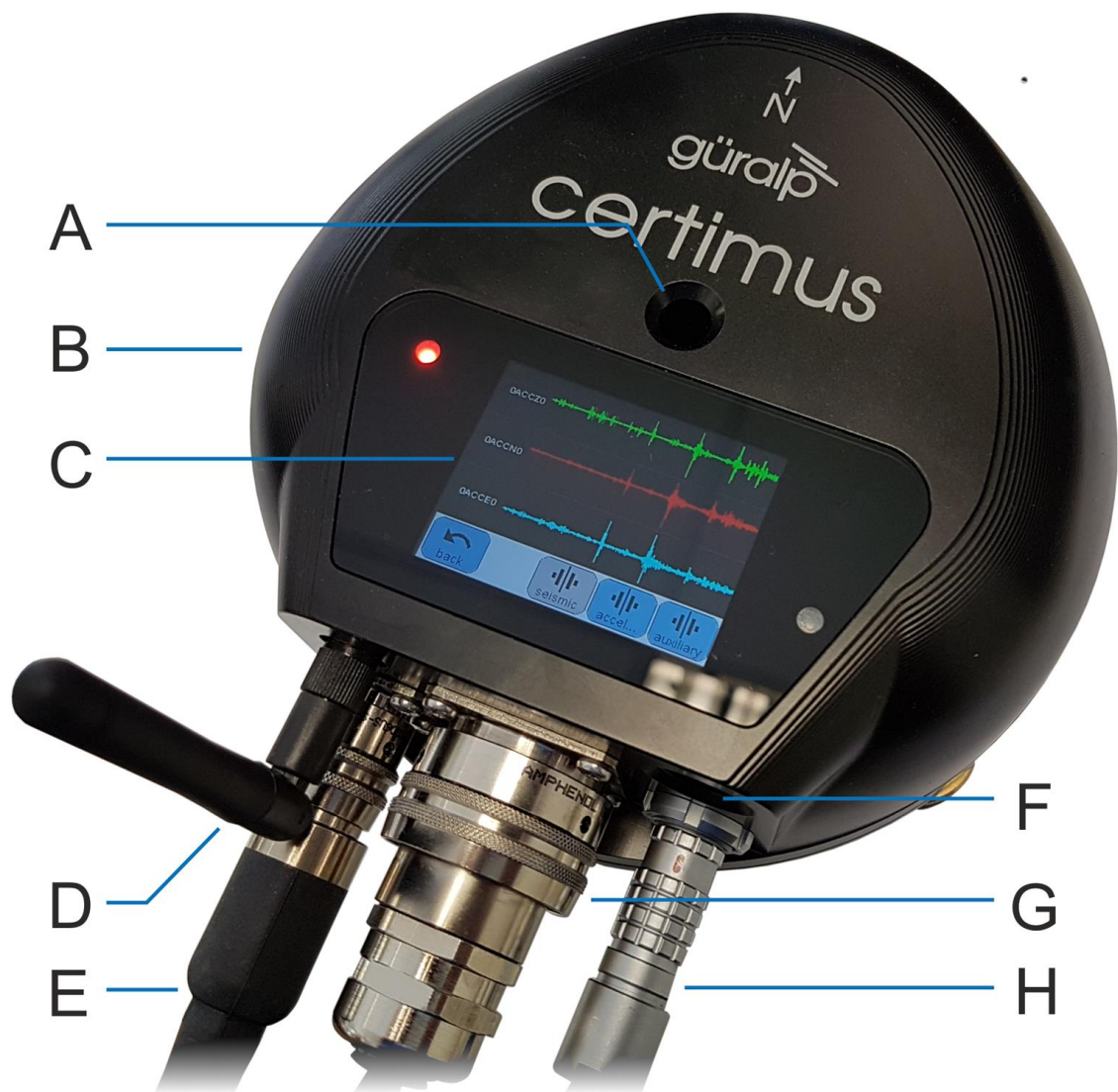

The labelled parts are:

- |          |                          |          |                     |
|----------|--------------------------|----------|---------------------|
| <b>A</b> | Hole for a mounting bolt | <b>E</b> | Power connection    |
| <b>B</b> | Status LED               | <b>F</b> | Cover for SD card   |
| <b>C</b> | Touch-screen display     | <b>G</b> | Ethernet connection |
| <b>D</b> | WiFi antenna             | <b>H</b> | GNSS connection     |

The hard-anodised aluminium casing protects the instrument from water, allowing it to be deployed in a range of environments. Installation is simple as the system will



## Minimus, Minimus+, Fortimus, Certimus

operate over a very wide range of angles. If required, you can also level the sensor using its adjustable levelling feet. An integrated digital bubble-level – available in the display menu – provides quick visual feedback during levelling. This is not essential for the operation of the sensor.



The Certimus is also available in a version without the LCD touch-screen, more suitable for direct burial.

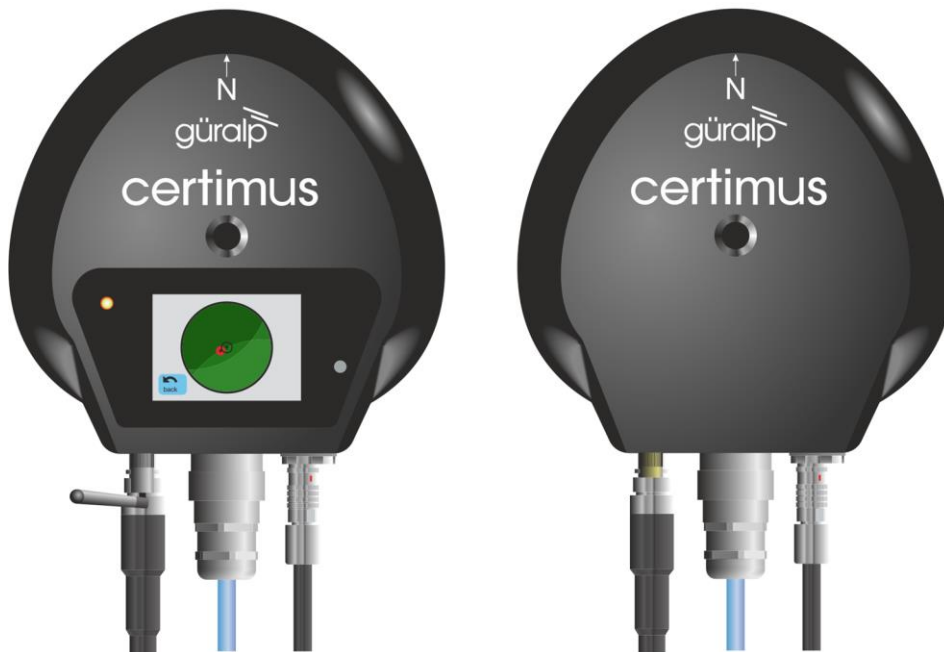

---

### 1.3.2.2 *Liquid Crystal Display*

The Certimus is equipped with a multi-touch sensitive, 2.4 inch, full colour LCD touch-screen which shows waveforms and a virtual instrument level. Its menu

system allows control of instrument state of health, gain settings and network configurations.

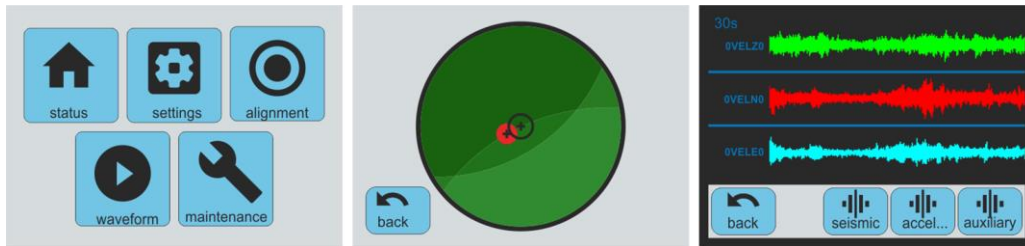

The LCD features are described in detail in Chapter 2.16 .

---

### 1.3.2.3 *LED Indicator*

The Certimus has an LED indicator on the upper surface, which provides status and configuration information. More details can be found in Chapter 2.11.1.

---

### 1.3.2.4 *Bluetooth Connectivity*

The Certimus features Bluetooth connectivity, allowing sensor and state-of-health data to be monitored using the Güralp GüVü app (see Chapter 2.17 ) running on an Android mobile phone or tablet.

Bluetooth can be disabled via software to save processing power but the hardware module cannot be switched off. BLE (Bluetooth Low Energy) technology is used to minimise the power requirement. The Bluetooth transmitter/receiver is in permanent standby mode and always ready to receive a connection from a phone or tablet.

---

### 1.3.2.5 *MEMS Accelerometer*

The Certimus digital seismometer is equipped with a triaxial Micro Electro-Mechanical System (MEMS) accelerometer with a measurement range of  $\pm 2$  g. The three axes of sensitivity, Z, N and E, align with those of the main seismometer outputs and are orientated as illustrated below:

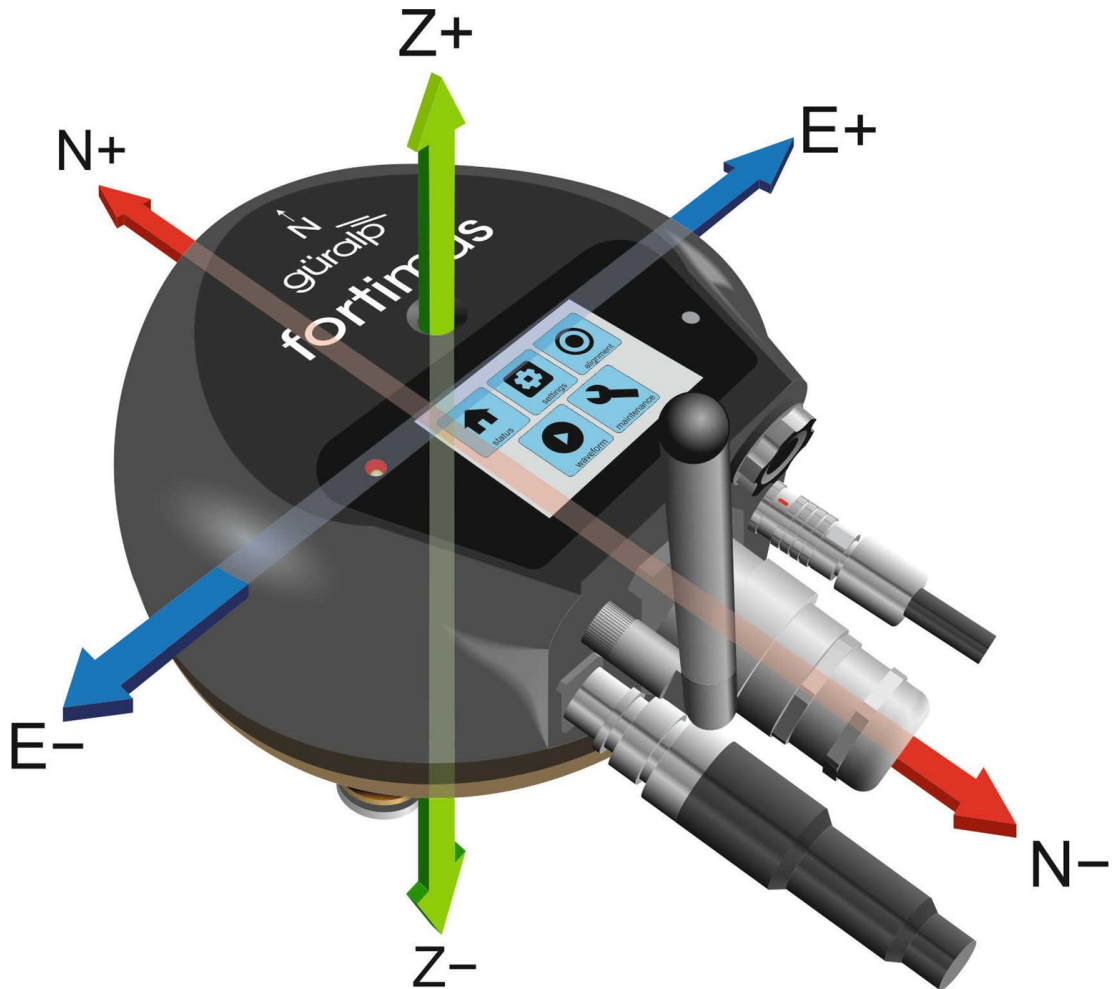

### 1.3.2.6 Data Storage

The Certimus uses microSD (non-volatile) memory technology to store seismic data within the instrument. The Certimus features two such microSD cards in order to provide redundancy; this helps to protect the recorded data in the unlikely event of any corruption or problem with the memory cards. One card is internal and cannot be removed by the customer; the other is hot-swappable and easily accessible from the external SD card port.

The Certimus is supplied with two microSD cards that are of equal storage capacity (e.g. two 16 GB cards).

## Primary (Hot-Swappable) microSD Card

To remove the external microSD card, follow the steps below:

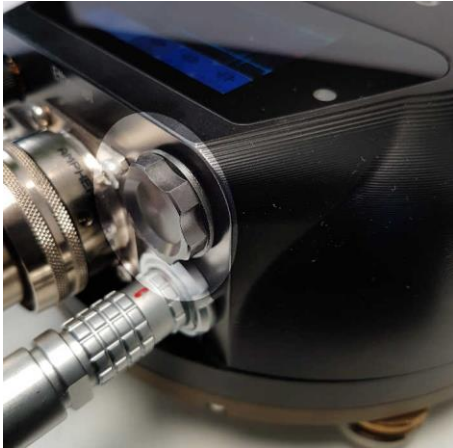

The microSD card is protected by a screw-in cap, located next to the Ethernet connector and above the GNSS connector



Remove the cap by unscrewing it anticlockwise, as shown.



**Caution:** Finger pressure is sufficient. Do not use tools.



The horizontal edge of the microSD card is now visible



The card slot has a spring lock: pushing the card firmly inwards locks it into place; a second push releases the card so that it can be withdrawn.

Lightly push the edge of the microSD card with a fingertip or a soft implement. Once the initial spring resistance has been overcome, release the pressure and the card will partially eject itself.

## Minimus, Minimus+, Fortimus, Certimus



The card should now protrude enough that it can be grasped and withdrawn.

To replace the card, ensure any existing card has been removed, as shown previously, then follow the steps below:



Gently insert the replacement card into the slot with the logo facing upwards and the straight edge of the card on the left, as shown. The card must be perfectly horizontal to align properly.



Push the card gently into place until the pressure of the spring lock is felt. If it does not glide into place, remove the card, and start again. Do not force the card into position.

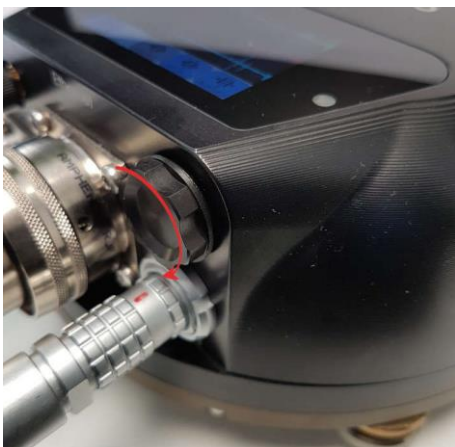

Check that the card is fully engaged by pressing lightly to unlock it and then pressing again to lock it. The card should be engaged firmly when locked and slide freely otherwise. Ensure the card is locked before proceeding.

Place the cap on the opening, taking care to align the screw-thread correctly. Replace the cap by screwing it in clockwise, as shown.



**Caution:** Finger pressure is sufficient. Do not use tools.





**Note:** In order to ensure data integrity and security, Güralp only recommend using the supplied industrial-grade microSD cards.



**Caution:** When the external microSD card is removed, the internal card keeps recording data, unless recording is stopped using the **Unmount Cards** button (see Chapter 2.3.4). However, when the external card is re-connected, any data written to the internal card while the removable card was absent will be overwritten.

### Internal (Backup) microSD Card

The second microSD card is factory-installed in a slot inside the Certimus.



**Caution:** The internal microSD card is not accessible by the user. Attempts to remove or replace it will void the Certimus' warranty.

#### 1.3.2.7 WiFi Connectivity

The Fortimus is provided with a Siretta Delta 7A omnidirectional antenna, suitable for both 2.4 GHz and 5.8 GHz networks.



The antenna connects directly to the Certimus using an SMA connector. It can be removed and replaced with a high-gain, directional antenna if required. To remove, grasp the knurled locking sleeve and turn anti-clockwise, as shown.

See Chapter 0 for further details on how to configure the Certimus to connect to a wireless network.



**Note:** It is not necessary to have the antenna fitted if wireless operation is not required.

### 1.3.3 System Setup

The Certimus is delivered in environmentally friendly, flat-packable, suspension packaging. The packaging is specifically designed for the Certimus and should be re-used whenever you need to transport the instrument. Before unpacking, please inspect the case for any signs of damage and report defects to [support@guralp.com](mailto:support@guralp.com). Unpack the equipment on a clean surface. The package should contain the Certimus digital seismometer, the pigtail power cable, the GNSS receiver and cable, the Ethernet cable and the fixing bolt.



**Caution:** The Certimus is a precision seismic sensor. It contains sensitive mechanical components which can be damaged by mishandling. If you are unsure about the handling or installation of this device, you should contact Guralp Systems at [support@guralp.com](mailto:support@guralp.com) for assistance.

- Do not bump or jolt any part of the sensor when handling or unpacking.
- Do not kink or walk on the data cable (especially on rough surfaces such as gravel), nor allow it to bear the weight of the sensor.
- Do not connect the instrument to a power source except where instructed.
- Never ground any of the output signal lines from the sensor.

Guralp highly recommends exploring and gaining familiarity with the Certimus inside your lab before installation in an outdoors environment.

A typical setup for the Certimus is shown in the figure below:



To get started, connect the cables as shown in the figure above. Power up the Certimus using a power supply with a DC output of between 10 and 36 Volts.



**Caution:** Observe the correct polarity when connecting the power supply. The **red** lead (from pin B) must be connected to the **positive terminal**, typically labelled "+", and the **black** lead (from pin A) must be connected to the **negative terminal**, typically labelled "-". An incorrect connection risks destroying the instrument, the power supply and any connected accessories.

## 1.3.4 Installation

### 1.3.4.1 Permanent Installation

You will need a hard, clean surface such as a concrete floor, to install the Fortimus.

If you are in any doubt about how to install the sensor, you should contact Gralp Systems' Technical Support, via [support@guralp.com](mailto:support@guralp.com).

1. Prepare the surface by scribing an accurate N/S orientation line and installing a grouted-in fixing bolt on the line, near the middle. An anchor terminating in a 6 mm or 8 mm ( $\frac{1}{4}$  or  $\frac{5}{16}$  inch) threaded stud is suitable.

The exposed thread should project approximately 100 mm (4 inches) above the surface. Significant excess length should be removed.

2. Place the Certimus on the surface and rotate it to bring the scribed orientation line and Certimus' pointers accurately into parallel alignment.

For more accurate alignment, a long, thin rod or a length of stiff wire can be aligned with a slot machined into the base of the instrument. It can be held in place by hand or, if preferred, by inserting two 3 mm screws into the threaded holes provided.

3. Connect all the cables as described in Chapter 1.3.3 and power on the Certimus.
4. Touch the **alignment** button at the top right of the LCD screen: This will display the digital levelling tool.



The red circle behaves like the bubble in a traditional bubble-level, moving towards the highest edge of the instrument. The further from the centre it is, the more adjustment is needed.



5. Level the sensor, using its adjustable feet, until the red circle lies entirely within the inner circle of the indicator.

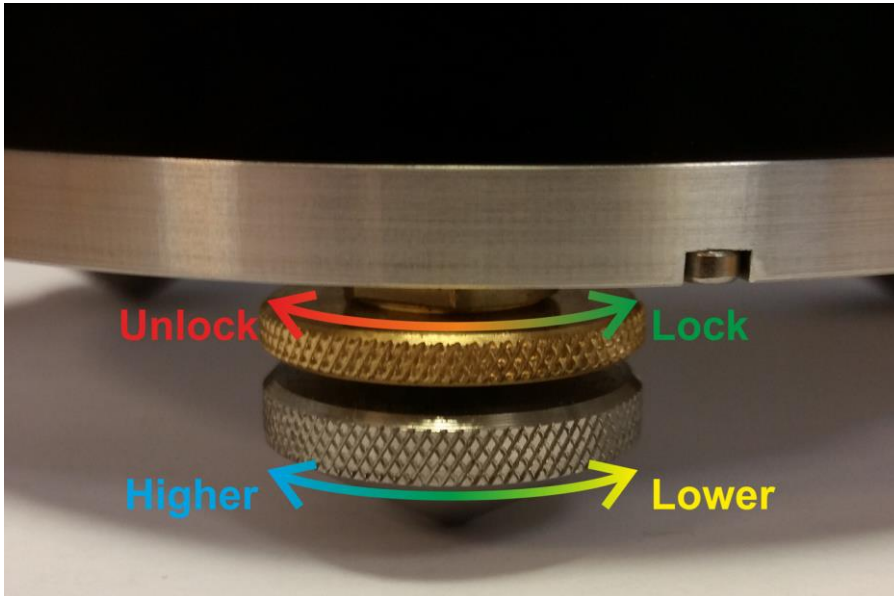

The feet are mounted on screw threads. To adjust the height of a foot, turn the brass locking nut clockwise (when viewed from above) to loosen it and rotate the entire foot so that it screws either in or out. When you are happy with the height, tighten the brass locking nut anti-clockwise to secure the foot.

6. Secure the instrument to the mounting stud using the conical washer provided and a wing nut.



**Caution:** Hand-tighten only: do not use tools.

The instrument is now installed and transducing ground motion.

### 1.3.4.2 *Temporary Installations*

The Certimus is ideal for monitoring vibrations at field sites, owing to its ruggedness, high sensitivity and ease of deployment. Temporary installations will usually be in hand-dug pits or machine drilled holes. Once a level base is made, the Certimus can be sited there and covered with a box or bucket. One way to produce a level base is to use a hard-setting liquid:

1. Prepare a quick-setting cement/sand mixture and pour it into the hole.
2. "Puddle" the cement by vibrating it until it is fully liquefied, allowing its surface to level out.
3. Follow the cement manufacturer's instructions carefully. Depending on the temperature and type of cement used, the mixture will set over the next 2 to 12 hours.

## Minimus, Minimus+, Fortimus, Certimus

4. Install the sensor as above, then cover and back-fill the emplacement with soil, sand, or polystyrene beads.
5. Cover the hole with a turf-capped board to exclude wind noise and to provide a stable thermal environment.

If you prefer, you can use quicker-setting plaster or polyester mixtures to provide a mounting surface. However, you must take care to prevent the liquid leaking away by “proofing” the hole beforehand. Dental plaster, or similar mixtures, may need reinforcing with sacking or muslin.

---

### 1.3.4.3 *Direct Burial*

The Certimus allows for deployment by burying it directly in the earth. This type of installation can be the simplest method, although, due to variations in ground types, means extra care needs to be taken to ensure the Certimus is protected from the elements and coupled stably with the ground. Guralp recommends that the Certimus is protected by placing it inside a plastic bag and covering with a sandbag before backfilling the hole with soil. The following list is Guralp’s recommended best practices and not an exhaustive guide, if in doubt please contact [support@guralp.com](mailto:support@guralp.com) for advice on your site:

1. Dig a hole deep enough to reach a compacted surface, if this is not possible then compact the earth yourself, or place a concrete slab at the bottom to spread the load across the surface,
2. Connect the cables to the Certimus and place it inside a plastic bag, ensuring none of the cables are coiled inside and that the opening to the bag is not putting any pressure on to the cables themselves,
3. Place the Certimus in the hole so that the orientation to the north matches the pointer on the device as closely as possible,
4. Place the cables so that they’re not coiled and not exerting any pressure on the Certimus ports,
5. Put a sandbag on top of the Certimus (this helps to protect it and provides better coupling to the ground)
6. Backfill the hole with substrate (earth or gravel), then compact the surface to ensure minimal subsidence,

---

### 1.3.4.4 *Installation in Hazardous Environments*

The fully enclosed, aluminium case design of the Certimus makes it suitable for use in hazardous environments where electrical discharges due to the build-up of static charge could lead to the ignition of flammable gasses. To ensure safe operation in these conditions, the metal case of the instrument must be electrically bonded

## Minimus, Minimus+, Fortimus, Certimus

('earthed') to the structure on which it is mounted, forming a path to safely discharge any static charge.

Where electrical bonding ('earthing') is required during the installation of a Certimus, this can be done by using a ring tag on one of the screws mounting the power connector.

Alternatively, the negative connection of the DC in is connected to case internally.

### 1.3.5 Instrument and Channel Names

The tables in this section are designed to inform users of the names and codes of the streamed and recorded channels present in the Certimus. The first character of a miniSEED channel code represents the sample rate. The possible values are shown in the table below:

Code	Sample Rate
<b>F</b>	≥ 1000 Hz to < 5000 Hz
<b>C</b>	≥ 250 Hz to < 1000 Hz
<b>H</b>	≥ 80 Hz to < 250 Hz
<b>B</b>	≥ 10 Hz to < 80 Hz
<b>M</b>	> 1 to < 10
<b>L</b>	≈ 1
<b>V</b>	≈ 0.1 Hz
<b>U</b>	≈ 0.01 Hz
<b>R</b>	≥ 0.0001 Hz to < 0.001



**Note:** Throughout this section, the letter *n* in italic script is used to indicate the Sensor number, which is a small integer used to identify the signal source.

In a Certimus, this is zero ('Sensor0') for the channels related to the digitiser's state of health, clock information and battery status – where applicable. It is one ('Sensor1') for the seismometer's channels, such as velocity output, mass position channels, MEMS accelerometer channels, etc.

#### 1.3.5.1 Sensor0 Channels

Sensor	Comp.	Data streaming			Data recording	
		Digital filter mode	Live stream name	Live Stream code	Data record name	Mini SEED channel code
Input voltage		Acausal	S0Voltage	0VINP0	Voltage_sd	xQV

Minimus, Minimus+, Fortimus, Certimus

Sensor	Comp.	Data streaming			Data recording	
		Digital filter mode	Live stream name	Live Stream code	Data record name	Mini SEED channel code
Power		Acausal	S0Power	0PINP0	Power_sd	xYP
Precision temperature		Acausal	S0TemprA	0TMPA0	S0TemprA	xKO
Internal Clock	Internal clock offset from GNSS	Acausal	ClkGpsOffset	0CGPSO	ClkGpsOffset	xEO
	Internal clock period difference from GNSS	Acausal	ClkGpsPeriod	0CGPSP	ClkGpsPeriod	BEF
	Internal clock DAC frequency pulling	Acausal	ClkDacFreqPull	0CVDAC	ClkDacFreqPull	BED
	Test internal clock drift	Acausal	ClkTestPbpS	0CTSTB	ClkTestPpbS	BEB
	Internal clock offset from PTP	Acausal	ClkPtpOffset	0CPTPO	ClkPtpOffset	BEP
	Delay MS	Acausal	ClkPtpDelayMS	0CPDMS	ClkPtpDelayMS	BEA
	Delay SM	Acausal	ClkPtpDelaySM	0CPDSM	ClkPtpDelaySM	BEB
	Mean path delay	Acausal	ClkPtpMeanPathDelay	0CPMPD	ClkPtpMeanPathDelay	BEC
Battery pack	External battery voltage	Acausal	BattVoltage_	BattVoltage_	BattVoltage_sd	LQV
	External battery current	Acausal	BattCurrent_	BattCurrent_	BattCurrent_sd	LYI
	External battery charge Volts	Acausal	BattChargeV_	BattChargeV_	BattChargeV_sd	AQQ
	External battery charge current	Acausal	BattChargeI_	BattChargeI_	BattChargeI_sd	LYQ
	External battery temperature	Acausal	BattTemp_	BattTemp_	BattTemp_sd	LYT
	External battery charge	Acausal	BattCharge_	BattCharge_	BattCharge_sd	LYC
	External battery power	Acausal	BatteryPower_	BatteryPower_	BatteryPower_sd	LYW

### 1.3.5.2 Broadband Seismometer Channels

The names of recorded seismic and accelerometer channels are suffixed with “A” or “B”. This notation distinguishes between the two different sample rates that is possible to configure for each recorded channel. For example, the recorded streams *SOAccZA* and *SOAccZB* carry digitisations of the same signal, differing only in the sample rate. The below tables show the channels available from a Certimus.

Sensor	Comp.	Digital filter mode	Data streaming		Data recording	
			Live stream name	Live Stream code	Data record name	Mini SEED channel code
Analogue broadband seismometer	Vertical	Acausal	S1SeisZ	1VELZ0	S1SeisZA	xHZ
			S1SeisZ	1VELZ2	S1SeisZB	xHZ
		Causal	S1SeisZLowLat	1VELZC	S1SeisZLowLat	xHZ
	North	Acausal	S1SeisN	1VELN0	S1SeisNA	xHN
			S1SeisN	1VELN2	S1SeisNB	xHN
		Causal	S1SeisNLowLat	1VELNC	S1SeisNLowLat	xHN
	East	Acausal	S1SeisE	1VELE0	S1SeisEA	xHE
			S1SeisE	1VELE2	S1SeisEB	xHE
		Causal	S1SeisELowLat	1VELEC	S1SeisELowLat	xHE
	Calibration channel		Acausal	S1Calib	1VELC0	

### 1.3.5.3 Environmental Channels

Sensor	Comp.	Digital filter mode	Data streaming		Data recording	
			Live stream name	Live Stream code	Data record name	Mini SEED channel code
MEMS accelerometer	Vertical	Acausal	S1AccZ	1AXLZ0	S1AccZA	xNZ
					S1AccZB	xNZ
		Causal	S1AccelZLowLat	1AXLZC		xNZ
	North	Acausal	S1AccN	1AXLN0	S1AccNA	xNN
					S1AccNB	xNN
		Causal	S1AccelNLowLat	1AXLNC		xNN
	East	Acausal	S1AccE	1AXLE0	S1AccEA	xNE
					S1AccEB	xNE
		Causal	S1AccelELowLat	1AXLEC		xNE
	Magnetometer	Vertical	Acausal	S1MagZ	1MAGZ0	S1MagZ
North		Acausal	S1MagN	1MAGN0	S1MagN	xFN

Minimus, Minimus+, Fortimus, Certimus

Sensor	Comp.	Data streaming			Data recording	
		Digital filter mode	Live stream name	Live Stream code	Data record name	Mini SEED channel code
	East	Acausal	S1MagE	1IMAGE0	S1MagE	xFE
Mass position	Vertical	Acausal	S1IntZ	1INTZ0	S1IntZ	xMZ
	North	Acausal	S1IntN	1INTN0	S1IntN	xMN
	East	Acausal	S1IntE	1INTE0	S1IntE	xME
STA/LTA parameters	STA	Acausal	S1STAZ	1LTAZ0	S1STAZ	xZ0
	LTA	Acausal	S1LTAZ	1STAZ0	S1LTAZ	xZ1
	Ratio	Acausal	S1RatioZ	1RatZ0	S1RatioZ	xZ2
Sensor rotation	Yaw	Acausal	S1RotYaw	1ROTY0	S1RotYaw	xYY
	Pitch	Acausal	S1RotPitch	1ROTP0	S1RotPitch	xYP
	Roll	Acausal	S1RotRoll	1ROTR0	S1RotRoll	xYR
Centring	Vertical	Acausal	S1CentringZ	1CENZ0	S1CentringZ	xE5
	North	Acausal	S1CentringN	1CENN0	S1CentringN	xE6
	East	Acausal	S1CentringE	1CENE0	S1CentringE	xE7
Input voltage		Acausal	S1Voltage	1VOLT0	S1Voltage	xE4
Digitiser power usage		Acausal	S1Power	1PINP0	S1Power	xYP
Humidity within sensor enclosure		Acausal	S1HumidB	1HUMB0	S1HumidB	xIO
Pressure within sensor enclosure		Acausal	S1Pres	1PRSR0	S1Pres	xDI
Temperature		Acausal	S1TemprB	1TMPB0	S0TemprB	xKO
Internal Clock DAC frequency pulling		Acausal	S1ClkDacFreqPull	1CVDAC	S1ClkDacFreqPull	BED
PLL clock offset		Acausal	S1PLLOffset	1PLLO0	S1PLLOffset	xYO

## 2 Part 2: Common Information

### 2.1 Unpacking

Inside the box, you will find:

- The purchased item (Minimus, Minimus+, Fortimus or Certimus),
- The accessory package (if purchased) including:
  - An ethernet cable,
  - A compact GNSS receiver,
  - A power cable,
  - A diagnostic GNSS to serial cable adapter,
- The calibration documents in a yellow envelope (see Chapter 2.7.1.5).

#### 2.1.1 The Purchased Item

For more details about the item purchased please read the following chapters:

- [1.1. Minimus and Minimus+](#)
- [1.2. Fortimus](#)
- [1.3. Certimus](#)

#### 2.1.2 Ethernet Cable

The Ethernet connector allows the use of 10BASE-T, 100BASE-T or 1000BASE-T transmission over networks. The metal gland shell-type connector that connects to the device is IP68-rated and ensures consistent connection in harsh installation environments. At the other end of the Ethernet cable, there is a standard 8P8C modular jack (often called an RJ45) for attachment to all common networking devices (including: PC, laptop, router, switch, and modem).

##### 2.1.2.1 Pin-Outs

The image on the right is an Amphenol RJField-series 8P8C connector. It consists of a standard ISO 8877 8P8C modular socket (often called an RJ45) in a bayonet mounting compatible with MIL-DTL-26482 (formerly MIL-C-26482).

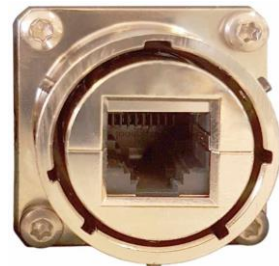

The wiring of a standard ethernet cable is shown below for configuration of different transmission types:

Pin	10BASE-T & 100BASE-TX	1000BASE-T
1	Transmit Data +	BI_DA+
2	Transmit Data -	BI_DA-
3	Receive Data +	BI_DB+
4	<i>not connected</i>	BI_DC+
5	<i>not connected</i>	BI_DC-
6	Receive Data -	BI_DB-
7	<i>not connected</i>	BI_DD+
8	<i>not connected</i>	BI_DD-



The 8P8C connector shown left accepts unmodified ISO 8877 8P8C modular connectors (often called RJ45 connectors or Ethernet "Cat 5/6" connectors).

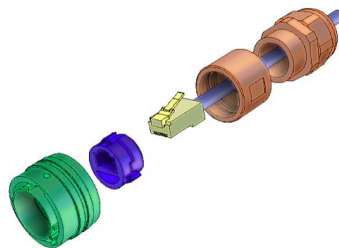

When used in hostile environments, a standard Ethernet cable can have a mating environmental shield (Amphenol part number RJF6MN) fitted.



### 2.1.3 Compact GNSS Receiver and Cable

The new-generation compact GNSS receiver has an in-built antenna that supports the GPS (Navstar), GLONASS, BeiDou and Galileo satellite constellations.



The receiver comes with a black RS-422 cable that has an over-moulded 14-way LEMO connector. LEMO connectors use an innovative latching mechanism which is different to the bayonet connectors used elsewhere. To mate, simply line up the red marks – one on the chassis and one on the free connector – and gently push the connector into place until they latch together with a click. To disconnect (un-mate), grasp the outer sleeve of the connector and pull gently.

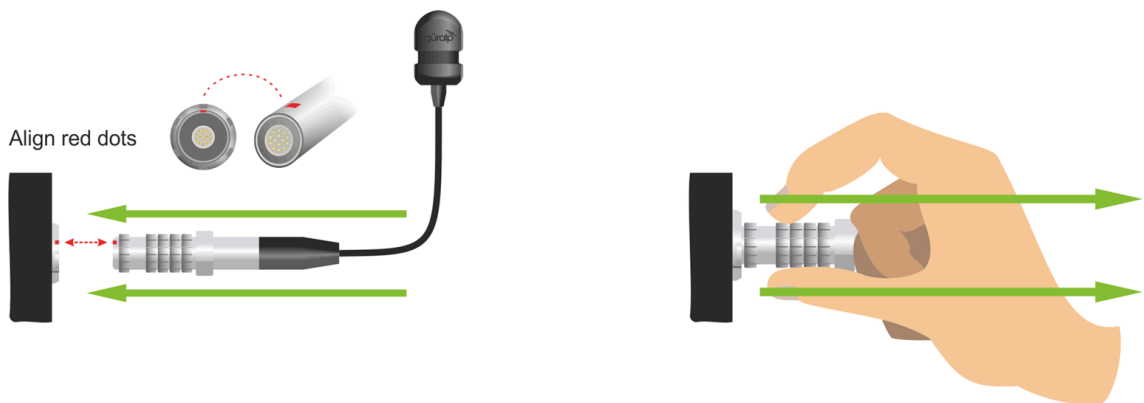

**Caution:** Do not twist the connector or use any tools.



#### 2.1.3.1 Pin-Outs

This is a 14-pin LEMO EEG.1K socket. Suitable mating connectors can be found in the LEMO FGG.1K.314 range.

- To engage the mating connector, line up the red marks and push firmly until you hear a click.
- To disengage, hold the mating connector by the knurled outer sleeve and pull steadily.



Pin	Function
-----	----------

## Minimus, Minimus+, Fortimus, Certimus

1	Ground
2	<i>not connected</i>
3	Ground
4	Debug (serial) receive
5	Debug (serial) transmit
6	<i>not connected</i>
7	GNSS power
8	GNSS pulse-per-second signal – RS-422 positive
9	GNSS receive – RS-422 positive
10	GNSS transmit – RS-422 positive
11	GNSS transmit – RS-422 negative
12	<i>not connected</i>
13	GNSS pulse-per-second signal – RS-422 negative
14	GNSS receive – RS-422 negative

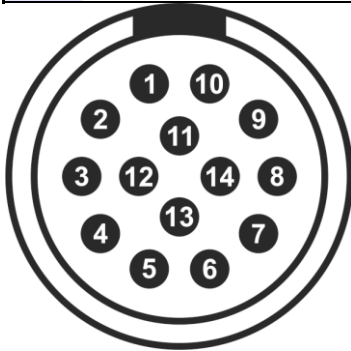

Wiring details for the compatible plug, FGG.1K.314 range, as seen from the cable end (*i.e.* when assembling).

---

### 2.1.4 Power Cable

Every device comes with a dedicated power cable with a standard military-specification bayonet connector on one end and bare ends at the other.

### 2.1.4.1 Pin-Outs

This is a standard 4-pin military-specification bayonet plug, conforming to MIL-DTL-26482 (formerly MIL-C-26482).



Pin	Function
A	Ground
B	10-36 V DC input
C	<i>not connected</i>
D	<i>not connected</i>

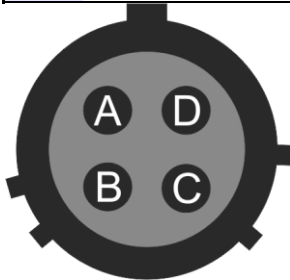

Wiring details for the compatible socket as seen from the cable end (i.e. when assembling).

### 2.1.5 Diagnostic GNSS to Serial Cable Adapter

Every device comes with an adapter to connect the GNSS LEMO connector to a female nine-pin D-sub-miniature connector (DE9f), which can be used with a standard serial port to allow diagnosis and debugging of the instrument using a serial terminal emulator (see [Chapter 22](#)).



**Note:** This facility should rarely be required. It is primarily intended for use by the Güralp Support Team to help diagnose any problems with the device that may be experienced by the user.

A serial-to-USB converter (not supplied) may need to be used to connect to PCs or laptops that don't have a nine-pin serial connector.

### 2.1.5.1 Pin-Outs

This is a 14-pin LEMO EEG.1K socket. Suitable mating connectors can be found in the LEMO FGG.1K.314 range.

- To engage the mating connector, line up the red marks and push firmly until you hear a click.
- To disengage, hold the mating connector by the knurled outer sleeve and pull steadily.



Pin	Function
1	Ground
2	<i>not connected</i>
3	Ground
4	Debug (serial) receive
5	Debug (serial) transmit
6	<i>not connected</i>
7	GNSS power
8	GNSS pulse-per-second signal – RS-422 positive
9	GNSS receive – RS-422 positive
10	GNSS transmit – RS-422 positive
11	GNSS transmit – RS-422 negative
12	<i>not connected</i>
13	GNSS pulse-per-second signal – RS-422 negative
14	GNSS receive – RS-422 negative

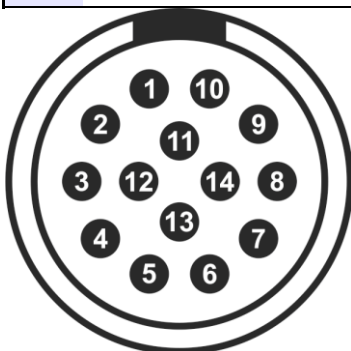

Wiring details for the compatible plug, FGG.1K.314.\*, as seen from the cable end (*i.e.* when assembling).

## 2.2 Getting Started: System Setup and Network Configuration



**Note:** For the sake of brevity, instruments running the DIG firmware (Minimus, Minimus+, Fortimus and Certimus) will be referred to as the *Minimus* throughout this document. Situations where instructions only refer to a specific instrument, or where they do not apply to one or more of them, this will be indicated.

Güralp highly recommends exploring and gaining familiarity with the Minimus inside your lab before installation in an outdoors environment. Please follow the steps in this Chapter in order to start communicating with your instrument.

To get started, connect the power cable to the power connector on the side of your device: this is a 4-pin plug, and the word “POWER” is printed below it. Power up the Minimus using a power supply with a DC output of between 10 and 36 Volts. We recommend fitting an in-line 3.5 A anti-surge fuse in the positive power lead to protect the external wiring of the installation. The Minimus will, in turn, provide power to all connected instruments.



**Caution:** Observe the correct polarity when connecting the power supply. The **red** lead (from pin B) must be connected to the **positive terminal**, typically labelled “+”, and the **black** lead (from pin A) must be connected to the **negative terminal**, typically labelled “-”. An incorrect connection risks destroying the digitiser, the power supply and any connected instruments.

Once the Minimus is powered up, the LED will start blinking following the pattern described in Section 2.11.1. If your device has an LCD screen, this will turn on too.

Now, connect the Ethernet cable to the Minimus and directly into your laptop. Plug the GPS receiver into the 14-pin LEMO socket of the Minimus and, if possible, position the receiver close to a window. This will increase the chances to obtain a GPS lock. Your setup will look like in the figure below:

## Minimus, Minimus+, Fortimus, Certimus



### 2.2.1 I.P. Address Configuration on PC or Laptop

If the Minimus is directly connected to a laptop or PC using the blue Ethernet cable, make sure that the laptop or PC is configured to obtain an I.P. address automatically.

With APIPA (Automatic Private I.P. Addressing), a laptop or PC can automatically configure itself with an I.P. address in the range 169.254.0.1 to 169.254.255.254. The default subnet mask is 255.255.0.0. By default, the Minimus uses DHCP (Dynamic Host Configuration Protocol) to acquire its network configuration. If a DHCP server is not found – as in the case of a Minimus connected directly to a laptop – it will acquire an I.P. address in the range 169.254.0.1, meaning that the laptop and Minimus are in the same subnet.

Static addressing can be used if required, and more detailed will be provided in Section 2.2.4. However, configuring your laptop to obtain its I.P. address automatically and leaving the Minimus in DHCP mode is the easiest way to communicate with your device.

## Minimus, Minimus+, Fortimus, Certimus

To configure the connection using APIPA, power up the Minimus and connect it to the laptop or PC using the blue Ethernet cable, as explained previously.

### 2.2.1.1 On Linux

On your Linux computer, open the terminal and type the command:

```
sudo bash
```

Press the **Enter** key and provide the appropriate password. Then, enter the command:

```
ifconfig
```

to identify the Ethernet network interface to which the Minimus is connected. Once you have identified the correct interface, connect the Minimus, power it up and enter the commands:

```
ifconfig wlp2s0 down
```

```
ifconfig wlp2s0 up
```

replacing `wlp2s0` with the name of the appropriate interface on your PC.

Enter the command `ifconfig` again to verify that the IPv4 address of the Ethernet adapter is now included in the network `169.254.0.0/16` - *i.e.*, the address begins with `169.154...`

```
wlp2s0 flags=4163<UP,BROADCAST,RUNNING,MULTICAST> mtu 1500
inet 169.254.139.29 netmask 255.255.0.0 broadcast 169.254.255.255
ether 94:65:9c:ab:3c:9a txqueuelen 1000 (Ethernet)
RX packets 556837 bytes 722823565 (689.3 MiB)
RX errors 0 dropped 0 overruns 0 frame 0
TX packets 320424 bytes 42811910 (40.8 MiB)
TX errors 0 dropped 0 overruns 0 carrier 0 collisions 0
```

In the example above, the interface has been allocated address `169.254.139.29`, which is in the correct network.

### 2.2.1.2 On Windows

On a Windows computer, key **Windows** + **R** to open the "Run" dialogue, enter `ncpa.cpl` and press the **Enter** key.

Right-click on the network adapter which is connected to the Minimus and select **Disable** from the context menu. Right-click on the same adapter again and select **Enable**. Close the network settings window.

Key **Windows** + **R** and type `cmd`, then **Enter** key. This opens a command prompt. Type the command `ipconfig` and verify that the IPv4 address of the Ethernet adapter is included in network `169.254.*.*`.



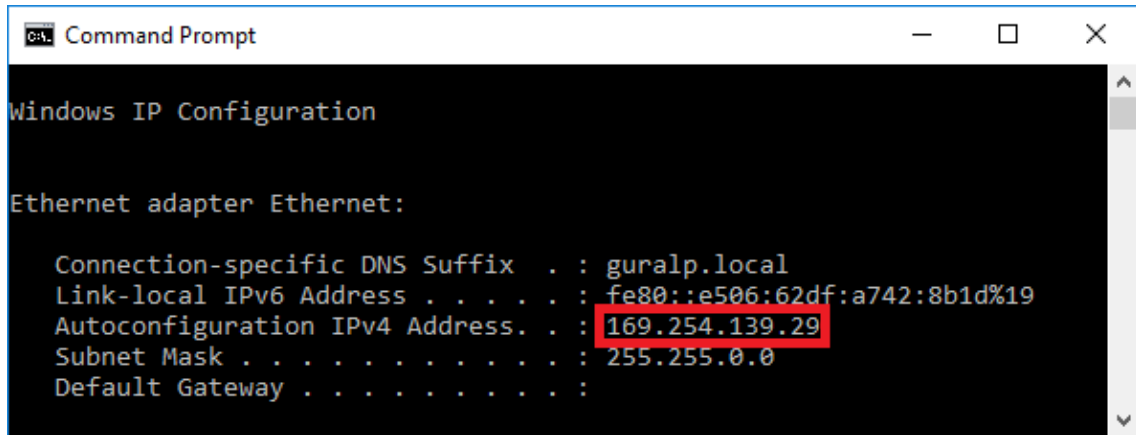

In the example above, the interface has been allocated address 169.254.139.29, which is in the correct network.

## 2.2.2 Your Device's IP address: Discovery

If your device is provided with an LCD display (Certimus and Fortimus), its IP address appears on the Status page of the display.

If your device is not provided with an LCD display (Minimus and Minimus+), finding out its I.P. address is one of the first challenges. Güralp's **Discovery** software makes the process simple by automatically finding and listing devices connected via local networks.

 **Note:** Full user instructions for Discovery are beyond the scope of this document. For full user information, please refer to Discovery's manual [MAN-DIS-0001](#).

If your laptop/PC and Minimus have been configured as detailed in Section 2.2.1 they will be on the same network and the Minimus will automatically appear in Discovery's main window within a few tens of seconds. Discovery's main window will look like the in figure below.

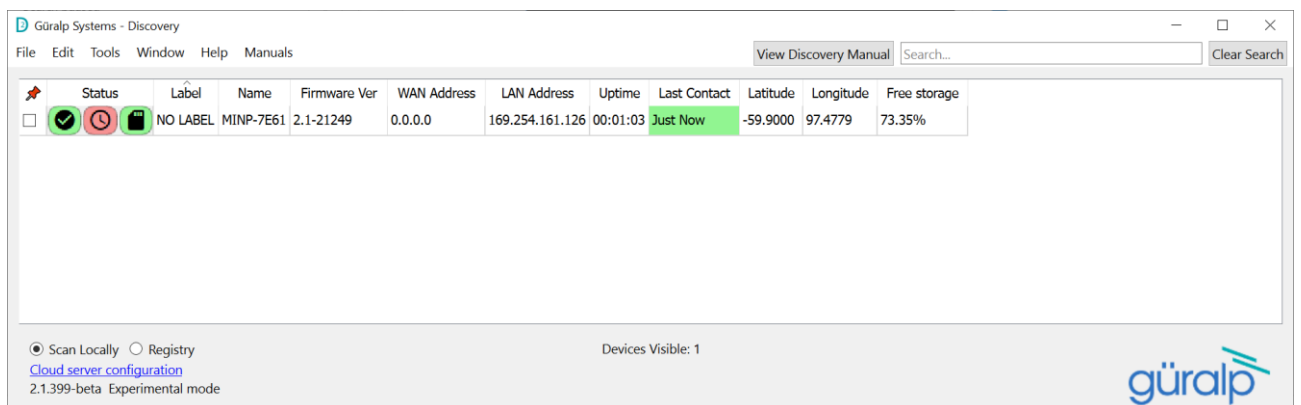

The Minimus I.P. address is listed under the "LAN address". In this case, the I.P. address is 169.254.161.126.

Once the device's I.P. address is known, system configuration and control are available from the webpage interface. This can be accessed:

## Minimus, Minimus+, Fortimus, Certimus

- by selecting an instrument in Discovery, right-clicking its entry and selecting "View Web Page"
- by typing the LAN address of the instrument into any common web browser.

### 2.2.3 Web Page Interface Login

The web page interface can be protected by a username and password. There are two levels of access to the web page interface: user and administrator.

If the login is enabled (by default it is enabled), the web page interface will initially show a status display only.

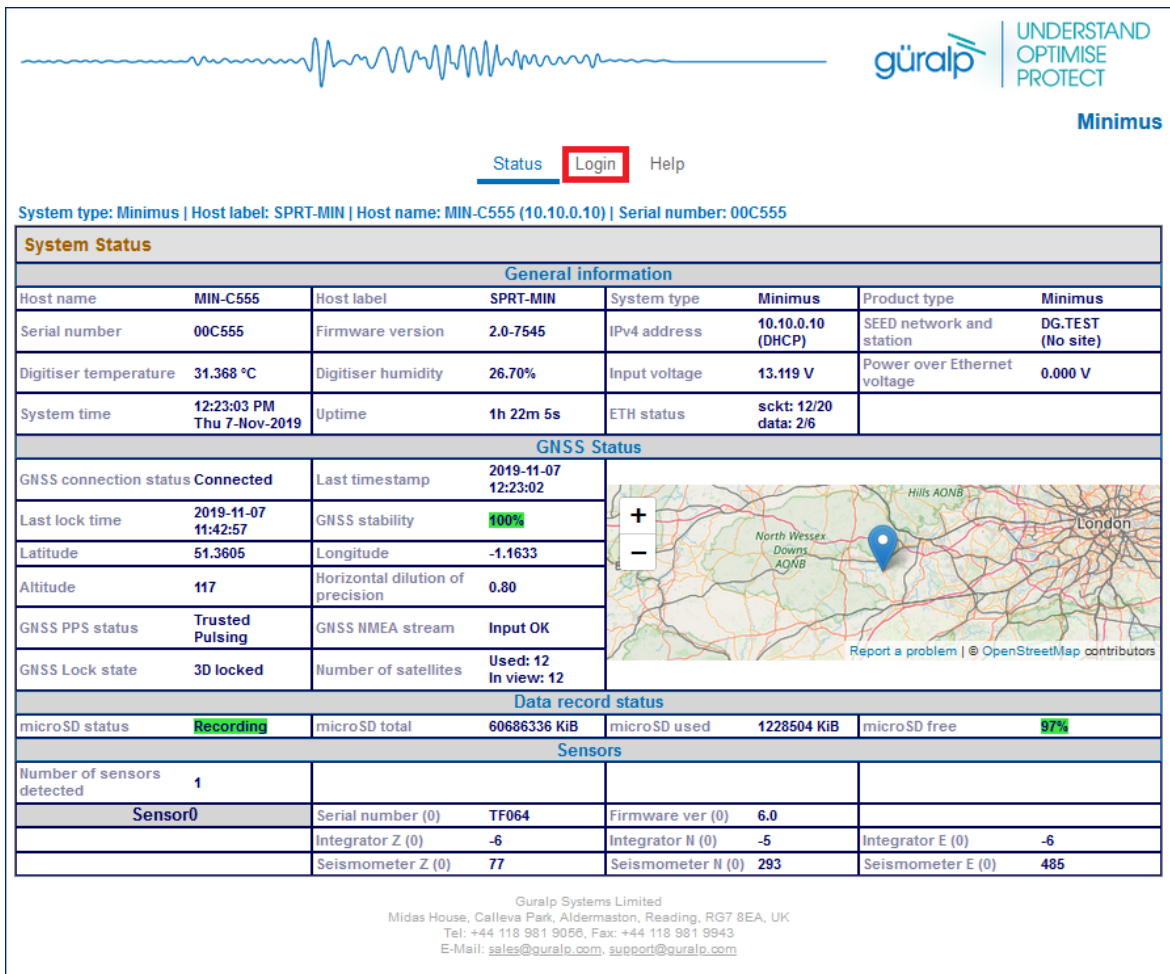

The screenshot shows the Minimus web page interface. At the top right, there is a logo for 'güralp' with the tagline 'UNDERSTAND OPTIMISE PROTECT' and the word 'Minimus' below it. In the center, there are navigation links for 'Status', 'Login' (highlighted with a red box), and 'Help'. Below the navigation links, the system information is displayed: 'System type: Minimus | Host label: SPRT-MIN | Host name: MIN-C555 (10.10.0.10) | Serial number: 00C555'.

The main content area is divided into several sections:

- System Status**: A table with columns for Host name, Host label, System type, Product type, Serial number, Firmware version, IPv4 address, SEED network and station, Digitiser temperature, Digitiser humidity, Input voltage, Power over Ethernet voltage, System time, Uptime, and ETH status.
- GNSS Status**: A table with columns for GNSS connection status, Last timestamp, Last lock time, GNSS stability, Latitude, Longitude, Altitude, Horizontal dilution of precision, GNSS PPS status, GNSS NMEA stream, GNSS Lock state, and Number of satellites. A map is shown on the right side of this section, indicating the location of the instrument.
- Data record status**: A table with columns for microSD status, microSD total, microSD used, and microSD free.
- Sensors**: A table with columns for Number of sensors detected, Sensor0, Serial number (0), Firmware ver (0), Integrator Z (0), Integrator N (0), Integrator E (0), Seismometer Z (0), Seismometer N (0), and Seismometer E (0).

At the bottom of the page, there is contact information for Guralp Systems Limited, including the address, telephone number, fax number, and email addresses.

Clicking on **Login** opens the sign in box and allows you to type in a Username and Password to access the content of the web page interface.



Logging in with a user account unlocks basic configuration and control features to prevent advanced settings from being modified. The default username for a user account is user and the password is also user.

Logging in with the administrator account unlocks all the configuration and control features available on the Minimus web page interface. The default username for the administrator account is admin and password is also admin.



**Note:** For regular use and basic configuration changes, Guralp suggests logging in as `user`. Log in as `admin` only if necessary to unlock features only available in the administrator account.

Once logged in as administrator, the **Web Login** drop-down menu in the **Network** tab makes it possible to disable the request for login every time the web page interface is accessed. The username and password for both user and administrator logins are configurable in the **Network** tab.

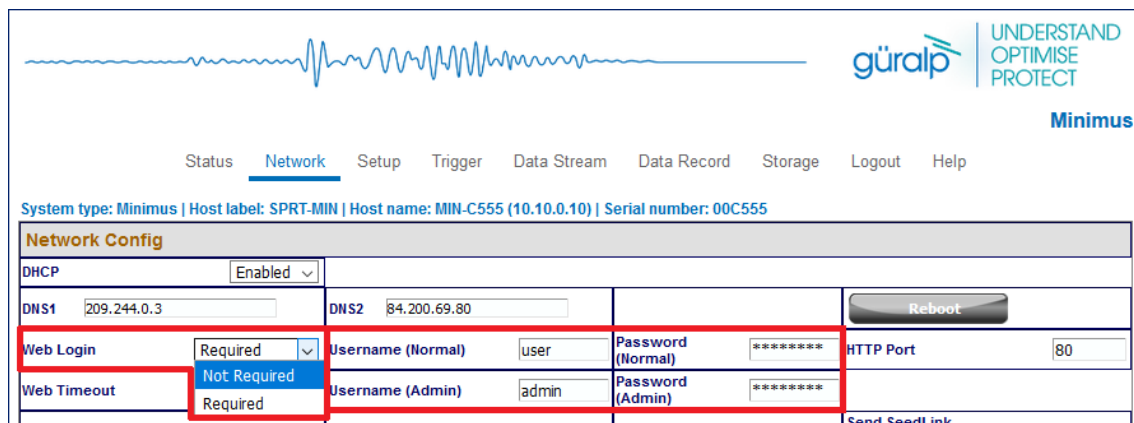

## 2.2.4 I.P. Address Configuration

As previously mentioned, by default the Minimus uses DHCP (Dynamic Host Configuration Protocol) to acquire its network configuration. This is the setting that Guralp recommends using, but static addressing can be used if required.

To configure static addressing, visit the **Network** tab of the instrument's web page interface. Next to the "DHCP" field is a drop-down box that allows you to change the mode from "Enabled" to "Disabled". In this mode, it is possible to specify the I.P. address, the Netmask and the address of the Gateway (default router), as shown:

## Minimus, Minimus+, Fortimus, Certimus

güralp | UNDERSTAND  
OPTIMISE  
PROTECT

Minimus

Status **Network** Setup Trigger Data Stream Data Record Storage Logout Help

System type: Minimus | Host label: SPRT-MIN | Host name: MIN-C555 (10.10.0.10) | Serial number: 00C555

**Network Config**

DHCP	Disabled	Static IP addr	10.10.0.10	Net Mask	255.255.255.0	Gateway	10.10.255.1	
DNS1	209.244.0.3	DNS2	84.200.69.80					Reboot
Web Login	Required	Username (Normal)	user	Password (Normal)	*****	HTTP Port	80	

Before any changes made here will take effect, the Minimus must be rebooted. To do this, click on the **Reboot** button.



**Note:** By default, the static I.P. address assigned to each Minimus is unique and derived from the specific serial number of the device. These addresses are in the default network for link local (APIPA) addresses:  $169.254.0.0/16$  (in CIDR notation).

The first two octets of the address, therefore, are always  $169.254$ . The third octet is the equal to the last two characters of the serial number interpreted as a hexadecimal number and then converted into base 10. The fourth octet is equal to the first two digits after the hyphen of the serial number, also converted from hexadecimal into base 10.

For example, if the serial number of the Minimus MIN-C555, the pre-assigned static I.P. address will be  $169.254.85.197$ , where:

- MIN-C5**55**  $\Rightarrow (5 \times 16^1) + (5 \times 16^0) = 85$
- MIN-C**5**55  $\Rightarrow (12 \times 16^1) + (5 \times 16^0) = 197$

Network settings are also available in Discovery by right-clicking on the Minimus' entry in Discovery's main window and selecting **Edit Network Address**.

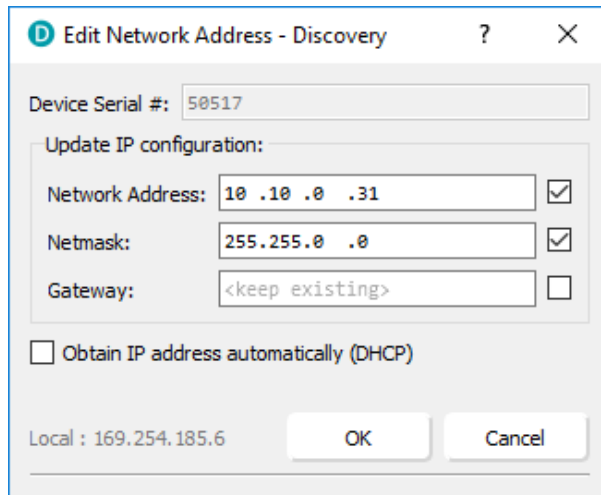

## 2.2.5 System Status

The **Status** tab of the web browser interface provides state-of-health information about the Minimus and connected instruments. These parameters are described as follows:

### General Status

- **Host name:** The model of the device and the serial number;
- **Host label:** The customisable name of the Minimus system: this name can be changed from the **Setup** tab. It reflects how the Minimus appears in the list of instruments in Discovery's main window;
- **System type:** The name of the instrument, *e.g.* "Minimus";
- **Product type:** The type of the instrument, *e.g.* "Minimus";
- **Serial number:** The serial number of the Minimus;
- **Firmware version:** The DIG firmware version running on the Minimus;
- **IPv4 address:** the Static or Dynamic LAN I.P. address of the Minimus;
- **SEED network and station:** Network and Station SEED codes of the Minimus;
- **Digitiser temperature & Digitiser humidity:** The internal temperature and humidity of the Minimus;
- **Input voltage:** The input voltage supplied to the Minimus;
- **PoE (Power over Ethernet) voltage:** Optional PoE voltage supplied to Minimus+, Certimus and Fortimus only (not applicable to Minimus);
- **System time:** The current internal system date and time from the Minimus;
- **Uptime:** The time the Minimus has been running since the last reboot;

- **Restart Status:** Shows the number of Restarts and whether they were caused by Crashes (software reboot) or Power cycles;
- **ETH (Ethernet) status:** The number of total active TCP connection in use or used for data transmission;

#### GNSS Status

- **GNSS (Global Navigation Satellite System) connection status:** Shows whether the GNSS receiver is connected;
- **Last timestamp:** Shows the time when data was last received from GNSS.
- **Last lock time:** Shows when the first stable lock was made to the GNSS, since a significant timing drift or reboot;
- **GNSS stability:** The lock strength of the signal from GNSS;
- **Latitude, Longitude and Altitude:** Of the system, as provided by the GNSS receiver;
- **Horizontal dilution of precision:** The confidence level of precision data, based on satellite coverage, lower values mean better precision;
- **GNSS PPS (Pulses Per Second) status:** Benchmark for time synchronization with other sensors, will show if lock is trusted and the status of the pulses;
- **GNSS NMEA (National Marine Electronics Association) stream:** Shows if the NMEA data format is supported from the GNSS;
- **GNSS Lock state:** Shows as 3D or 2D based on the number of visible satellites, 4 satellites or greater will support 3D, fewer than this will result in 2D;
- **Number of satellites:** currently used and total in view of the receiver;

#### PTP Status (only visible if enabled)

- **PTP (Precision Time Protocol) state:** Shows the status of the PTP connection;
- **Last PTP timestamp:** The last time the PTP server sent data;
- **Last PTP lock time:** Time when first stable PTP lock was made since significant timing drift or re-boot.
- **PTP stability:** The stability of the clock in time accuracy;
- **Master IPv4 address:** The I.P. address of the PTP master server;
- **Master clock class:** Shows the source class of the clock;
- **Master clock accuracy:** How accurate the clock is to "true" time, the lower this value is the more accurate the reading will be;
- **Master time source:** Refers to the primary device or clock that provides the reference time for synchronization across the network;
- **Network path delay:** Shows the path delay measurement between the controller and responder clock;

## Minimus, Minimus+, Fortimus, Certimus

- **Network jitter estimate:** Quality indicator measured in ns, refers to the variability in the time delay of network packets;
- **Network outliers:** Outliers typically refer to data points or measurements that significantly deviate from the expected or average values, these are calculated into a percentage value to give an impression of network integrity..

### Data Record Status

- **micro SD status:** Shows if the primary card is recording;
- **micro SD total:** Shows the total storage capacity in KiB;
- **micro SD used:** Shows the current size of the data stored in KiB;
- **micro SD free:** Shows the percentage of space available on the card.

### Sensors Status

- **Number of sensors detected:** Refers to the onboard sensors, this should show 1 for the Minimus, Fortimus and Certimus and 2 for the Minimus+;
  - **Sensor0/I:** Shows the current output values from the onboard sensors.
- 

## 2.2.6 Configurable Station Metadata

Discovery provides a number of flexible station meta-data inputs. These are accessible from the **Setup** tab of the instrument's web page, in the "Digitiser Config" section.

**Host Label** and **Site Name** are only used in Discovery and appear in the list of instruments in the main window.

**Station Code** and **Network Code** are all standard metadata header values used by the miniSEED file format, which will be used as identifiers in locally-stored miniSEED files (see [Section 8.9.1](#)).



## 2.3 Data Storage

### 2.3.1 Data Record Tab

The main panel of the **Data Record** tab from the web interface is shown here:

Channel sampling rate	Data transform	SEED name - please use check-box to modify the default	RESPonse file - if available
<b>Seismic channels</b>			
S0SeisXA	200 Hz	Transforms Disabled for this tap	<input type="checkbox"/> DG.TEST,00 .HDF <a href="#">RESP_file_6</a>
S0SeisZA	200 Hz	Transforms Disabled for this tap	<input type="checkbox"/> DG.TEST,00 .HHZ <a href="#">RESP_file_9</a>
S0SeisNA	200 Hz	Transforms Disabled for this tap	<input type="checkbox"/> DG.TEST,00 .HHN <a href="#">RESP_file_13</a>
S0SeisEA	200 Hz	Transforms Disabled for this tap	<input type="checkbox"/> DG.TEST,00 .HHE <a href="#">RESP_file_17</a>
S0SeisZB	Disabled	Tap Disabled	<input type="checkbox"/> DG.TEST,00 .AHZ <a href="#">RESP_file_10</a>
S0SeisNB	Disabled	Tap Disabled	<input type="checkbox"/> DG.TEST,00 .AHN <a href="#">RESP_file_14</a>
S0SeisEB	Disabled	Tap Disabled	<input type="checkbox"/> DG.TEST,00 .AHE <a href="#">RESP_file_18</a>
<b>Mass position channels</b>			
S0IntZ	100 Hz	Transforms Disabled for this tap	<input type="checkbox"/> DG.TEST,00 .HMZ
S0IntN	100 Hz	Transforms Disabled for this tap	<input type="checkbox"/> DG.TEST,00 .HMN
S0IntE	100 Hz	Transforms Disabled for this tap	<input type="checkbox"/> DG.TEST,00 .HME
<b>MEMS accelerometer channels</b>			

This page allows the user to configure the recording channels for each of the connected instruments and the sensors internal to the Minimus.

**Note:** When changing a setting in the Minimus web page, ensure that you wait until the page refreshes before changing another setting. This allows time for the previous change to take effect.

Under the “Data Record” header, look to the third row down for **Display Streams**, the drop-down box filters out the visible channels below with the following categories: All, Enabled Only and Disabled Only.

The next option to the right **Apply configuration for tap groups** has a checkbox that allows you to automatically apply the same configuration to three streams that belong to the same tap, *e.g.* S0SeisZA, S0SeisNA, S0SeisEA.

The last setting on this row **Display On Page** allows you to view the different instruments connected to this device, *e.g.* Sensor 1.

The next section titled Channels Configuration is divided into four columns:

- The left-most column “Channel sampling rate” contains a drop-down box for each available channel to either select a sample rate or to exclude the channel from streaming by selecting the “Disabled” option. All streaming can be stopped by clicking the **Display All Streams** button. The same configuration can be applied to real-time transmission channels by clicking the **Copy to Data Record** button. The default channel configuration can be applied by clicking the **Restore default** button;
- In the second column “Data transform” there are drop-down boxes for each channel to enable/disable transforms. Once “Enable transform” is selected, the drop-down box will refresh allowing you to select the transform to apply.
- In the third column “SEED name”, Location and Channel SEED codes can be configured. Cells contain default values and are unable to be edited unless the preceding checkbox is clicked.
- In the fourth column “RESPonse file”, there are links to the RESP files associated with each of the sensor channels (see Section 2.10.2 for more details).

Upon changing the sample rate, enabling a transform, or changing the Location or Channel codes, the Minimus will need to be rebooted for the changes to come into effect; this can be done by pressing the **Reboot** button.

During the reboot, the LEDs on the Minimus will flash, displaying the starting-up sequence (see Section 2.11.1) and the instrument’s web page interface will display the following screen.

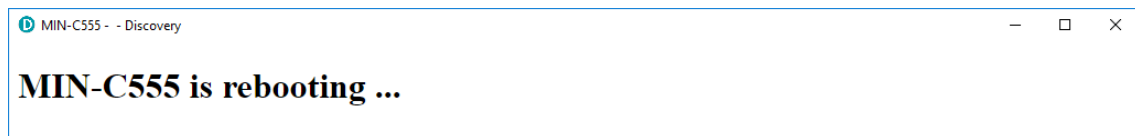

Once the Minimus has successfully restarted, the full web browser display and controls will be available for use again.

---

### 2.3.2 Recording Status

MicroSD cards need to be specifically formatted to operate with the Minimus. The cards shipped with the Minimus are supplied pre-formatted.

Data is stored on the microSD cards in miniSEED format. Each channel is saved as a series of 128 MiB files. Instrument and station metadata (*e.g.* instrument response, coordinates, compression type etc.) are stored in "Dataless SEED" format (see Section 2.10.1 for more details).

The MicroSD card and data recording status can be monitored from the “SD Card control” & the “SD Cards Status” sections of the **Storage** tab.

The “SD Cards Status” section has two columns, the left-hand column provides details of the external (primary, removable) microSD card and the right-hand column shows the status of the internal (backup, fixed) card.

SD Cards status			
External microSD card present	PRESENT	Number of 128-MiB miniSEED files	461
External microSD card usable	USABLE	Internal microSD card usable	USABLE
External microSD card init count	1	Internal microSD card init count	1
External microSD card is primary microSD card	PRIMARY	Internal microSD card is primary microSD card	BACKUP
Primary microSD card is recording samples	RECORDING	Backup microSD card is recording samples	RECORDING

Fields of this panel indicate the state of the following:

- External micro SD card present: Whether a card is inserted into the external slot;
- External/Internal micro SD card Usable: Whether the card has been formatted correctly;
- Primary/Backup microSD card is recording samples: Shows if data is being recorded to the card;



**Note:** If the recording status of the cards is marked **NOT RECORDING**, clicking on **Quickformat Cards** or **Fullformat Cards** may solve the issue. Note that the quick format simply moves the write-pointer to the beginning of the recording space, hence overwriting any existing data. The full format, in contrast, erases all the existing data (and can take several hours).

### 2.3.3 MicroSD Card Re-Formatting

The card re-formatting process fills the card with 128 MiB files containing zeros. Each file is given a temporary, place-holder name. When data is written, these files are renamed and then over-written with the new data.

There are two methods for card reformatting: “Quick format” and “Full format”. The quick format mode should be used for pre-deployment tests (*e.g.* stomp/huddle tests) to ensure that the instruments are operating properly. This mode simply marks the existing files as empty without deleting their contents. Full formatting should be used prior to a long-term deployment to ensure that all headers are included and files are fully clean before writing.

The formatting process formats both fixed and removable cards, sequentially.



**Note:** A series of tests separated only by quick formats can leave some files with residual data in them. This is not normally a problem because a deployment will typically create data-sets longer than any test, over-writing any data remaining from the tests. The “miniSEED extractor” utility (see Section 2.3.10) can be used to remove the residual data if they cause any problems.

#### 2.3.3.1 Quick Format

Ensure that the external microSD card is correctly inserted. Click the **Quickformat Cards** button in the “Storage” tab: a dialogue box will appear to confirm the formatting operation – click on **OK** button to continue.

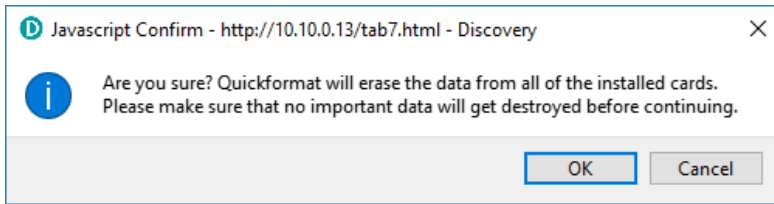

The instrument web page will refresh and return to the **Status** tab. The reformatting operation is now complete.

### 2.3.3.2 Full Format

Ensure the external microSD card is correctly inserted. Click the **Fullformat Cards** button in the **Storage** tab and a dialogue box will appear to confirm the formatting operation – click on the **OK** button to continue.

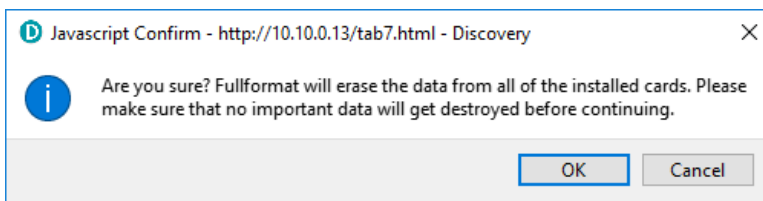

The process takes several hours: check the status countdown indicators on the top-right of **Storage** tab.

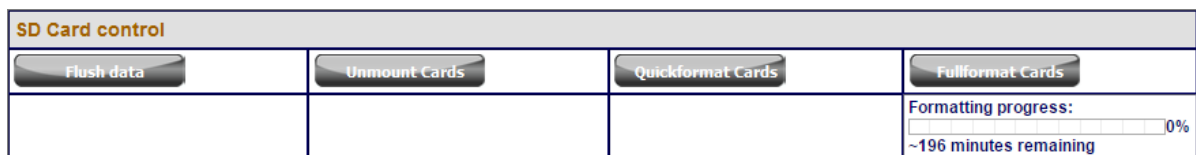

**Caution:** Do not remove or insert the external microSD card while formatting is taking place.

### 2.3.4 MicroSD Card Data Flushing and Unmounting

The **Flush data** button flushes data from the buffer into the microSD card storage. Perform a flushing before downloading data from the **Storage** tab or Seismic Event Table (see Section 2.9.4).

The **Unmount Cards** button flushes the data from the buffers into the microSD cards and interrupts the recording.



**Caution:** After unmounting the SD cards, the recording only restarts if a new card is inserted in the slot *and* the instrument is rebooted, or if a quick-format (or full-format) is performed.

## 2.3.5 Bulk Data Download via Webpage

The **Storage** tab of the web interface displays the miniSEED files stored on the microSD card:

The screenshot shows the Minimus web interface. At the top right, there is a logo for 'güralp' and the text 'UNDERSTAND OPTIMISE PROTECT'. Below the logo is the name 'Minimus'. A navigation menu includes 'Status', 'Network', 'Setup', 'Trigger', 'Data Stream', 'Data Record', 'Storage' (highlighted), 'Logout', and 'Help'. Below the menu, system information is displayed: 'System type: Minimus | Host label: SPRT-MIN | Host name: MIN-C555 (10.10.0.10) | Serial number: 00C555'. The 'SD Card control' section contains buttons for 'Flush data', 'Unmount Cards', 'Quickformat Cards', and 'Fullformat Cards', with a 'Formatting status: idle' indicator. The 'SD Cards status' section is a table with the following data:

External microSD card present	PRESENT	Number of 128-MiB miniSEED files	463
External microSD card usable	USABLE	Internal microSD card usable	USABLE
External microSD card init count	1	Internal microSD card init count	1
External microSD card is primary microSD card	PRIMARY	Internal microSD card is primary microSD card	BACKUP
Primary microSD card is recording samples	RECORDING	Backup microSD card is recording samples	RECORDING

The 'Channel data download by time selection' section has a form with 'Channel: DG.TEST.00.HDF', 'From: dd/mm/yyyy', 'To: dd/mm/yyyy', and a 'Download' button. The 'SD Card files' section is a table with columns for 'Filename', 'Size (bytes)', and 'Last data timestamp'. Below this table is a 'Download selected files' button. The 'Auxiliary files' section is a table with columns for 'Filename' and 'Description'.

Filename	Description
DC.dataless	Dataless SEED file
fram.log	FRAM log file
calvals.txt	SCREAM! calibration values
polezero.txt	SCREAM! zeros, poles and gains
calib.txt	Calibration text file

Single or multiple files can be downloaded simultaneously by ticking the check-boxes on the left of each link and clicking on **Download selected files** button.

The microSD cards are formatted with empty files, which are filled with data as they become available. The filenames are also changed when the files are written on. Before they are written on, they are marked as "hidden" files, so that it is easier to see how many files contain data when looking at the contents of the card.

## 2.3.6 Time-Based Data Download via Webpage

From the **Storage** tab of the web interface, data for a single stream spanning a specific time-interval can be downloaded. To do this, start by selecting the desired stream from the drop-down menu:

Channel data download by time selection

Channel: DG.TEST.00.HDF From: dd / mm / yyyy -- : -- To: dd / mm / yyyy -- : -- Download

SD Card files

Filename	Size (bytes)	Last data timestamp
DG.TEST.00.HDF		
DG.TEST.00.HHZ		
00C555_S0AccEA	76812288	2019-11-07 16:53:08.470000000
00C555_S0SeisEA	102875136	2019-11-07 16:52:23.195000000
00C555_S0SeisNA	102842368	2019-11-07 16:51:18.075000000
00C555_S0SeisZA	115867648	2019-11-07 16:51:30.735000000
00C555_S0SeisXA	95268864	2019-11-07 16:51:50.500000000
00C555_S0AccNA	68534272	2019-11-07 16:50:45.090000000
00C555_S0AccZA	77799424	2019-11-07 16:51:14.460000000
00C555_S0IntE	47296512	2019-11-07 16:49:50.320000000
00C555_S0IntN	47255552	2019-11-07 16:49:50.320000000
00C555_S0IntZ	47235072	2019-11-07 16:49:50.320000000
00C555_S0HumidA	4960256	2019-11-07 16:45:55.700000000
00C555_S0Voltage	8941568	2019-11-07 16:47:53.500000000

Next select the start and end dates using the pop-up calendar, then the desired time range in 24 hour format :

Channel data download by time selection

Channel: DG.TEST.00.HDF From: dd / mm / yyyy -- : -- To: dd / mm / yyyy -- : -- Download

SD Card files

Filename	Last data timestamp
00C555_S0AccEA_00100_00000.mseed	2019-11-07 16:53:08.470000000
00C555_S0SeisEA_00200_00001.mseed	2019-11-07 16:52:23.195000000
00C555_S0SeisNA_00200_00002.mseed	2019-11-07 16:51:18.075000000
00C555_S0SeisZA_00200_00003.mseed	2019-11-07 16:51:30.735000000
00C555_S0SeisXA_00200_00004.mseed	2019-11-07 16:51:50.500000000
00C555_S0AccNA_00100_00005.mseed	2019-11-07 16:50:45.090000000
00C555_S0AccZA_00100_00006.mseed	2019-11-07 16:51:14.460000000
00C555_S0IntE_00100_00007.mseed	2019-11-07 16:49:50.320000000
00C555_S0IntN_00100_00008.mseed	2019-11-07 16:49:50.320000000

Lastly, click the **Download** button to initiate a file transfer to your local device.

## 2.3.7 Bulk Data Extraction via Network

Files stored on the SD card can be downloaded using HTTP. The example bash script below can be used from a Linux PC or from the WSL shell on a Windows PC. The script extracts all files from the SD Card into a directory named after the date and the network address of the Minimus.

```
#!/bin/bash
# Invoke with one argument: the network
# address of the Minimus

set -x
```

## Minimus, Minimus+, Fortimus, Certimus

```
if [ "$#" -ne 1 ] ; then
    echo "Usage: $(basename $0) network_address"
    exit 1
fi

NET_ADDRESS=$1
DATE=$(date --iso-8601)
SAVEDIR = ${DATE}_${NET_ADDRESS}
echo Saving to $SAVEDIR

mkdir $SAVEDIR
cd $SAVEDIR
wget -rnp http://$NET_ADDRESS/tab9.html
cd ..

echo Done
```

### 2.3.8 Time Based Data Extraction via Network

The example Python script below will extract seismic data from the SD card based on a specified time interval. This is similar to the FDSN (International Federation of Digital Seismograph Networks) data archive retrieval service:

<https://www.fdsn.org/webservices/fdsnws-dataselect-1.1.pdf>.

Channel names are as given on the "Data Record" tab of the web interface and the times are specified in UTC time format. The resulting file will be in miniSEED format.



**Note:** The script forms an http request to the instrument in the form of:  
`http://<<IP Address>>/data?channel=<<Channel>>&from=<<Unix Epoch Seconds>>&to=<<Unix Epoch Seconds>>`, which for the example below, would appear as:  
`http://192.168.254.101/data?channel=DG.TEST.01.CHZ&from=1740114000.0&to=1740117600.0`

```
import os
import wget
from obspy import read, read_inventory, UTCDateTime
from obspy.signal import PPSD

##### Start of variable to set #####
sensor = "192.168.254.101"
channel = "DG.TEST.01.CNZ"
start = UTCDateTime("2025-02-21T05:00:00.0")
end = UTCDateTime("2025-02-21T06:00:00.0")
##### End of variables to set #####

startUNIX = UTCDateTime(start).timestamp
#We use the 'start'&'end' to cut the data using Obspy
endUNIX = UTCDateTime(end).timestamp
# We use the 'startUNIX'&'endUNIX' to pull the
# data from the Minimus

#if os.path.exists(r"{0}\tt.mseed".format(temp)):
# See if temp file exists, if so delete.
#os.remove(r"{0}\tt.mseed".format(temp))
```



## Minimus, Minimus+, Fortimus, Certimus

```
if os.path.exists(r"{0}_{1}_{2}.mseed".format(sensor, channel,
start)):
    os.remove(r"{0}_{1}_{2}.mseed".format(sensor, channel,
start))

print(start)

print(r"http://{0}/data?channel={1}&from={2}&to={3}".format(sensor,
channel, startUNIX, endUNIX))
wget.download(r"http://{0}/data?channel={1}&from={2}&to={3}".form
at(sensor, channel, startUNIX, endUNIX),
r"{0}_{1}.mseed".format(channel, startUNIX))
```

The following example in Bash allows you to extract from the SD card the three seismic components of a sensor for a given date over a specified time frame. It then combines the three components into an individual miniSEED file, whose name will include the network code, station code, start date and start time:

```
#!/bin/bash
# Invoke with one argument: the IP address. For example
./script_name 192.168.254.101

set -x

# enter your network details
net_code=DG
station_code=04D67
location_code=0L

#enter the sensor codes for the location targeted, found on the
Data Stream tab of discovery, the last 3 characters/values of the
SEED name (HNZ)
sensor_code1=HNZ
sensor_code2=HNN
sensor_code3=HNE

# choose the day
day=2024-04-28

# choose the start time in 24-hour format (e.g. 16 = 4pm)
start_hour=16

# choose the number of hours to include in the miniSEED file(e.g.
1 = 1-hour-long miniSEED)
step=1

utc=$(date --date ${day} +%s)
start_utc=$(expr $utc + 3600 \* ${start_hour})
end_utc=$(expr ${start_utc} + 3600 \* ${step})

echo $utc
echo $start_utc
echo $end_utc
```

## Minimus, Minimus+, Fortimus, Certimus

```
wget -v -Oz_component.mseed
http://$1/data?channel=${net_code}.${station_code}.${location_code}.${sensor_code1}\&from=${start_utc}\&to=${end_utc}
wget -v -On_component.mseed
http://$1/data?channel=${net_code}.${station_code}.${location_code}.${sensor_code2}\&from=${start_utc}\&to=${end_utc}
wget -v -Oe_component.mseed
http://$1/data?channel=${net_code}.${station_code}.${location_code}.${sensor_code3}\&from=${start_utc}\&to=${end_utc}

# Convert from Unix timestamp to date and time
date_string=`date -d @${start_utc} +%Y.%m.%d-%H.%M.%S`\`

# In this example, the 3-components miniSEED file will be named
"DG.04D67-2024.04.28-16.00.00.mseed"
cat z_component.mseed n_component.mseed e_component.mseed >
${net_code}.${station_code}-${date_string}.mseed
```

---

### 2.3.9 Bulk Data Extraction from MicroSD card

To view files saved on the external microSD card, remove the card. Insert the card into a microSD card reader (external or in-built) on your PC/laptop. Within a few seconds, the card should appear as a removable disc drive.

A microSD card formatted for the Minimus contains many "hidden" files. They are created at format time with no contents and then renamed, unhidden and filled with data as required.

When viewing files in Windows Explorer, it may be helpful to configure your system so that "hidden" files are not shown. In Windows 10, this can be done by checking the "Hidden items" checkbox within the "View" ribbon of Windows Explorer.

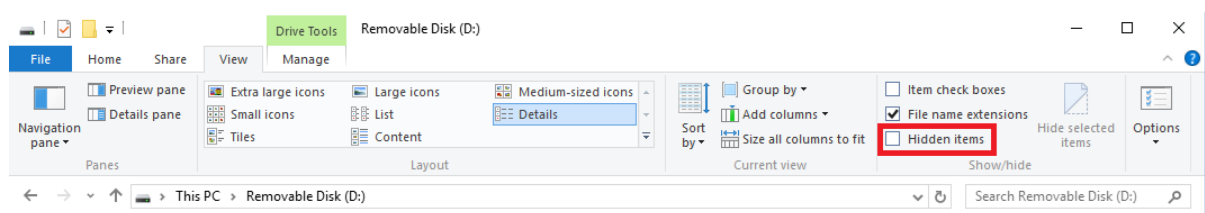

---

#### 2.3.9.1 The Contents of the MicroSD Card

The root directory of the disc contains seven items:

- A file named `init.log`. This file contains the first 32 MiB of system log information since the card was last formatted;
- A file named `system.log`. This file contains the last 64 MiB of the system logs;
- A file named `status.log`. This file contains the last 32 MiB of system state of health information, which is updated every 20 minutes;

## Minimus, Minimus+, Fortimus, Certimus

- A disc image file which Güralp technical support may ask you to use if you have problems with the card;
- A file named `table_of_events.bin`. This is a binary file that is used by the Seismic Events Table in the “Trigger” tab;
- A file with `.dataless` format. This contains meta data to be used in conjunction with the miniSEED files;
- A directory named `all_miniSEED_files_are_in_here`. Within this directory, there will be a miniSEED file for each recording channel. The file-name prefix is the same as the channel name description given in the “Data Record” tab. Each file is 128 MiB in size.

## Minimus, Minimus+, Fortimus, Certimus

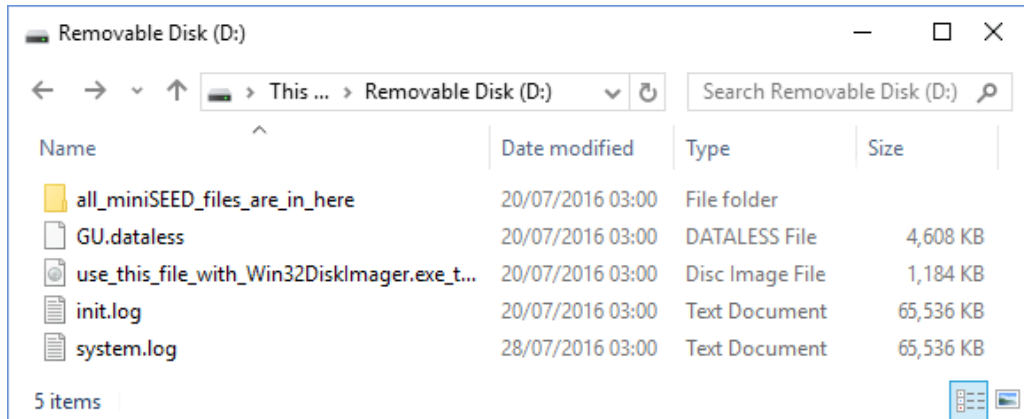

The typical contents of the `all_miniSEED_files_are_in_here` directory looks like this:

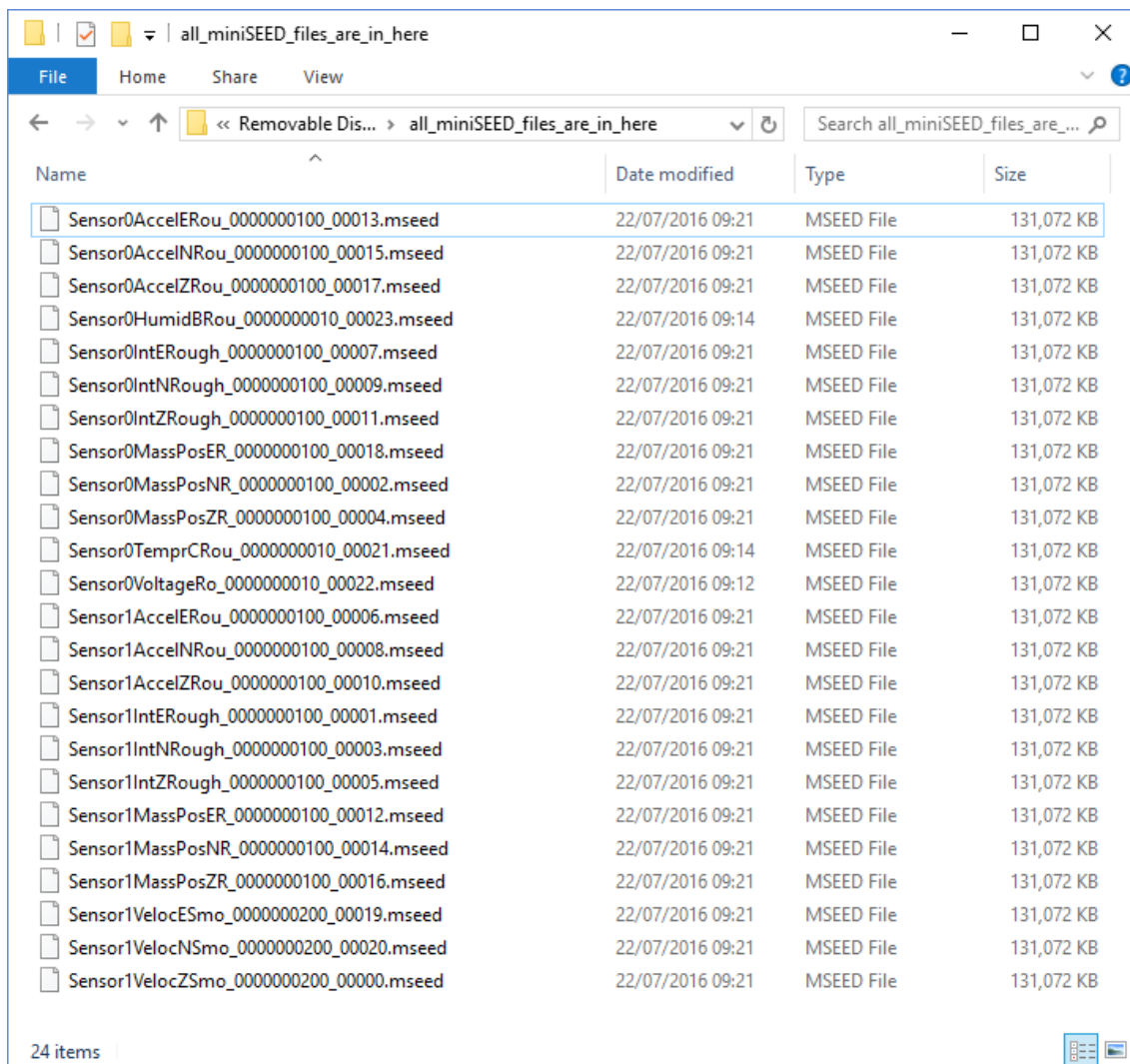

The filename consists of four components:

- The stream name, truncated to 16 characters - see Section 0 (Appendix 1) for a full list of these;

## Minimus, Minimus+, Fortimus, Certimus

- The sample rate (in samples per second) as a ten-digit decimal number, left-padded with zeros;
- A number which functions as a counter to ensure unique filenames for all files. Each time a file is created, this number is incremented so that the next file to be created will use the next value; and
- The `.mseed` extension which identifies this as a miniSEED file.

The "Storage" tab also shows links to five auxiliary files, which are either saved in the Minimus' flash RAM or are dynamically generated:

- `<<SEEDnetwork>>.DATALESS` : This is a dataless SEED volume that contains metadata including instrument responses, coordinates, compression type and more. It is generated from the RESP files for each channel. The first component of the file name depends on the two-character Network code defined in the "Setup" tab. If, for example, this is GU, the file is called `GU.DATALESS`.
- `fram.log` : this is the FRAM log file. It is stored in FRAM.
- `calvals.txt` : this file contains calibration information in a format compatible with the Scream! software package. It is dynamically generated.
- `calib.txt` : this file contains calibration information with poles, zeros etc expressed in hexadecimal notation. It is stored in FRAM.
- `polezero.txt` : this file contains definitions of frequency responses in a format compatible with the Scream! software application. It is dynamically generated.

Auxiliary files	
Filename	Description
<code>DG.dataless</code>	Dataless SEED file
<code>fram.log</code>	FRAM log file
<code>calvals.txt</code>	SCREAM! calibration values
<code>polezero.txt</code>	SCREAM! zeros, poles and gains
<code>calib.txt</code>	Calibration text file

### 2.3.10 MiniSEED Extractor

The miniSEED extractor is a tool available from Discovery and solves two problems:

- When an SD card is quick formatted, each file is marked as unused but previously recorded data can remain within them. Subsequent recordings overwrite these files from the beginning but, if the previous recording had a longer duration, old data would remain in the files. When the files are copied from the SD card to a local device, the left over data can cause problems.
- The format used on the SD cards consists of fixed-length, 128 MiB files. Some recordings might not use all this space. When the files are copied from the SD card to a local device, the formatting can cause wasted disc space.

## Minimus, Minimus+, Fortimus, Certimus

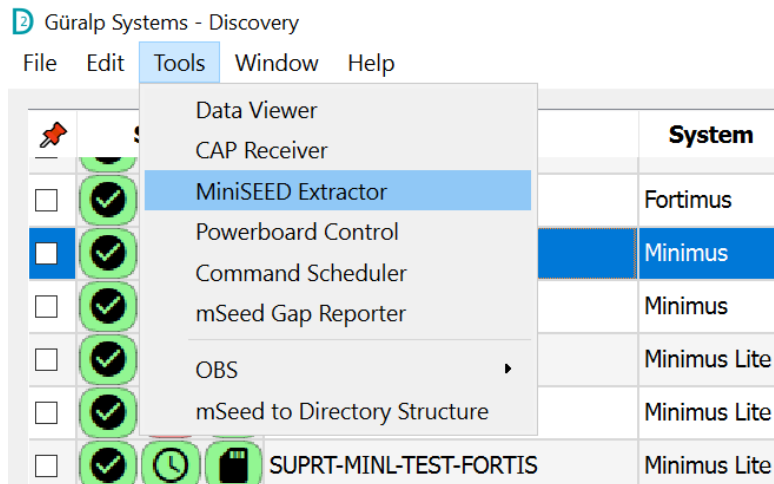

The miniSEED extractor reads miniSEED files on your PC and copies them to a selected destination folder, keeping track of the latest block timestamp as it goes. If it encounters either an unused block or a timestamp which is earlier than the previous one, it stops copying, truncating the output file at that point. This guarantees that each output file contains only blocks in time order and contains no wasted space.

To use the tool, select “miniSEED Extractor” from the “Tools” menu. Click the Top  button to select which files you wish to process and then the Bottom  button to select the folder into which you wish the output files to be written. Finally, click the  button to extract the valid data from the selected files into new files in the selected destination folder.

## 2.4 Data Transmission

### 2.4.1 Data Stream Tab

The monitoring and configuration of transmitted data is handled using the **Data Stream** tab of the instrument's web page.

Channel sampling rate	Data transform	SEED name - please use check-box to modify the default	RESPonse file - if available
<b>Seismic channels</b>			
0AUXX0	200 Hz	Transforms Disabled for this tap	<input type="checkbox"/> DG.TEST,00 ,HDF <a href="#">RESP_file_5</a>
0VELZ0	200 Hz	Transforms Disabled for this tap	<input type="checkbox"/> DG.TEST,00 ,HHZ <a href="#">RESP_file_7</a>
0VELN0	200 Hz	Transforms Disabled for this tap	<input type="checkbox"/> DG.TEST,00 ,HHN <a href="#">RESP_file_11</a>
0VELE0	200 Hz	Transforms Disabled for this tap	<input type="checkbox"/> DG.TEST,00 ,HHE <a href="#">RESP_file_15</a>
0VELZ2	5 Hz	Transforms Disabled for this tap	<input type="checkbox"/> DG.TEST,00 ,MHZ <a href="#">RESP_file_8</a>
0VELN2	5 Hz	Transforms Disabled for this tap	<input type="checkbox"/> DG.TEST,00 ,MHN <a href="#">RESP_file_12</a>
0VELE2	5 Hz	Transforms Disabled for this tap	<input type="checkbox"/> DG.TEST,00 ,MHE <a href="#">RESP_file_16</a>
<b>Mass position channels</b>			
0VELM8	100 Hz	Transforms Disabled for this tap	<input type="checkbox"/> DG.TEST,00 ,HMZ
0VELM9	100 Hz	Transforms Disabled for this tap	<input type="checkbox"/> DG.TEST,00 ,HMN
0VELMA	100 Hz	Transforms Disabled for this tap	<input type="checkbox"/> DG.TEST,00 ,HME
<b>MEMS accelerometer channels</b>			
0AXL10	100 Hz	Transforms Disabled for this tap	<input type="checkbox"/> DG.TEST,99 ,HN1 <a href="#">RESP_file_31</a>
0AXL20	100 Hz	Transforms Disabled for this tap	<input type="checkbox"/> DG.TEST,99 ,HN2 <a href="#">RESP_file_35</a>
0AXL30	100 Hz	Transforms Disabled for this tap	<input type="checkbox"/> DG.TEST,99 ,HN3 <a href="#">RESP_file_39</a>

On this page it is possible to configure the transmitted channels for each of the connected instruments and sensors internal to the Minimus.

The names and contents of each channel are described in Section 0 (Appendix 1).

**Note:** When changing a setting in the Minimus web page, ensure that you wait until the page refreshes before changing another setting. This allows time for the previous change to take effect.

The drop-down box named **Display Streams** found within the Data Stream section of the page filters out visible channels with options for All, Enabled Only and Disabled Only.



## Minimus, Minimus+, Fortimus, Certimus

The option **Apply configuration for tap groups** automatically applies the same configuration to the three streams that belong to the same tap (*e.g.* OVELZ0, OVELN0, OVELE0).

The drop-down box named **Display On Page** within the Data Stream section, allows you to view the sensors from different instruments connected to the Minimus, *e.g.* Sensor 1.

The Channel configuration section is divided into four columns:

- In the first column “Channel sampling rate”, drop-down boxes are available for each channel to either select a sample rate or to exclude the channel from streaming (by selecting the “Disabled” option);
- in second column “Data transform”, drop-down boxes are available for each channel to enable/disable transforms. Once a transform is enabled, the drop-down box will refresh allowing you to select the transform you want to apply;
- in third column “SEED name”, Location and Channel SEED codes can be configured. Options are greyed out with default values applied, they can be edited by clicking on the checkbox at the start of the cell;
- in fourth column “RESPonse file” there are links to the RESP files associated to each of the seismic channels (see Section 2.10.2 for more details).

All streaming can be stopped by clicking the **Disable All Streams** button. The same configuration can be applied to recorded channels by clicking the **Copy to Data Record** button. Default channel configuration can be applied by clicking the **Restore Default** button;

Upon changing the sample rate, enabling a transform, or changing Location and Channel codes, the Minimus will need to be restarted for the changes to come into effect; this can be done by pressing the **Reboot** button.

During the reboot, the LEDs will flash, displaying the starting-up sequence (see Section 2.11.1) and the instrument’s web page will disconnect whilst it reboots.

Once the Minimus has successfully rebooted, the full web browser display and controls will be available for use.

If transmitting data over a network with high latency and/or low throughput, such as when the device is connected wirelessly to a modem, be aware of not having the total samples per second too high as streaming performance will be degraded.

---

### 2.4.2 GDI-Link Protocol

The Minimus can transmit data using the GDI (Güralp Data Interconnect)-link protocol. GDI-link supports both push/pull of data from/to the Minimus. See Section 2.4.2.1 to configure a data push to one or more remote clients (*e.g.* NAM).

GDI-link provides a highly efficient, low latency method of exchanging data via TCP between seismic stations and data centres. The protocol allows state-of-health information to be attached to the samples during transmission. The topology can be many-to-one or one-to many. This means that a receiver can accept data from multiple

transmitters and a single transmitter can send data to multiple receivers, allowing maximum flexibility for configuring seismic networks. GDI-link streams data sample-by-sample (instead of assembling them into packets) to minimise transmission latency.

A significant advantage of GDI-link is that it can stream data pre-converted into real physical units instead of just as raw digitiser counts, removing a requirement for receivers to be aware of calibration values.

For more information on GDI-link, please refer to Güralp manual **SWA-RFC-GDIL**.

### 2.4.2.1 GDI push (auto-connection)

A Minimus normally acts as a GDI server, where a client initiates a connection to pull data from it. This is the mechanism explained above and used when the GDI viewer in Discovery is launched (from the main menu, right click on the instrument, hover over "Live View" and select "GDI").

The "GDI auto-connection" feature enables the Minimus to establish outgoing network connections to push data to one or more remote clients, such as Platinum systems or an Earthworm system running the `gdi2ew` plug-in.



**Caution:** Either configure the auto-connection on the Minimus OR the client to pull data from it. If the client is pulling data from the Minimus, leave the "GDI auto-connection settings" fields empty. Configuring both ends may cause problems.

To configure an auto-connection, login to the Minimus as admin, type either the I.P. address or the hostname of the target client, a colon (:) and the port number (e.g. `192.0.2.91:1566` or `affinity10.example.com:1566`), into any of the connection fields in the "Network" tab of the web page.

GDI auto-connection settings							
Connection	<input type="text"/>	Connection	<input type="text"/>	Connection	<input type="text"/>	Connection	<input type="text"/>

When auto-connection from a Minimus to a host is configured, the Minimus will attempt to open a connection to the host. If it fails, it will re-try every 60 seconds. A suitably configured host will accept the connection and the Minimus will then negotiate a link and start streaming data.

If the connection drops, the Minimus will attempt every 60 seconds to reconnect.



**Note:** The default port number for a GDI-link receiver is 1566. Push servers will normally connect to this port. The default port number for a GDI-link transmitter is 1565. Receivers wishing to pull data will normally connect to this port. See Section 0 for a list of the network ports used by the Minimus.

## 2.4.3 SEEDlink Protocol

The Minimus can act as a SEEDlink server to send miniSEED data packets over a network connection. The SEEDlink server is enabled by default but it can be disabled and re-enabled if desired. The server has a configurable back-fill buffer.



**Note:** The Minimus SEEDlink back-fill implementation is packet-based.

When logged in as admin, the “Network” tab of the Minimus' web page allows the selection of the desired SEEDlink mode:

Network Config			
DHCP <input type="button" value="Enabled"/>			
DNS1 <input type="text" value="209.244.0.3"/>	DNS2 <input type="text" value="84.200.69.80"/>	<input type="button" value="Reboot"/>	
Web Login <input type="button" value="Required"/>	Username (Normal) <input type="text" value="user"/>	Password (Normal) <input type="text" value="*****"/>	HTTP Port <input type="text" value="80"/>
Web Timeout <input type="button" value="Never"/>	Username (Admin) <input type="text" value="admin"/>	Password (Admin) <input type="text" value="*****"/>	
SeedLink <input type="button" value="Enabled, 65536 records"/>	Send status.txt Every <input type="text" value="300"/> seconds	SeedLink Data Packet Format <input type="button" value="Optimal"/>	Send SeedLink EEW Packet Every <input type="text" value="0"/> deciseconds
TFTP Server <input type="button" value="Debug, 512 records"/>	TFTP File <input type="text"/>		
<b>Network</b>			
PTP Mode <input type="button" value="Run"/>	PTP Offset Correction <input type="text" value="0"/> nanoseconds	PTP Transmission Mode <input type="button" value="Unicast"/>	PTP Master IP <input type="text" value="0.0.0.0"/>
MTP Server <input type="button" value="Enabled, 2048 records"/>			
<b>Registry</b>			
Registry Up <input type="button" value="Enabled, 65536 records"/>	Group ID <input type="text" value="SOF"/>	Registry Address <input type="text" value="52.34.40.123"/>	

The choices are:

- “Enabled” - This is the normal operating mode. Choose between backfill buffer sizes of 2,048 records, 65,536 records or 139,264 records;
- “Disabled” - turns off the SEEDlink server; and
- “Debug” - this mode produces additional messages in the file `seedlink.log` (“Storage” tab) which may be helpful if trying to diagnose a problem. It is available with backfill buffer sizes as before and, additionally, a 512-record buffer.



**Note:** As a general guide, we find that 139,264 records is normally sufficient to store around one day of triaxial, 100 sps data.

### 2.4.3.1 Modified SEEDlink Protocol

Standard SEEDlink has a fixed packet size of 512 Bytes and each miniSEED packet is completely populated with data before it is transmitted. Minimus supports a modified version of SEEDlink that allows the transmission of incomplete packets. This improves latency.

 **Note:** The modified SEEDlink is only available for the low latency version of the main seismic channels. These are the equivalent of the standard seismic channels but are generated with causal low latency filters. In the Data Stream tab, they can be found in the “Low latency seismic channels” section.

By default, only a single tap (sample rate) is available, and the channel name ends in “C”, e.g. 0ACCZC or 0VELZC. To add an extra low latency channel tap, open the Minimus console from Discovery and type:

```
resource add extctaps n
```

with **n** the number of extra taps you wish to add. Following this command, the Minimus has to be rebooted. Type in the console:

```
reboot
```

After the reboot, open the Minimus webpage, navigate to the Data Stream or Data Record tab, set “Display Stream” to “All” and the newly added channels will appear in the “Low latency seismic channels” section.

[Status](#)   [Network](#)   [Setup](#)   [Trigger](#)   [Data Stream](#)   [Data Record](#)   [Storage](#)   [Login](#)   [Help](#)

System type: Minimus | Host label: SUPRT-MIN-TEST | Host name: MIN-A555 (10.20.1.82) | Serial number: 0A555

Data Stream			
<a href="#">Disable All Streams</a>	<a href="#">Restore default</a>	The “Disable All” and “Restore default” button will ALSO affect settings of any other sensors	<a href="#">Reboot</a>
<a href="#">Copy to Data Record</a>	“Copy to Data Record” will apply settings from this page to recording configuration of all of the sensors.		
Display Streams	Enabled Only	<input checked="" type="checkbox"/> Apply configuration for tap groups	Display On Page <span>Sensor 0</span>
Channels configuration			
Channel sampling rate	Data transform	SEED name - please use check-box to modify the default	RESPonse file - if available
Seismic channels			
0ACCZ0	100 Hz	Transforms Disabled for this tap	<input type="checkbox"/> DG.0A555.0J .HNZ <a href="#">RESP file 7</a>
0ACCN0	100 Hz	Transforms Disabled for this tap	<input type="checkbox"/> DG.0A555.0J .HNN <a href="#">RESP file 11</a>
0ACCE0	100 Hz	Transforms Disabled for this tap	<input type="checkbox"/> DG.0A555.0J .HNE <a href="#">RESP file 15</a>
0AUX0	100 Hz	Transforms Disabled for this tap	<input type="checkbox"/> DG.0A555.0J .HDF <a href="#">RESP file 5</a>
Low latency seismic channels			
0ACCZC	125 Hz	Transforms Disabled for this tap	<input type="checkbox"/> DG.0A555.0N .HNZ <a href="#">RESP file 19</a>
0ACCNC	125 Hz	Transforms Disabled for this tap	<input type="checkbox"/> DG.0A555.0N .HNN <a href="#">RESP file 21</a>
0ACCEC	125 Hz	Transforms Disabled for this tap	<input type="checkbox"/> DG.0A555.0N .HNE <a href="#">RESP file 23</a>
Auxiliary channels			
Tap UID: 0x0060 Chain Head: S0SeisELowLat Chain Description: Low-latency version of the main seismometer E chain Part of Triplet: Seismo Low Latency Triplet Sensitivity: 2.44E-6 m/s <sup>2</sup> /count Units: m/s <sup>2</sup>	Transforms Disabled for this tap	<input type="checkbox"/> DG.0A555.9S .BKO <a href="#">RESP file 635</a>	
	Transforms Disabled for this tap	<input type="checkbox"/> DG.0A555.1 .BQV <a href="#">RESP file 631</a>	
	Transforms Disabled for this tap	<input type="checkbox"/> DG.0A555.9Q .BIO <a href="#">RESP file 633</a>	
	Transforms Disabled for this tap	<input type="checkbox"/> DG.0A555.9K .BED	

The user can specify the rate at which miniSEED packets must be transmitted. If populating complete packets would result in this rate not being achieved, incomplete packets are transmitted instead. The number of samples in each packet, therefore, depends both upon this setting and on the sample rate.

Minimus, Minimus+, Fortimus, Certimus

Log in as Admin and navigate to the “Network” tab of the Minimus web page, under the “SeedLink settings” title, look for “Send SeedLink EEW Packets Every” option and select the interval in deciseconds (1 decisecond = 100 ms or 0.1 seconds) between miniSEED packets. (

Network Config			
DHCP	Enabled		
DNS1	209.244.0.3	DNS2	84.200.69.80
Web Login	Required	Username (Normal)	user
Web Timeout	Never	Username (Admin)	admin
SeedLink	Enabled, 65536 records	Send status.txt Every	300 seconds
Data Record Size	512 Bytes	SeedLink Data Packet Format	Optimal
	TFTP Server	10.30.255.197	TFTP File
			Send SeedLink EEW Packet Every
			10 deciseconds

The modified SEEDlink protocol also allows the use of 256-byte records as an alternative to the standard 512-byte format. The “Data Record Size” drop-down menu on the “Network” tab of the Minimus web page controls this behaviour. This option becomes available only when the “Send SeedLink EEW Packets Every” is different than 0.

Network Config			
DHCP	Enabled		
DNS1	209.244.0.3	DNS2	84.200.69.80
Web Login	Required	Username (Normal)	user
Web Timeout	Never	Username (Admin)	admin
SeedLink	Enabled, 65536 records	Send status.txt Every	300 seconds
Data Record Size	512 Bytes	SeedLink Data Packet Format	Optimal
	TFTP Server	10.30.255.197	TFTP File
			Send SeedLink EEW Packet Every
			10 deciseconds
			256 Bytes

 **Note:** Not all SEEDlink clients can accept 256-byte records. Consult your client's documentation if in doubt.

Using 256-byte packets instead of the standard 512-bytes is beneficial when transmitting incomplete packets. In fact, when incomplete packets are transmitted the miniSEED files will contain just a small amount of data while the rest of the file is empty (as the size of the packet is fixed). Reducing the packet size from 512 bytes to 256 bytes means that the resulting files would still contain all the data but the space they occupy in the SD card would be halved. If you are not recording data, or if you are not concerned about the space on the SD card, you can keep using the standard 512-byte packet size.

To test the SEEDlink server, Güralp recommends using the *slinktool* software for Linux, which is distributed by IRIS. For more information and to download a copy, see <https://ds.iris.edu/ds/nodes/dmc/software/downloads/slinktool/>.

To show a list of available miniSEED streams, issue the command:

```
slinktool -Q IP-Address
```

Which produces output like the following:

```
DG TEST 00 CHZ D 2016-09-13 10:42:18 - 2016-09-13 10:46:56
```

## Minimus, Minimus+, Fortimus, Certimus

```
DG TEST 01 HHZ D 2016-09-13 10:42:18 - 2016-09-13 10:46:56
DG TEST 00 CHN D 2016-09-13 10:42:18 - 2016-09-13 10:46:56
DG TEST 01 HHN D 2016-09-13 10:42:18 - 2016-09-13 10:46:56
DG TEST 00 CHE D 2016-09-13 10:42:18 - 2016-09-13 10:46:56
DG TEST 01 HHE D 2016-09-13 10:42:18 - 2016-09-13 10:46:56
DG TEST 00 MHZ D 2016-09-13 10:42:18 - 2016-09-13 10:46:56
DG TEST 00 MHN D 2016-09-13 10:42:18 - 2016-09-13 10:46:56
DG TEST 00 MHE D 2016-09-13 10:42:18 - 2016-09-13 10:46:56
```

To print miniSEED data records of a single channel, run the following command:

```
slinktool -p -S DG_TEST:00HNZ.D IP-Address
```

Which produces the following output:

```
DG_TEST_00_HNZ, 412 samples, 100 Hz, 2016,257,10:43:42.000000 (latency ~2.9 sec)
DG_TEST_00_HNZ, 415 samples, 100 Hz, 2016,257,10:43:46.120000 (latency ~2.6 sec)
DG_TEST_00_HNZ, 416 samples, 100 Hz, 2016,257,10:43:50.270000 (latency ~3.0 sec)
DG_TEST_00_HNZ, 413 samples, 100 Hz, 2016,257,10:43:54.430000 (latency ~2.6 sec)
DG_TEST_00_HNZ, 419 samples, 100 Hz, 2016,257,10:43:58.560000 (latency ~3.0 sec)
DG_TEST_00_HNZ, 418 samples, 100 Hz, 2016,257,10:44:02.750000 (latency ~2.6 sec)
DG_TEST_00_HNZ, 415 samples, 100 Hz, 2016,257,10:44:06.930000 (latency ~3.0 sec)
```

The SEEDlink server on the Minimus also supports the use of the “?” character as a wild card within network, station, and channel codes. This allows you to request multiple streams using a single command.



**Note:** Because the ? character has special meaning to the shell, it is safest to quote this character with a preceding backslash ('\') when used in command arguments.

## 2.4.4 QSCD

The Minimus can push data in QSCD format (**Quick Seismic Characteristic Data**) to one or more clients, using outgoing network connections.

To configure a connection, log into the web page interface as Admin, navigate to the “Network” tab and locate the “QSCD” section, as shown below. Type either the I.P. address or the hostname of the target client into any of the “Server” fields. This will push data using UDP port 9000, which is the default. If you wish to use a different port number, add a colon (':') and the port number to the end of the specification. For example, *192.0.2.91:9876* or *qscd.server.com:9876*.

QSCD			
QSCD code sensor	Sensor 0 ▾	QSCD code	QSCD0
Connection		Connection	
		Connection	
		Connection	

The Minimus does not automatically send all data when using the QSCD protocol. Channels to be transmitted must be selected (in Z/N/E triplets) and each channel passed through a QSCD transform. See Section 2.8.12 for details on how to configure this transform.

Use the “QSCD code sensor” drop-down menu to select the sensor and assign the desired QSCD code.

---

## 2.4.5 Scream! (GCF Format + Scream Protocol)

The Minimus can act as a Scream! Server and stream data by sending GCF (Güralp Compressed Format) packets over a network connection using the Scream! data-transmission protocol.

This is primarily intended to support Güralp’s Scream! Software or any software that can communicate using the Scream! Protocol, including Earthworm.

For more information, please refer to Scream! manual: [MAN-SWA-0001](#)



## 2.5 Synchronisation of the Sample-Clock

The Minimus system synchronises its sample clock using an attached GNSS receiver or, if that is not available, Precision Time Protocol (PTP). The currently supported GNSS systems are Navstar (GPS), GLONASS, BeiDou and Galileo.



**Note:** The GNSS can use only three different types of satellites simultaneously and GPS is always used, if available. The other two spots available can be either GLONASS, BeiDou or Galileo.

If visibility of the satellite constellation is available, this is the most accurate way to synchronise your digitiser. The accessory pack typically delivered together with instruments includes a combined GNSS antenna and receiver for this purpose: see individual manuals for more details: <https://www.guralp.com/technical-library/manuals/>.

---

### 2.5.1 GNSS

Information about the status of the GNSS receiver is available in the “Status” tab of the instrument’s web page.

A number of GNSS reporting parameters are given, including:

- Connection status
- Last GNSS update (sync) & last GNSS lock date/time
- GNSS Stability:
  - 0% = no receiver connected;
  - 1% = receiver connected, but waking up (this can occur if the GNSS receiver has been moved a long distance since last power-up).
  - 2-99% = view of sky obstructed.
  - 100% = normal operation with clear view of sky
- Latitude, longitude, altitude
- Horizontal dilution of precision (quality of satellite fix due to position of satellites relative to receiver)
- GNSS PPS status
- GNSS NMEA streaming
- GNSS lock state (2D/3D)
- Number of available satellites (in use / in view)

The screenshot displays the Minimus web interface. At the top right, the Guralp logo is accompanied by the tagline "UNDERSTAND OPTIMISE PROTECT". Below this, the word "Minimus" is displayed. A navigation menu includes "Status", "Network", "Setup", "Trigger", "Data Stream", "Data Record", "Storage", "Logout", and "Help". The "Status" page shows system information: "System type: Minimus | Host label: SPRT-MIN | Host name: MIN-C555 (10.10.0.10) | Serial number: 00C555".

**System Status**

General information					
Host name	MIN-C555	Host label	SPRT-MIN	System type	Minimus
Serial number	00C555	Firmware version	2.0-7548	IPv4 address	10.10.0.10 (DHCP)
Digitiser temperature	29.105 °C	Digitiser humidity	26.23%	Input voltage	12.920 V
System time	9:03:39 AM Fri 8-Nov-2019	Uptime	16h 51m 26s	Power over Ethernet voltage	0.000 V
				ETH status	sckt: 12/20 data: 2/6

**GNSS Status**

GNSS connection status	Connected	Last timestamp	2019-11-08 09:03:38	
Last lock time	2019-11-07 16:14:26	GNSS stability	100%	
Latitude	51.3608	Longitude	-1.163	
Altitude	116.5	Horizontal dilution of precision	0.92	
GNSS PPS status	Trusted Pulsing	GNSS NMEA stream	Input OK	
GNSS Lock state	3D locked	Number of satellites	Used: 12 In view: 12	

**Data record status**

microSD status	Recording	microSD total	60686336 KiB	microSD used	1298968 KiB	microSD free	97%
----------------	-----------	---------------	--------------	--------------	-------------	--------------	-----

**Sensors**

Number of sensors detected	1					
<b>Sensor0</b>	Serial number (0)	TF064	Firmware ver (0)	6.0		
	Integrator Z (0)	-6	Integrator N (0)	-5	Integrator E (0)	-6
	Seismometer Z (0)	62	Seismometer N (0)	287	Seismometer E (0)	481

Guralp Systems Limited  
 Midas House, Calleva Park, Aldermaston, Reading, RG7 8EA, UK  
 Tel: +44 118 981 9056, Fax: +44 118 981 9943  
 E-Mail: sales@guralp.com, support@guralp.com

## 2.5.2 PTP (Precision Time Protocol)

The Minimus system supports timing provided through PTP. The IEEE 1588 Precision Time Protocol (PTP) is a network protocol which uses modified network hardware to accurately time-stamp each PTP packet on the network at the time of transmission, rather than at the time that the packet was assembled. If you do not have an existing PTP infrastructure, the simplest way to use PTP is to add a "grand-master clock" to the same network segment as the digitisers. A typical such clock is the Omicron OTMC 100, which has an integrated GNSS antenna and receiver which it uses as its own synchronisation source. PTP timing can be extended over up to 100 metres of Ethernet cable or longer distances when fibre-optic cable is used. PTP is significantly more accurate than NTP but generally requires specialised hardware support.

The screenshot shows the Minimus web interface. At the top right, there is a logo for 'güralp' and the text 'UNDERSTAND OPTIMISE PROTECT'. Below the logo is the word 'Minimus'. A navigation menu includes 'Status', 'Network', 'Setup', 'Trigger', 'Data Stream', 'Data Record', 'Storage', 'Logout', and 'Help'. The 'Status' tab is selected. Below the navigation menu, there is a system information line: 'System type: Minimus | Host label: SPRT-MIN | Host name: MIN-C555 (10.10.0.10) | Serial number: 00C555'. The main content area is divided into several sections:

- System Status**: A table with columns for Host name, Serial number, Digitiser temperature, System time, Host label, Firmware version, Digitiser humidity, Uptime, System type, IPv4 address, Input voltage, ETH status, Product type, SEED network and station, Power over Ethernet voltage, and DG.TEST (No site).
- GNSS Status**: A table with columns for GNSS connection status, Last timestamp, Last lock time, Latitude, Altitude, GNSS PPS status, GNSS Lock state, GNSS stability, Longitude, Horizontal dilution of precision, GNSS NMEA stream, and Number of satellites. A map is shown to the right of this table.
- PTP Status**: A table with columns for PTP state, Last PTP timestamp, Master IPv4 address, Network path delay, Last PTP lock time, Master clock class, Network jitter estimate, Master clock accuracy, Network outliers, PTP stability, and Master time source.
- Data record status**: A table with columns for microSD status, microSD total, microSD used, and microSD free.
- Sensors**: A table with columns for Number of sensors detected, Sensor ID, Serial number, Integrator Z, Seismometer Z, Firmware ver, Integrator N, Seismometer N, Integrator E, and Seismometer E.

At the bottom of the page, there is contact information for Güralp Systems Limited, including their address, telephone number, fax number, and email addresses.

In the "Status" tab of the Minimus web page, a number of reporting parameters are given, including:

- PTP state
- Last PTP time-stamp and last PTP lock date/time
- PTP Stability:
  - Standby ⇒ PTP is running but timing is provided by GNSS;
  - No Master ⇒ PTP not available;
  - 1-100% ⇒ PTP locking process indicator. 100% indicates a time accuracy of better than 200 ns.
- Master IPv4 address
- Master clock class and accuracy
- Master time source
- Network path delay
- Network jitter estimate: quality indicator
- Network outliers

In the 'PTP Mode' section under the heading "Network Timing" there are four options:

- **Disabled** ⇒ PTP is never used (default settings).
- **Run if needed – Offline backup** ⇒ PTP is automatically enabled whenever the GNSS signal is lost. It is disabled while GNSS is available. This mode is used to minimise network traffic when GNSS is the primary timing source.
- **Run always – Online backup** ⇒ PTP is always running but GNSS is used as the primary timing source. This mode is useful for faster fall-back from GNSS to PTP timing and for validation that PTP is available.
- **Run always – Override GPS** = PTP is always running and takes priority over GNSS. This mode is useful in a system where PTP is the primary timing source, but GNSS may occasionally be connected for validation purposes.

Network Timing			
PTP Mode	Run always - Override GPS	PTP Offset Correction	0 nanoseconds
	Disabled	PTP Transmission Mode	Unicast
NTP Server	Run if needed - Offline backup	PTP Master IP 0.0.0.0	
Registry	Run always - Online backup		
Registry Group ID	Run always - Override GPS	SOF	Registry Address 52.34.40.123

PTP can be configured for multicast or unicast mode. In unicast mode, the server I.P. address must be specified. This is available as admin from the digitiser's web page in the "Network" tab..

Network Timing			
PTP Mode	Run always - Override GPS	PTP Offset Correction	0 nanoseconds
		PTP Transmission Mode	Unicast
NTP Server	Pool		PTP Master IP 0.0.0.0
			Multicast
			Unicast

### 2.5.3 NTP (Network Time Protocol)

NTP is only used for setting the system's internal clock at boot-up and it is not used for sample timing. However, if neither GNSS and PTP are available, but NTP is locked and the sample clock's time is more than 5 seconds different from NTP's time, the sample clock will be adjusted (in a step-change) to NTP time.



**Note:** The precision provided by NTP is significantly lower than the precision provided by PTP and GNSS. Therefore, the time stamp provided by the NTP server should NOT be used to interpret seismic data.

By default, the NTP server option (located under the "Network" tab of the instrument's web page, when logged in as Admin) is set to "Pool" which uses the virtual server pool `pool.ntp.org`. This accesses a dynamic collection of networked computers that voluntarily provide moderately accurate time via the NTP to clients worldwide.

## Minimus, Minimus+, Fortimus, Certimus

Network Timing					
PTP Mode	Disabled	PTP Offset Correction	0 nanoseconds	PTP Transmission Mode	Multicast
NTP Server	Pool				
Registry	Disabled				
Registry Update	Even	Group ID	SOF	Registry Address	52.34.40.123
	Static				

Alternatively, it is possible to specify the I.P. address of your preferred NTP server. To do this, select the “Static” option from the “NTP server” drop-down menu, which activates the “NTP IP Addr” setting, and enter the I.P. address of your NTP server here.

Typically, the name of your NTP server can be found in the Date & Time settings of your machine. After finding out the name of the server, its I.P. address can be discovered by pinging the NPT server, as in the figure below.

The image shows two side-by-side screenshots. The left screenshot is the Windows 'Date & time' settings window. It displays the current date and time as 12:27, 05 June 2024. Under 'Set time automatically', the 'On' toggle is selected. Under 'Set time zone automatically', the 'Off' toggle is selected. Under 'Set the date and time manually', there is a 'Change' button. Under 'Synchronize your clock', the last successful synchronization is shown as 05/06/2024 10:44:03, and the time server is listed as 'time.windows.com'. The right screenshot is a Windows Command Prompt window. It shows the command 'ping time.windows.com' being entered. The output shows four successful ping replies from 51.145.123.29 with varying response times (24ms, 20ms, 24ms, 19ms) and TTL values of 117. Ping statistics for 51.145.123.29 are also shown: Packets: Sent = 4, Received = 4, Lost = 0 (0% loss), with an average round trip time of 21ms.

## 2.6 Deploy Modes

The Minimus offers various deployment modes: "Normal", "Full power-save", "GPS power-save", "LAN power-save" and "GPS & LAN power-save" mode. The power-save modes make several configuration changes to reduce the unit's power consumption.

The desired mode can be specified by logging into the web interface as admin, navigating to the "Setup" tab, under "Digitiser Config" and using the "Deploy mode" drop-down menu to select an option. The final step is to click on the **Deploy** button and confirm or cancel the operation from the pop-up window that appears.

[Status](#)   [Network](#)   **[Setup](#)**   [Trigger](#)   [Data Stream](#)   [Data Record](#)   [Storage](#)   [Logout](#)   [Help](#)

System type: Minimus | Host label: SUPRT-MIN-TEST | Host name: MIN-C768 (10.20.1.87) | Serial number: 0C768

Digitiser Controls					
<b>Reboot</b>		<b>Reset All Settings</b>		The "Reset All Settings" button will ALSO affect settings on other pages	
Digitizer Config					
Auto Refresh	1	Auto Reboot	On Error	Low Latency Mode	Balanced
Startup with RTC	Disabled	Filter quality	High		
Host Label	SUPRT-MIN-TEST	Station Code	0C768	Network Code	DG
SeedLink SOH Location Code	00	Bluetooth PIN	0000	Bluetooth	Enabled
Deploy Mode	Normal	<b>Deploy</b>			
Applied Rota	Normal	<b>Perform deployment.</b>			
Analogue 0	Full Power Save GPS Power Save LAN Power Save GPS & LAN Power Save	Digital 2	0	Digital 3	0
Digital 1		Digital 4	0		

Changes are not applied immediately. A thirty-second count-down will start before the system enters power-save mode. The screen updates and the "Abort deployment" button is now active.:

Digitizer Controls					
<b>Reboot</b>		<b>Reset All Settings</b>		The "Reset All Settings" button will ALSO affect settings on other pages	
Digitizer Config					
Auto Refresh	1	Auto Reboot	On Error	Low Latency Mode	Balanced
Host Label	SPRT-MIN	Station Code	TEST	Network Code	DG
Bluetooth PIN	0000	Bluetooth	Enabled	Filter quality	High
Deploy Mode	Power Save	Auto Center Disable(hr)	12	<b>Deploy</b>	<b>Abort deployment</b>
You can abort deployment within		28s			

You can cancel the operation before the countdown is complete by clicking the **Abort deployment** button.

To verify if a power-save mode is enabled, open the Minimus' console and type:

```
powersave status
```

If the output is a message saying "power mode: Normal", no power-mode is enabled.

## 2.6.1 Full Power-Save Mode



**Caution:** The full power-save mode is currently only an experimental feature and should not be used for deployment. To achieve the minimum power consumption, Güralp recommend using the GPS & LAN power-save mode instead.

---

## 2.6.2 GPS Power-Save Mode

When the Minimus is deployed in GPS power-save mode, the GPS interface remains off most of the time and is only switched on periodically to maintain a stable GPS lock.



**Note:** In order to function, the GPS power-save mode requires the internal clock DAC frequency pulling channel (OCVDAC) to be enabled.

To exit the GPS power-save mode, either:

- Click the  button on the webpage
- Use the GüVü Bluetooth app (see Section 2.17 )
- Open the Minimus console from Discovery and type the command: `powersave off`
- Connect to the Minimus via a serial connection and type the command `powersave off`

---

## 2.6.3 LAN Power-Save Mode

When the Minimus is deployed in LAN power-save mode, the LAN interface gets permanently switched off.



**Caution:** The LAN power-save mode will disable the Ethernet module. You will not be able to continue to use the web interface.

To exit the LAN power-save mode, either:

- Use the GüVü Bluetooth app (see Section 2.17 )
- Connect to the Minimus via a serial connection and type the command `powersave off`
- Apply Power over Ethernet (PoE) if your instrument supports it. The application of PoE causes the system to boot in “Normal” mode.

After the LAN power-save mode is disabled, access to the webpage interface is possible.



## 2.6.4 GPS & LAN Power-Save Mode

This mode is a combination of the GPS power-save mode and the LAN power-save mode. Both the Ethernet and GNSS modules are disabled, with the GNSS interface switching on periodically to maintain a stable GPS lock.



**Caution:** The GPS & LAN power-save mode will disable the Ethernet module. You will not be able to continue to use the web interface.

To exit the GPS & LAN power-save mode, either:

- Use the GüVü Bluetooth app (see Section 2.17)
- Connect to the Minimus via a serial connection and type the command `powersave off`
- Apply Power over Ethernet (PoE) if your instrument supports it. The application of PoE causes the system to boot in “Normal” mode.

After the GPS & LAN power-save mode is disabled, access to the webpage interface is possible.

## 2.6.5 Maris Deployment

“Power Save” mode temporarily disables auto-centring of a connected Maris digital sensor, so that it is not continually re-centring while being lowered to the sea floor. When this mode is selected, the “Auto Centre Disable (hr)” input field appears. Use this to specify the length of time before auto-centring is re-enabled.

Digitizer Config					
Auto Refresh	<input type="text" value="1"/>	Auto Reboot	<input type="text" value="On Error"/>	Low Latency Mode	<input type="text" value="Balanced"/>
Host Label	<input type="text" value="SPRT-MIN"/>	Station Code	<input type="text" value="TEST"/>	Network Code	<input type="text" value="DG"/>
Bluetooth PIN	<input type="text" value="0000"/>	Bluetooth	<input type="text" value="Enabled"/>	Filter quality	<input type="text" value="High"/>
Deploy Mode	<input type="text" value="Power Save"/>	Auto Center Disable(hr)	<input type="text" value="12"/>	Deploy	<input type="text"/>



**Note:** Güralp recommend a value of 10 to 12 hours to fully cover the entire deployment procedure.

## 2.7 Configuration and Control of Connected Instruments

 **Note:** This section is relevant to Minimus and Minimus+ only.

### 2.7.1 Analogue Instruments

#### 2.7.1.1 Setting Instrument Type

To select the analogue sensor type, open the webpage interface and navigate to the “Setup” tab, under the “Analogue Sensor” header, there is a drop-down box for “Sensor Type”. The Minimus includes a choice of several Güralp sensors and accelerometers. If the sensor is not listed, select “Generic velocity” or “Generic acceleration”, according to the instrument's sensor type.

Analogue Sensors			
<b>Analogue to Digital Converter</b>			
Input gain	x1.0	Input range	+/- 20.48 V
		Input resolution	2.441 uV/count
<b>Identification</b>			
Sensor type	Guralp 3T	Status LED	Idle
<b>Mass Centring</b>			
Centre Mass	Guralp 3ESPC	Mass Readout Z	-0.00375 V
		Mass Readout N	-0.00312 V
		Mass Readout E	-0.00375 V
<b>Mass Locking</b>			
Lock Mass	Guralp 40T	Unlock Mass	
	Guralp Fortis		
<b>Calibration</b>			
Calibration	Guralp 5TC	Amplitude	100%
	Guralp 6T	Channel	Normal
<b>Selection</b>			
Digital Se	Guralp 3TB		
Initialisation	Guralp 3V/3ESP-V		
	Guralp 3T5TB		
	Guralp 54T		
	Generic velocity		
	Generic acceleration		

Guralp Systems Limited  
 Midas House, Calleva Park, Aldermaston, Reading, RG7 8EA, UK  
 Tel: +44 118 981 9056, Fax: +44 118 981 9943  
 E-Mail: sales@guralp.com, support@guralp.com

A reboot is required after this change.

#### 2.7.1.2 Setting Full-Scale for Güralp Fortis

The Güralp Fortis strong-motion accelerometer features a remotely switchable, full-scale option that can be controlled from inside Discovery. First, ensure that the physical gain switch on the underside of the Fortis is set to position “3” (as indicated by the engraving). See **MAN-FOR-0001** for more details.

To change the gain electronically, first, load the web page interface and navigate to the “Setup” tab, set the “Sensor Type” to “Güralp Fortis”. Setting this option will then enable the “Fortis Range” control. Under the “Fortis Range” drop-down box, select a full-scale setting (options: ±0.5g; ±1g; ±2g; ±4g), once the desired settings have been configured a Reboot will be required for these settings to take effect.

 **Note:** the sensitivity of Fortis is dependent on the full-scale. Make sure that the “Analogue Instrument Gain” setting in the Calibration Editor reflects the right full-scale option. More details in Section 2.7.1.5.

Setting the instrument type to “Fortis” will also change the miniSEED channel names to indicate that data is being recorded from an accelerometer, *e.g.* “HNZ”.

Analogue Sensors					
Analogue to Digital Converter					
Input gain	x1.0	Input range	+/- 20.48 V	Input resolution	2.441 uV/count
Identification					
Sensor type	Guralp Fortis				
Response					
Fortis Range	-0.5g; +0.5g	Fortis Loop	Normal		
Mass Centring					
Centre Mass	-1.0g; +1.0g	Mass Readout Z	-0.00375 V	Mass Readout N	-0.00312 V
	-2.0g; +2.0g				Mass Readout E
	-4.0g; +4.0g				-0.00375 V
Calibration					
Calibration		Amplitude	100%	Channel	Normal

### 2.7.1.3 Setting Digitiser Gain

The input gain can be controlled from the **Setup** tab of the web page interface using the “Input Gain” box. Guralp’s recommended gain options are: x1, x2, x4, x8 and x12, although any integer value can be entered here.

Analogue to Digital Converter					
Input gain	1	Input range	+/- 20.48 V	Input resolution	2.441 uV/count

The input range and resolution update automatically when the gain is changed. The gain in the RESP and Dataless SEED files are updated automatically.

### 2.7.1.4 Mass Control

The Minimus can lock, unlock and centre the masses of connected Guralp instruments, when applicable.

### Mass Centring

Many broadband seismometers (*e.g.* Guralp 3T and 3ESPC) support remote/electronic mass centring. Mass centring can be controlled from the “Setup” tab of the web page using the **Centre Mass** button. Mass centring status and control can also be found by right-clicking on the instrument and selecting “Centring”. Change the polarity of the control signal used for centring by using the drop-down menu “Centring Polarity” if necessary.

## Minimus, Minimus+, Fortimus, Certimus

Identification				
Sensor type	Generic velocity	Status LED	idle	
Mass Centring				
Centre Mass	Mass Readout Z	-0.00375 V	Mass Readout N	-0.00312 V
Mass Readout E		-0.00375 V		
Mass Locking				
Lock Mass	Unlock Mass			
Calibration				
Calibration	Off	Amplitude	100%	Channel
Normal				
Control Polarity				
Mass Lock Polarity	Active Low	Mass Unlock Polarity	Active Low	Centring Polarity
Active Low		Active Low		
Active High		Active High		
Cal Enable Polarity		Active Low		
Digital Sensors				
Selection				

### Mass Locking

Some seismometers require their masses to be locked before transportation. Mass locking can be controlled from the "Setup" tab of the web page using the **Lock Mass** and **Unlock Mass** buttons. Change the polarity of the control signals using the drop-down menu: "Mass Lock/Unlock Polarity", if necessary.

Analogue Sensors				
Analogue to Digital Converter				
Input gain	x1.0	Input range	+/- 20.48 V	Input resolution
2.441 uV/count				
Identification				
Sensor type	Generic velocity	Status LED	idle	
Mass Centring				
Centre Mass	Mass Readout Z	-0.00375 V	Mass Readout N	-0.00312 V
Mass Readout E		-0.00375 V		
Mass Locking				
Lock Mass	Unlock Mass			
Calibration				
Calibration	Off	Amplitude	100%	Channel
Normal				
Control Polarity				
Mass Lock Polarity	Active Low	Mass Unlock Polarity	Active Low	Centring Polarity
Active Low		Active Low		
Active High		Active High		
Cal Enable Polarity		Active Low		
Digital Sensors				
Selection				



**Note:** The mass lock control buttons are not displayed unless the selected sensor type has a mass-locking mechanism.

### 2.7.1.5 Instrument Response Parameters

Calibration is a procedure used to verify or measure the frequency response and sensitivity of a sensor. It establishes the relationship between actual ground motion and the corresponding output voltage. Calibration values, or response parameters, are the results of such procedures.

Response parameters typically consist of a sensitivity or "gain", measured at some specified frequency, and a set of poles and zeros for the transfer function that expresses the frequency response of the sensor. A full discussion of poles and zeros is beyond the scope of this manual.

The gain for a seismometer is traditionally expressed in *Volts per ms<sup>-1</sup>* and, for an accelerometer, in *Volts per ms<sup>-2</sup>*. Other instruments may use different units: an electronic thermometer might characterise its output in mV per °C.

## Minimus, Minimus+, Fortimus, Certimus

A calibration procedure is also used to establish the relationship between the input voltage that a digitiser sees and the output, in counts, that it produces. The results are traditionally expressed in *Volts per count*. Each Minimus is programmed at the factory so that it knows its own calibration values.

All Güralp sensors are fully calibrated before they leave the factory. The results are given in the calibration pack supplied with each instrument.

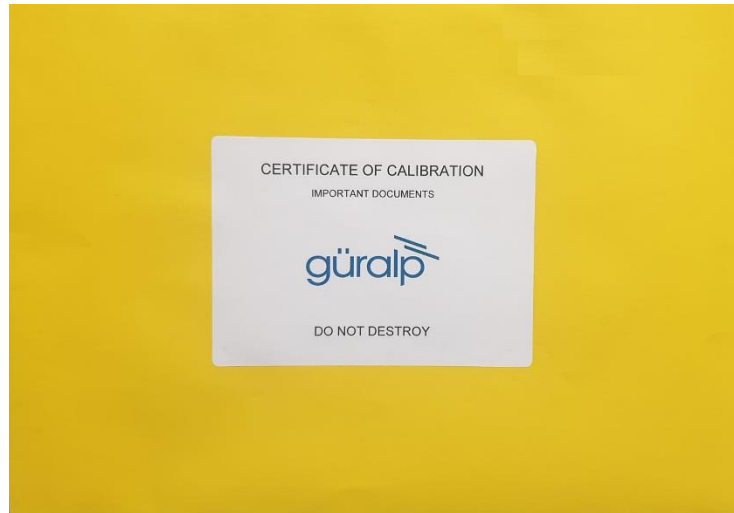

The Minimus requires analogue sensor calibration values to be input manually (*e.g.* Güralp Fortis, 3T, etc.).

To enter the calibration values for your analogue instruments, right-click the Minimus in Discovery's main window and select "Calibration" → "Edit Poles & Zeros".

## Minimus, Minimus+, Fortimus, Certimus

MIN-A555 - Calibration Editor - Discovery

Sensor0

Settings

Instrument serial number:  (instrument type)

\* Component Z   Component N   Component E   Component X   Mass Z   Ma

Units

Customize component input unit

Physical unit:  Unit modifier:

Parameters

Digitizer Volts per count  **V per count**

Analogue Instrument  **V per picocount (reciprocal: 0.247036)**

ADC Offset  **counts**

Coil constant  **A/m/s<sup>2</sup>**

Calibration resistor  **Ω**

Response

Normalizing factor

Poles (Hz)

Pole	Real	Imaginary	Unit
<input checked="" type="checkbox"/> Pole 0	<input type="text" value="-63"/>	<input type="text" value="+ i* -90.389999"/>	Hz
<input checked="" type="checkbox"/> Pole 1	<input type="text" value="-63"/>	<input type="text" value="+ i* 90.389999"/>	Hz
<input checked="" type="checkbox"/> Pole 2	<input type="text" value="-755.90002"/>	<input type="text" value="+ i* nan"/>	Hz
<input checked="" type="checkbox"/> Pole 3	<input type="text" value="-209.7"/>	<input type="text" value="+ i* nan"/>	Hz
<input type="checkbox"/> Pole 4	<input type="text" value="nan"/>	<input type="text" value="+ i* nan"/>	Hz
<input type="checkbox"/> Pole 5	<input type="text" value="nan"/>	<input type="text" value="+ i* nan"/>	Hz
<input type="checkbox"/> Pole 6	<input type="text" value="nan"/>	<input type="text" value="+ i* nan"/>	Hz
<input type="checkbox"/> Pole 7	<input type="text" value="nan"/>	<input type="text" value="+ i* nan"/>	Hz
<input type="checkbox"/> Pole 8	<input type="text" value="nan"/>	<input type="text" value="+ i* nan"/>	Hz
<input type="checkbox"/> Pole 9	<input type="text" value="nan"/>	<input type="text" value="+ i* nan"/>	Hz
<input type="checkbox"/> Pole 10	<input type="text" value="nan"/>	<input type="text" value="+ i* nan"/>	Hz

Zeros (Hz)

Zero	Real	Imaginary	Unit
<input type="checkbox"/> Zero 0	<input type="text" value="nan"/>	<input type="text" value="+ i* nan"/>	Hz
<input type="checkbox"/> Zero 1	<input type="text" value="nan"/>	<input type="text" value="+ i* nan"/>	Hz

System calibration values

This form has one tab for each seismic component, mass position and a calibration channel. The instrument's response values should be entered in here. These are:

- The **Digitiser Volts per Count (VPC)** – the ratio between the input voltage and the digitised output value (“counts”). This field will be populated automatically with the correct value for this input channel of the Minimus.

## Minimus, Minimus+, Fortimus, Certimus

- **Analogue Instrument Gain** – this specifies the output voltage of the seismometer per unit of ground motion, as measured at 1 Hertz. This information is normally provided on the calibration document that is shipped with the instrument. In the calibration document, this parameter is often referred to as “Velocity Output V/m/s” or “Acceleration Response V/m/s<sup>2</sup>” depending on the analogue instrument. This value can vary slightly across the three components.
- The **ADC offset** is the quiescent output seen when digitiser input is zero. This field will be populated automatically with the correct value for this input channel of the Minimus.
- The **Coil constant** is the coil constant for the component being calibrated, in A/ms<sup>-2</sup>, as given on the analogue sensor calibration sheet. This value is the same across all three components. This value is not relevant when Minimus is used with a Güralp Fortis accelerometer or Güralp Certis broad-band seismometer.
- The **Calibration resistor** is the value of the calibration resistor, in  $\Omega$ , as given on the sensor calibration sheet. This value is the same across all three components. This value is not relevant when Minimus is used with a Güralp Fortis accelerometer or Güralp Certis broad-band seismometer.
- The **Normalising factor** specifies the value that the transfer function (as specified by the poles and zeros) must be multiplied by in order to provide unity gain at 1 Hz. This value is the same across all three components.
- The **Poles** and **Zeros** describe the frequency and phase response of the component. *They must be specified in Hertz.* This information is normally provided on a calibration document that is shipped with the instrument. If poles and zeros are not included in your calibration document, nominal values can be found here: <https://www.guralp.com/apps/paz/>. This value is the same across all three components.



**Note:** If the calibration document is lost, please visit the website to learn how to request a copy (<https://www.guralp.com/customer-support>).

The calibration parameters for one component can be copied to any other component of the same instrument, or other instruments. This is especially useful for poles and zeros because they are typically identical for all three components of all instruments in a class.

Within the “Component configuration” section, the “Copy:” drop-down box allows the selection of what to copy: poles and zeros, parameters, or All(tab dependant). The destination sensor can be set in the “to sensor” box and takes the numeric identity of the sensor as detected by the Minimus. Finally the specific components can be selected in the “to component” drop-down box. Click on the  button to copy and paste the selected values. Finally click on  button to send the calibration values to the digitiser and save them permanently. Repeat this last step for the other axis. Note that  only sends the calibration of the selected axis.



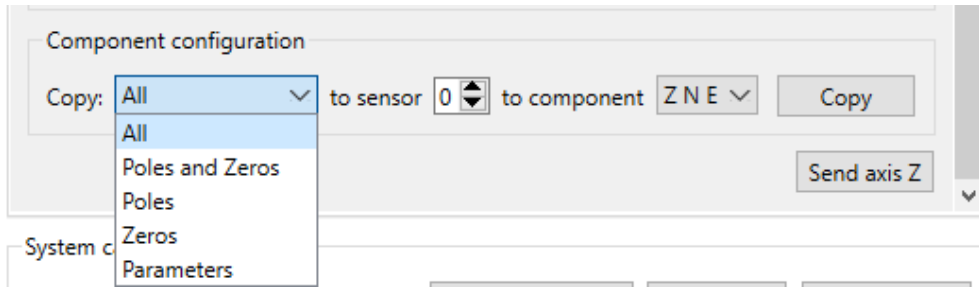

The overall system calibration parameters can be exported and saved in a file for future use by clicking on the **Export to file** button under “System calibration values”.

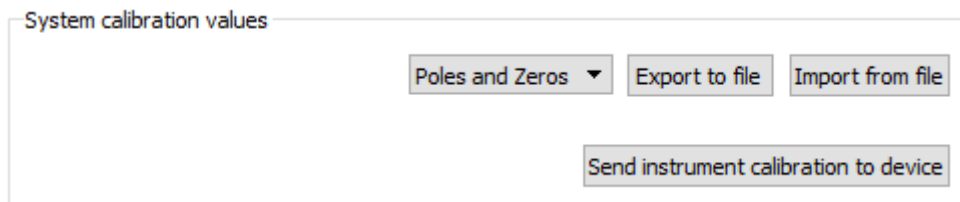

The resulting filename will have the extension “.conf”. Values from an existing calibration file can be imported using the **Import from file** button. The associated drop-down menu allows specification of what to import: poles and zeros, gains, or everything. Click on **Send instrument calibration to device** to send the calibration values to the digitiser and save them permanently.

 **Note:** When using Minimus+, this action will only send the calibration of the selected sensor. Click on the **Send to device** button to send the complete calibration to the digitiser.

---

## 2.7.2 Digital Instruments

Please refer to **MAN-RAD-0001** for full details on configuring and controlling compatible digital instruments, such as the Guralp Radian, connected to the Minimus.

---

## 2.7.3 Sensor Orientation and Installation Parameters

### 2.7.3.1 Applied Rotation

A MATLAB extension for Scream! allows easy determination of the exact orientation of a sensor relative to a surface reference sensor (which can be accurately aligned magnetically or geographically). The procedure is explained at <https://www.guralp.com/howtos/determining-sensor-orientation.shtml>.

The Relative Orientation extension of Scream! provides a correction angle that can be entered into the Sensor Orientation section of the Setup tab of the Minimus web page.

Digitizer Controls				
<input type="button" value="Reboot"/>		<input type="button" value="Reset All Settings"/>		The "Reset All Settings" button will ALSO affect settings on other pages
Digitizer Config				
Auto Refresh	<input type="text" value="1"/>	Auto Reboot	<input type="text" value="On Error"/>	Low Latency Mode
Host Label	<input type="text" value="SPRT-MIN"/>	Station Code	<input type="text" value="TEST"/>	Network Code
Bluetooth PIN	<input type="text" value="0000"/>	Bluetooth	<input type="text" value="Enabled"/>	Filter quality
Deploy Mode	<input type="text" value="Power Save"/>	Auto Center Disable(hr)	<input type="text" value="12"/>	<input type="button" value="Deploy"/>
Applied Rotation				
Analogue 0	<input type="text" value="0"/>			
Digital 1	<input type="text" value="0"/>	Digital 2	<input type="text" value="0"/>	Digital 3
Digital 5	<input type="text" value="0"/>	Digital 6	<input type="text" value="0"/>	Digital 8

This feature can be applied to analogue seismometers, accelerometers and also to Borehole or Post-hole Radars, when installed with a vertical orientation.



**Note:** The input rotation is automatically applied to both transmitted and recorded data.

### 2.7.3.2 Instrument Installation Parameters

The Dip (tilt angle from vertical), Azimuth (tilt direction from North) and Depth of analogue or digital sensors connected to the Minimus can be set in the "Setup" tab of the web page interface in the section "Applied Rotation". The instrument to which the displayed parameters apply is selected using the drop-down menu.

Applied Rotation				
Analogue 0	<input type="text" value="0"/>			
Digital 1	<input type="text" value="0"/>	Digital 2	<input type="text" value="0"/>	Digital 3
Digital 5	<input type="text" value="0"/>	Digital 6	<input type="text" value="0"/>	Digital 8
Sensor	<input type="text" value="Sensor 0"/>	Dip	<input type="text" value="0"/>	Azimuth
			<input type="text" value="0"/>	Depth
				<input type="text" value="0"/>



**Note:** The orientation and depth are not applied to the data, the parameters are only saved in the Dataless SEED.

### 2.7.4 Injecting a Calibration Signal

To check whether the analogue sensor(s) connected to the Minimus is correctly calibrated, go to the "Setup" tab of the web page interface and use the "Calibration" drop-down box to choose between Triangle, Step, Sine Wave and White Noise signal to be injected into the sensor's feedback loop.

# Minimus, Minimus+, Fortimus, Certimus

Analogue Sensors			
Analogue to Digital Converter			
Input gain	x1.0	input range	+/- 20.48 V
		input resolution	2.441 uV/count
Identification			
Sensor type	Guralp 3T	Status LED	Idle
Mass Centring			
Centre Mass		Mass Readout Z	-0.00375 V
		Mass Readout N	-0.00312 V
		Mass Readout E	-0.00375 V
Mass Locking			
Lock Mass		Unlock Mass	
Calibration			
Calibration	Triangle	Amplitude	100%
	Off		Channel
	Triangle		Normal
	Square		
	White Noise		
Selection			
Initialisation			

Guralp Systems Limited

Adjust the calibration signal amplitude at 100%, 50%, 25% or 12.5% of the DAC's full range.

Calibration			
Calibration	Triangle	Amplitude	100%
			Channel
			Normal
Selection			
Initialisation	Complete		

Guralp Systems Limited

Finally, enable the calibration on all three axes of the selected analogue sensor.



Calibration			
Calibration	Triangle	Amplitude	100%
			Channel
			Normal
Selection			
Initialisation	Complete		

Guralp Systems Limited  
 Midas House, Calleva Park, Aldermaston, Reading  
 Tel: +44 118 981 9056, Fax: +44 118 981  
 E-Mail: sales@guralp.com, support@guralp.com

 Note: The calibration channel, named nVELC0 (or nACCC0), produces an output only if the calibration is in progress.

While the calibration is in progress, the webpage shows the warning message

**Calibration in progress** and Discovery flags the status icon in yellow.

			DEMO 253	Minimus	MIN-AF55	2.0-
<p><b>This system is now operating in calibration mode</b></p> <p>System: <b>ACTIVE</b></p> <p>Timing: <b>Error</b> (GNSS Error, PTP Error, PPS Error.)</p> <p>Storage: <b>OK</b> (Storage OK., Storage free space is in GREEN zone., Free space: 99.67%, Available space: 60686336KiB, Used space: 199308KiB)</p>						

## 2.8 Transforms

The Minimus is capable of applying mathematical transforms to the streamed and recorded data. These include low-pass and high-pass filters, integration, differentiation, rotation, STA/LTA ratio etc.

When a transform is activated on a particular channel, the web page interface will update allowing the selection of the specific transform to be applied, from the same drop-down box. After rebooting the Minimus, the resulting streamed (or recorded, according to the chosen configuration) data output is automatically transmitted and/or recorded with the transform applied. The units-of-measure are re-calculated accordingly.

Transform functions are enabled or disabled from the “Data Stream” and “Data Record” tabs for each channel.

 **Note:** To enable or disable a transform on any channel, it is necessary to reboot the Minimus. Transforms can be applied only on enabled channels.

Some transforms require parameters such as frequencies or coefficients. For these, the user can either use a fixed, default set, or create their own custom set.

To use customised parameters, visit the “Transform Parameters” tab and find the “Parameter Source” drop-down menu, select the “Saved User Parameters” option. Type in the required parameters and then click **Save Parameters** to store them. It is possible to reset the “Saved User Parameters” by clicking **Save Parameters** while “Default parameters” is selected, which will overwrite the customised parameters with the default values.

Parameter Source	Default Parameters	Save Parameters
Select which transform parameters to use: Defaults or Recall saved user settings from memory	Default Parameters	
	Saved User Parameters	

The various transforms are described in the following section:



**Caution:** The **Disable All Streams** button at the top of the "Data Stream" section does not disable *transforms* for all streams. It stops *transmission* of all streams, which may not be what you intend.

## 2.8.1 Pass-Through

This null transform simply outputs a copy of the input data, without applying any transform. It has no configuration parameters.

[Status](#) [Network](#) [Setup](#) [Power](#) [Trigger](#) [Data Stream](#) [Data Record](#) [Transforms](#) [Storage](#) [Logout](#) [Help](#)

System type: Minimus | Host label: Support | Host name: MIN-C555 (10.10.0.13) | Serial number: 50517

Data Stream			
Display Streams	All	Transform	Try to NOT change any SEED Location
Reboot	Disable All Streams	Reset All Settings	Display On Page
			Sensor0
0XCHN0	200 Hz	Transforms Disabled	<input type="checkbox"/> DG.TEST,00  HDF
0ACCZ0	200 Hz	Pass-through	<input type="checkbox"/> DG.TEST,00  HHZ
			<a href="#">RESP file 5</a>
			<a href="#">RESP file 7</a>

[Status](#) [Network](#) [Setup](#) [Power](#) [Trigger](#) [Data Stream](#) [Data Record](#) [Transforms](#) [Storage](#) [Logout](#) [Help](#)

System type: Minimus | Host label: Support | Host name: MIN-C555 (10.10.0.13) | Serial number: 50517

Configure Transforms	
	0ACCZ0
Selected Transform	Pass-through



**Note:** This transform is selected by default when transforms are first enabled or when an invalid transform is selected. Do not use pass-through as a method of disabling transforms: instead, select "Disable Transforms for this tap" from the drop-down menu next to each stream on the "Data Streams" tab,

## 2.8.2 Differentiation

This transform differentiates the input data, for example if the input is a velocity (ms<sup>-1</sup>) channel, the output will be acceleration (ms<sup>-2</sup>). It has no configuration parameters.

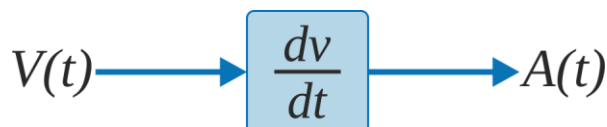

## Minimus, Minimus+, Fortimus, Certimus

Status Network Setup Power Trigger **Data Stream** Data Record Transforms Storage Logout Help

System type: Minimus | Host label: Support | Host name: MIN-C555 (10.10.0.13) | Serial number: 50517

Data Stream			
Display Streams	All	Transform	Try to NOT change any SEED Location
Reboot		Disable All Streams	Reset All Settings
0XCHN0	200 Hz	Transforms Disabled	<input type="checkbox"/> DG.TEST,00 HDF
0ACCZ0	200 Hz	Differentiation	<input type="checkbox"/> DG.TEST,00 HHZ

The "Reset All Settings" button will ALSO affect settings on other pages

[RESP file 5](#)

[RESP file 7](#)

---

Status Network Setup Power Trigger Data Stream Data Record **Transforms** Storage Logout Help

System type: Minimus | Host label: Support | Host name: MIN-C555 (10.10.0.13) | Serial number: 50517

Configure Transforms	
0ACCZ0	
Selected Transform	Differentiation

### 2.8.3 1<sup>st</sup> Order LPF

This transform applies a first-order low-pass filter to the input data.



The single configurable parameter is "Corner Frequency": this specifies, in Hz, the frequency at which the output power is attenuated by -3 dB. Above this frequency, output power is attenuated by a further 6 dB per octave or 20 dB per decade.

Status Network Setup Power Trigger **Data Stream** Data Record Transforms Storage Logout Help

System type: Minimus | Host label: Support | Host name: MIN-C555 (10.10.0.13) | Serial number: 50517

Data Stream			
Display Streams	All	Transform	Try to NOT change any SEED Location
Reboot		Disable All Streams	Reset All Settings
0XCHN0	200 Hz	Transforms Disabled	<input type="checkbox"/> DG.TEST,00 HDF
0ACCZ0	200 Hz	1st Order LPF	<input type="checkbox"/> DG.TEST,00 HHZ

The "Reset All Settings" button will ALSO affect settings on other pages

[RESP file 5](#)

[RESP file 7](#)

---

Status Network Setup Power Trigger Data Stream Data Record **Transforms** Storage Logout Help

System type: Minimus | Host label: Support | Host name: MIN-C555 (10.10.0.13) | Serial number: 50517

Configure Transforms	
0VELZ0	
Selected Transform	1st Order LPF
Parameter Source	Default Parameters
Corner Frequency (Hz)	10

### 2.8.4 1<sup>st</sup> Order HPF

This transform applies a first-order high pass filter to the input data.



The output is the difference between a low-pass filtered copy of the signal and the unfiltered signal.

## Minimus, Minimus+, Fortimus, Certimus

The single configurable parameter is "Corner Frequency": this specifies, in Hz, the frequency at which the output power is attenuated by -3 dB. Below this frequency, output power is attenuated by a further 6 dB per octave or 20 dB per decade.

 **Note:** The high-pass filter is implemented by subtracting the output of a low-pass filter from the unfiltered data:

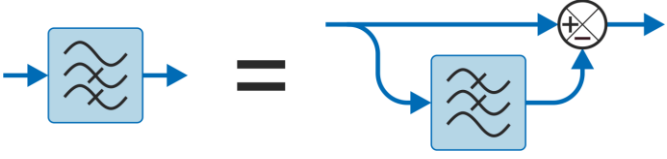

Status Network Setup Power Trigger **Data Stream** Data Record Transforms Storage Logout Help

System type: Minimus | Host label: Support | Host name: MIN-C555 (10.10.0.13) | Serial number: 50517

Data Stream			
Display Streams	All	Transform	Try to NOT change any SEED Location
Reboot	Disable All Streams	Reset All Settings	Display On Page
0XCHN0	200 Hz	Transforms Disabled	<input type="checkbox"/> DG.TEST_00 HDF
0ACCZ0	200 Hz	1st Order HPF	<input type="checkbox"/> DG.TEST_00 HHZ

The "Reset All Settings" button will ALSO affect settings on other pages

[RESP file 5](#)

[RESP file 7](#)

Status Network Setup Power Trigger Data Stream **Transforms** Storage Logout Help

System type: Minimus | Host label: Support | Host name: MIN-C555 (10.10.0.13) | Serial number: 50517

Configure Transforms	
OVELZ0	
Selected Transform	1st Order HPF
Parameter Source	Default Parameters
Corner Frequency (Hz)	10

Save Parameters

### 2.8.5 1<sup>st</sup> Order Band/Notch Filter

This transform applies first-order band stop or Notch filter to the input data.



The band-stop filter is implemented as a configurable chain of two components:

A 1<sup>st</sup> order high pass filter (implemented using an LPF and a subtractor, as described in Section 2.8.4), to gradually attenuate low-frequency integrator drift.

A 1<sup>st</sup> order low pass filter (implemented as described in Section 2.8.3).

The configurable parameters are the "High Pass Frequency" (HPF corner frequency as defined in Section 2.8.4) and the "Low Pass Frequency" (LPF corner frequency as defined in Section 2.8.3).



## Minimus, Minimus+, Fortimus, Certimus

Status Network Setup Power Trigger **Data Stream** Data Record Transforms Storage Logout Help

System type: Minimus | Host label: Support | Host name: MIN-C555 (10.10.0.13) | Serial number: 50517

Data Stream			
Display Streams	All	Transform	Try to NOT change any SEED Location
Reboot	Disable All Streams	Reset All Settings	Display On Page
0XCHN0	200 Hz	Transforms Disabled	Sensor0
0ACCZ0	200 Hz	Band/Notch Filter (1st Order)	The "Reset All Settings" button will ALSO affect settings on other pages
		<input type="checkbox"/> DG.TEST.00	HDF
		<input type="checkbox"/> DG.TEST.00	HHZ
			<a href="#">RESP file 5</a>
			<a href="#">RESP file 7</a>

Status Network Setup Power Trigger Data Stream Data Record **Transforms** Storage Logout Help

System type: Minimus | Host label: Support | Host name: MIN-C555 (10.10.0.13) | Serial number: 50517

Configure Transforms			
0VELZ0			
Selected Transform	Band/Notch Filter (1st Order)	Parameter Source	Default Parameters
High Pass Frequency (Hz)	0.1	Low Pass Frequency (Hz)	50
Save Parameters			

### 2.8.6 2<sup>nd</sup> Order Biquad

This transform applies a second-order bi-quadratic filter to the input data.

$$H(z) = \frac{b_0 + b_1 z^{-1} + b_2 z^{-2}}{a_0 + a_1 z^{-1} + a_2 z^{-2}}$$

The biquad filter is a second-order recursive linear filter, containing two poles and two zeros. In the Z-plane, the transfer function is the ratio of two quadratics in z, as shown.

The two configurable parameters are:

- "Corner Frequency": this specifies, in Hertz, the frequency at which the output power is attenuated by -3 dB; and
- "Type":
  - 0: low-pass mode; and
  - 1: high-pass mode.

Status Network Setup Power Trigger Data Stream Data Record **Transforms** Storage Logout Help

System type: Minimus | Host label: Support | Host name: MIN-C555 (10.10.0.13) | Serial number: 50517

Data Stream			
Display Streams	All	Transform	Try to NOT change any SEED Location
Reboot	Disable All Streams	Reset All Settings	Display On Page
0XCHN0	200 Hz	Transforms Disabled	Sensor0
0ACCZ0	200 Hz	2nd Order Biquad	The "Reset All Settings" button will ALSO affect settings on other pages
		<input type="checkbox"/> DG.TEST.00	HDF
		<input type="checkbox"/> DG.TEST.00	HHZ
			<a href="#">RESP file 5</a>
			<a href="#">RESP file 7</a>

Status Network Setup Power Trigger Data Stream Data Record **Transforms** Storage Logout Help

System type: Minimus | Host label: Support | Host name: MIN-C555 (10.10.0.13) | Serial number: 50517

Configure Transforms			
0ACCZ0			
Selected Transform	2nd Order Biquad	Parameter Source	Default Parameters
Type (HPF/LPF)	0	Corner Frequency (Hz)	10
Save Parameters			

0 = Low Pass Filter, 1 = High Pass Filter

## 2.8.7 Integration

This transform integrates the input data, e.g. if the selected channel unit is velocity (ms<sup>-1</sup>), the output produced is displacement (m).

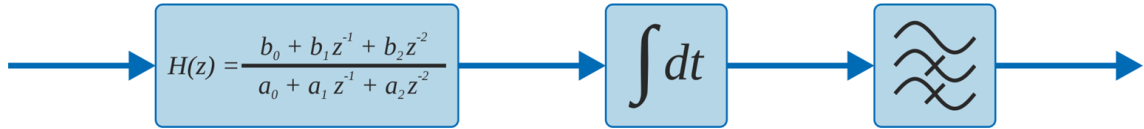

The integration transform is implemented as a configurable chain of three components:

- A DC filter (2<sup>nd</sup> order high-pass bi-quadratic) removes any DC component, which would cause the output to grow without limit;
- The integrator itself; and
- A 1<sup>st</sup> order high pass filter (implemented using an LPF and a sub-tractor, as described in Section 2.8.4), to gradually attenuate low-frequency integrator drift.

The configurable parameters are:

- "DC Cut-off Frequency": this specifies the -3 dB point (in Hertz) for the initial high-pass filter;
- "Output Cut-off Frequency": this specifies the -3 dB point (in Hertz) for the output high-pass filter;
- "Configuration Mode", which configures how many elements of the chain are used. The options are:
  - Apply only the initial DC filter;
  - Apply the DC filter and the integrator; and
  - Apply the DC filter, the integrator and the output HPF.

Status Network Setup Power Trigger Data Stream Data Record Transforms Storage Logout Help

System type: Minimus | Host label: Support | Host name: MIN-C555 (10.10.0.13) | Serial number: 50517

Data Stream			
Display Streams	All	Transform	Try to NOT change any SEED Location
Reboot		Disable All Streams	Reset All Settings
0XCHN0	200 Hz	Transforms Disabled	<input type="checkbox"/> DG.TEST,00 HDF
0ACCZ0	200 Hz	Integration	<input type="checkbox"/> DG.TEST,00 HHZ
			The "Reset All Settings" button will ALSO affect settings on other pages
			<a href="#">RESP_file_5</a>
			<a href="#">RESP_file_7</a>

Status Network Setup Power Trigger Data Stream Transforms Storage Logout Help

System type: Minimus | Host label: Support | Host name: MIN-C555 (10.10.0.13) | Serial number: 50517

Configure Transforms			
0ACCZ0			
Selected Transform	Integration	Parameter Source	Default Parameters
DC Cut-off Frequency	0.5	Output Cut-off Frequency	0.003
		Configuration Mode	2
0 = DC filter output 1 = DC HPF + Integration 2 = DC HPF + Integration + HPF			

## 2.8.8 Double Integration

This transform integrates the input data twice so, for example, if the selected channel is acceleration ( $\text{ms}^{-2}$ ), the output produced is displacement (m).

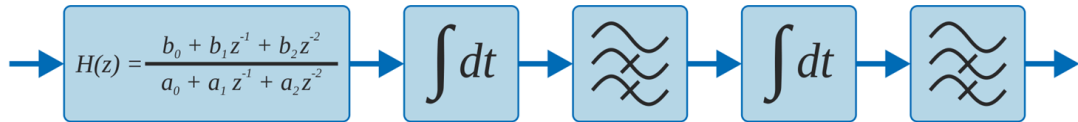

Analogously to the single integrator, the double integrator applies an initial DC high-pass filter and then two further high-pass filters, one at the output of each integrator. The high-pass filters are implemented using an LPF and a subtractor

The configurable parameters are:

- "DC Cut-off Frequency": this specifies the -3 dB point (in Hertz) for the initial high-pass filter;
- "Interstage Cut-off Frequency": this specifies the -3 dB point (in Hertz) for the first integrator output high-pass filter;
- "Output Cut-off Frequency": this specifies the -3 dB (in Hertz) point for the second integrator output high-pass filter;
- "Configuration Mode", which configures how many elements of the chain are used. The options are:
  - 0 Apply only the initial DC filter;
  - 1 Apply DC filter and first integrator;
  - 2 Apply DC filter, first integrator and interstage HPF;
  - 3 Apply DC filter, first integrator, interstage HPF and second integrator; and
  - 4 Apply DC filter, first integrator, interstage HPF, second integrator and second output HPF.

## Minimus, Minimus+, Fortimus, Certimus

Status Network Setup Power Trigger **Data Stream** Data Record Transforms Storage Logout Help

System type: Minimus | Host label: Support | Host name: MIN-C555 (10.10.0.13) | Serial number: 50517

Data Stream			
Display Streams	All	transform	Try to NOT change any SEED Location
Reboot		Disable All Streams	Reset All Settings
0XCHN0	200 Hz	Transforms Disabled	<input type="checkbox"/> DG.TEST.00   HDF
0ACCZ0	200 Hz	Double Integration	<input type="checkbox"/> DG.TEST.00   HHZ
			Display On Page: Sensor0
The "Reset All Settings" button will ALSO affect settings on other pages			
		<a href="#">RESP file 5</a>	
		<a href="#">RESP file 7</a>	

Status Network Setup Power Trigger Data Stream Data Record **Transforms** Storage Logout Help

System type: Minimus | Host label: Support | Host name: MIN-C555 (10.10.0.13) | Serial number: 50517

Configure Transforms			
0ACCZ0			
Selected Transform	Double Integration	Parameter Source	Default Parameters
			Save Parameters
DC Cut-off Frequency	0.5	Interstage Cut-off Frequency	0.003
		Output Cut-off Frequency	0.0015
			Configuration Mode: 4

0 = DC filter output  
 1 = DC HPF + 1st integration  
 2 = DC HPF + 1st integration + HPF  
 3 = ... + 2nd integration  
 4 = ... + 2nd integration + HPF

### 2.8.9 EEW CAP Parameters – Observer

When an EEW trigger occurs (or is simulated – see below), the peak ground motion values (Peak Ground Acceleration (PGA), Peak Ground Velocity (PGV) and Peak Ground Displacement (PGD)) are calculated and automatically recorded over the selected time-window and subsequently transmitted as a CAP message (see Section 2.9.3 for more details). This transform allows the operator to directly observe the acceleration, velocity and displacement output on the real-time streams. It is available for use with both velocity and acceleration input signals.

 **Note:** The EEW parameter transform can work as an observer: doesn't necessarily modify the data streams on which it is applied.

The implementation of the transform differs, depending on whether the input stream represents velocity or acceleration data.

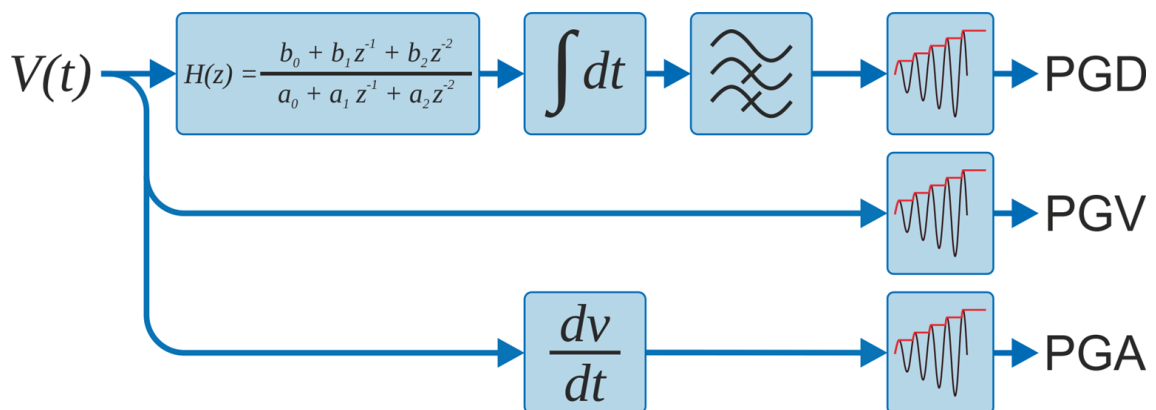

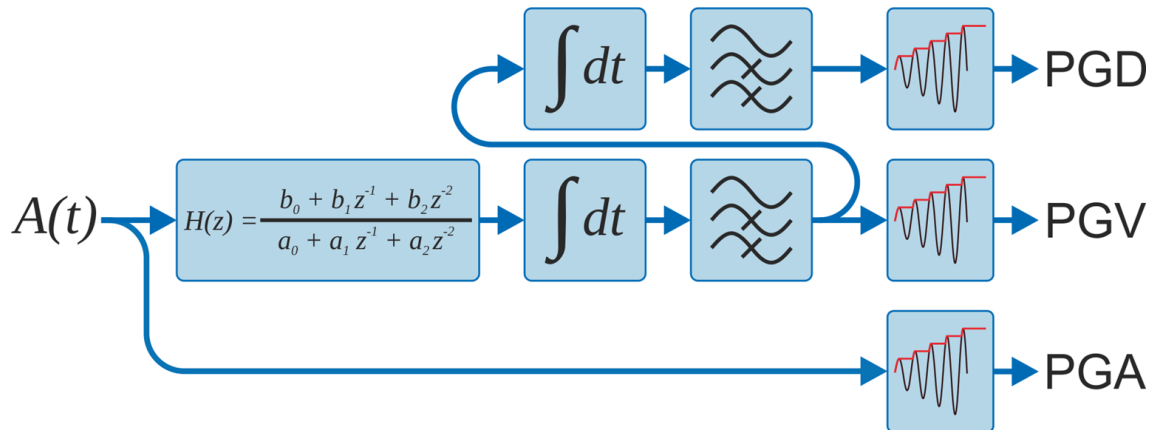

The high-pass filters are implemented using an LPF and a subtracter, as described in Section 2.8.4.

The configurable parameters are:

- "DC Cut-off Frequency": this specifies the -3 dB point (in Hertz) for the initial high-pass filter;
- "Interstage Cut-off Frequency": this specifies the -3 dB point (in Hertz) for the first integrator output high-pass filter. This is only used when the input signal is acceleration;
- "Output Cut-off Frequency": this specifies the -3 dB (in Hertz) point for the sole (velocity input) or final (acceleration input) integrator output high-pass filter;
- "Window time": this specifies the duration, in seconds, of the time-window over which the peak values are reported;
- "Preview Mode": the values to be shown in the output stream:
  - 0 unmodified original stream (acceleration or velocity);
  - 1 acceleration;
  - 2 velocity; or
  - 3 displacement.



**Note:** Güralp recommend using the integration (Section 2.8.7) and double integration (Section 2.8.8) transforms to test the filter parameters, because the effect of the parameters will then be clearly visible in the transformed streams. Once suitable parameters have been determined, they can be copied to the "EEW CAP Parameter – Observer" transform.

## Minimus, Minimus+, Fortimus, Certimus

Status Network Setup Power Trigger **Data Stream** Data Record Transforms Storage Logout Help

System type: Minimus | Host label: Support | Host name: MIN-C555 (10.10.0.13) | Serial number: 50517

Data Stream			
Display Streams	All	Transform	Try to NOT change any SEED Location
Reboot		Disable All Streams	Reset All Settings
The "Reset All Settings" button will ALSO affect settings on other pages			
0XCHN0	200 Hz	Transforms Disabled	<input type="checkbox"/> DG.TEST,00   HDF
0ACCZ0	200 Hz	EEW Parameters Observer	<input type="checkbox"/> DG.TEST,00   HHZ
		<a href="#">RESP file 5</a>	<a href="#">RESP file 7</a>

Status Network Setup Power Trigger Data Stream Data Record **Transforms** Storage Logout Help

System type: Minimus | Host label: NO LABEL | Host name: MIN-C555 (10.10.0.10) | Serial number: 00C555

Configure Transforms			
0ACCZ0			
Selected Transform	EEW Parameters - Observer		Parameter Source: Default Parameters
Save Parameters			
DC Cut-off Frequency	0.5	Interstage Cut-off Frequency	0.003
Output Cut-off Frequency	0.0015	Window Time (seconds)	3
Preview Mode	0		

0 = No preview  
 1 = View acceleration in stream  
 2 = View velocity in stream  
 3 = View displacement in stream.

### 2.8.10 STA/LTA Ratio

The Earthquake Early Warning system (EEW) compares the ratio of a short-term average (STA) to a long-term average (LTA) in order to detect a "trigger" conditions. For more information see Section 2.9.1.1.

This transform is included to help determine parameters for configuring the EEW system. It does not affect the operation of the EEW system in any way. The transform calculates the ratio between the result of the Short Term Average filter and the Long Term Average filter. The input signal is passed through a high-pass filter which removes any DC offset.



The configurable parameters are:

- "DC Frequency (Hz)": this specifies the corner frequency (-3 dB point) in Hertz for the initial high-pass filter;
- "LTA Period (seconds)": this is the Short Term Average filter time period (the reciprocal of the corner frequency);
- "STA Period (seconds)": this is the Long Term Average filter time period (the reciprocal of the corner frequency);

The high-pass filter is implemented using an LPF and a subtractor, as described in Section 2.8.4.

## Minimus, Minimus+, Fortimus, Certimus

Status Network Setup Power Trigger **Data Stream** Data Record Transforms Storage Logout Help

System type: Minimus | Host label: SUPRT-MIN | Host name: MIN-C555 (10.10.0.13) | Serial number: 50517

Data Stream			
Display Streams: All	Transform	Try to NOT change any SECD Location	Display On Page: Sensor 0
<input type="button" value="Reboot"/>	<input type="button" value="Disable All Streams"/>	<input type="button" value="Reset All Settings"/>	The "Reset All Settings" button will ALSO affect settings on other pages
0AUX00	200 Hz	Transforms Disabled	<input type="checkbox"/> DG.TEST,00 HDF HDF <a href="#">RESP file 5</a>
0ACC00	200 Hz	STA/LTA Ratio	<input type="checkbox"/> DG.TEST,00 HHZ HNZ <a href="#">RESP file 7</a>

Status Network Setup Power Trigger Data Stream **Transforms** Storage Logout Help

System type: Minimus | Host label: SUPRT-MIN | Host name: MIN-C555 (10.10.0.13) | Serial number: 50517

Configure Transforms			
0ACC00			
Selected Transform	STA/LTA Ratio	Parameter Source: Default Parameters	<input type="button" value="Save Parameters"/>
DC coefficient: 0.001	LTA coefficient: 0.005	STA coefficient: 0.1	

### 2.8.11 Rotation (Triplet)

This transform rotates three velocity/acceleration seismic components in space. Rotations are represented by unit quaternions (in preference to the more usual Euler angles: yaw, pitch and roll) because they are unambiguous and avoid the problem of gimbal lock.

**Note:** The rotation transform can only be applied if the transform is enabled on all three velocity/acceleration components of a single instrument at the same sample rate.

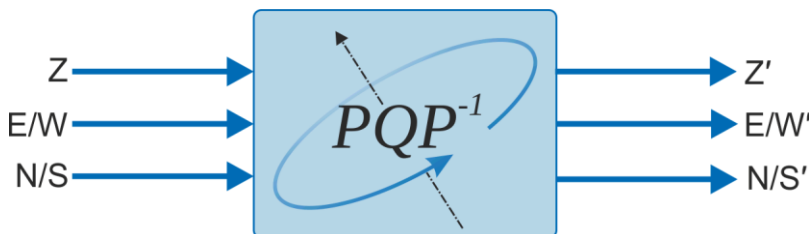

Any rotation in three-dimensional space can be represented as a combination of a unit three-dimensional vector,  $\vec{u}$ , which specifies the axis (and sense) of the rotation, and a scalar angle,  $\theta$ , which specifies the amount of rotation

Güralp follows a North, East, Up convention when describing sensor orientation. Using this convention, we can represent  $\vec{u}$  as  $[u,v,w]$  and use Pauli's extension to Euler's formula:

$$q = \cos\left(\frac{\theta}{2}\right) + (ui + vj + wk) \sin\left(\frac{\theta}{2}\right)$$

to form a quaternion:  $q \equiv [a, b, c, d]$  where:

$$a = \cos\left(\frac{\theta}{2}\right), b = \sin\left(\frac{\theta}{2}\right)u, c = \sin\left(\frac{\theta}{2}\right)v \text{ and } d = \sin\left(\frac{\theta}{2}\right)w$$

For example, a perfectly-oriented sensor has a (null) rotation of  $[1,0,0,0]$ , where the sensor's Z, N and E axes align with the North, East and Up global axes.



A rotation of

$$\left[ \frac{1}{\sqrt{2}}, \frac{1}{\sqrt{2}}, 0, 0 \right]$$

represents a sensor that has been rotated 90° about its *x* axis to align the sensor's Z, N and E axes with global North, Down and East respectively.



**Note:** Clockwise rotations, when looking along an axis, are denoted as positive. This is generally known as the "right-hand rule" because, if you point your right thumb along the (directed) axis, your fingers will curl in a clockwise direction about it.

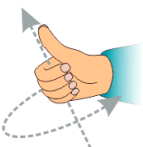

In the degenerate case of a simple rotation about a vertical axis (commonly used to correct data from a misaligned borehole instrument), the axis of rotation is vertical, so our unit vector is [0,0,1] (following the "North, East, Up" convention). To rotate by  $\theta$  (where positive  $\theta$  is clockwise when looking upwards), our quaternion should be:

$$q = \cos\left(\frac{\theta}{2}\right) + (0i + 0j + 1k) \sin\left(\frac{\theta}{2}\right) \equiv \left[ \cos\left(\frac{\theta}{2}\right), 0, 0, \sin\left(\frac{\theta}{2}\right) \right]$$

As a final check, note that

$$a^2 + b^2 + c^2 + d^2 = \cos^2\left(\frac{\theta}{2}\right) + 0^2 + 0^2 + \sin^2\left(\frac{\theta}{2}\right) = 1$$

which satisfies our requirement for a unit quaternion. The parameters to enter in the Configure Transforms fields are, therefore:

**Scalar**  $\Rightarrow \cos\left(\frac{\theta}{2}\right)$ , **X**  $\Rightarrow 0$ , **Y**  $\Rightarrow 0$  and **Z**  $\Rightarrow \sin\left(\frac{\theta}{2}\right)$

[Status](#) [Network](#) [Setup](#) [Power](#) [Trigger](#) [Data Stream](#) [Data Record](#) [Transforms](#) [Storage](#) [Logout](#) [Help](#)

System type: Minimus | Host label: Support | Host name: MIN-C555 (10.10.0.13) | Serial number: 50517

Data Stream			
Display Streams	Transform	Try to NOT change any SEED Location	Display On Page
<input type="button" value="Reboot"/>	<input type="button" value="Disable All Streams"/>	<input type="button" value="Reset All Settings"/>	The "Reset All Settings" button will ALSO affect settings on other pages
0AUX0 200 Hz	Transforms Disabled	<input type="checkbox"/> DG.TEST,00 HDF	<a href="#">RESP file 5</a>
0ACCZ0 200 Hz	Rotation (Triplet)	<input type="checkbox"/> DG.TEST,00 HDF	<a href="#">RESP file 7</a>
0ACCN0 200 Hz	Rotation (Triplet)	<input type="checkbox"/> DG.TEST,00 HDF	<a href="#">RESP file 8</a>
0ACCE0 200 Hz	Rotation (Triplet)	<input type="checkbox"/> DG.TEST,00 HDF	<a href="#">RESP file 11</a>

[Status](#) [Network](#) [Setup](#) [Power](#) [Trigger](#) [Data Stream](#) [Data Record](#) [Transforms](#) [Storage](#) [Logout](#) [Help](#)

System type: Minimus | Host label: Support | Host name: MIN-C555 (10.10.0.13) | Serial number: 50517

Configure Transforms			
0ACCZ0 / 0ACCN0 / 0ACCE0			
Selected Transform	Rotation (Triplet)	Parameter Source	Default Parameters
Scalar	1 X 0 Y	Y	0 Z 0

## 2.8.12 QSCD Sender (Triplet)

The QSCD protocol (Quick Seismic Characteristic Data) transmits values computed from the three triaxial streams of an instrument. One packet is transmitted every second so the number of samples in each packet is equal to the sample rate of the three input streams.

QSCD calculations are implemented using transforms and configured via the Data Stream tab of the Minimus web page. The three input channels must all be configured with the QSCD (triplet) transform. (The transform is disabled if the sample rates of the input streams do not match.)

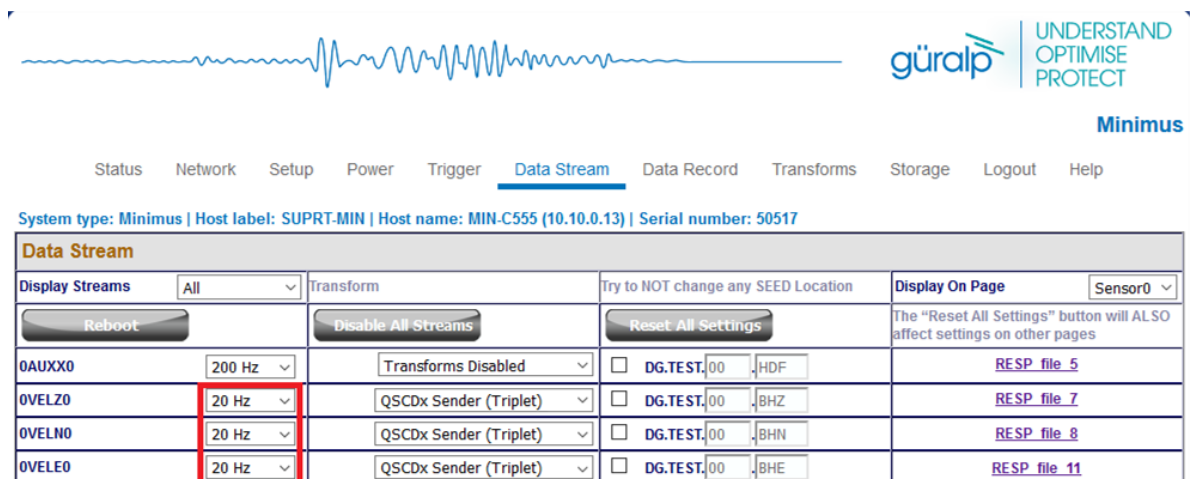

The screenshot shows the 'Data Stream' configuration page for a Minimus system. The system type is Minimus, host label is SUPRT-MIN, host name is MIN-C555 (10.10.0.13), and serial number is 50517. The 'Data Stream' tab is active, showing a table of channels and their configurations. The 'Transform' column for channels OVELZ0, OVELN0, and OVELE0 is set to 'QSCDx Sender (Triplet)'. The 'Period length' for these channels is set to 20 Hz. The 'Display On Page' column shows the sensor location and the corresponding RESP file.

Channel	Period length	Transform	Try to NOT change any SEED Location	Display On Page
0AUXX0	200 Hz	Transforms Disabled	<input type="checkbox"/> DG.TEST,00 .HDF	RESP file 5
OVELZ0	20 Hz	QSCDx Sender (Triplet)	<input type="checkbox"/> DG.TEST,00 .BHZ	RESP file 7
OVELN0	20 Hz	QSCDx Sender (Triplet)	<input type="checkbox"/> DG.TEST,00 .BHN	RESP file 8
OVELE0	20 Hz	QSCDx Sender (Triplet)	<input type="checkbox"/> DG.TEST,00 .BHE	RESP file 11

In the "Transform Parameters" tab, the parameter "Period length" configures the number of samples to include in a QSCD packet. For example, QSCD20 requires the sample rate of the streams to be 20 samples per second so the "Period length" must be set to 20 (samples), to send a packet every second.

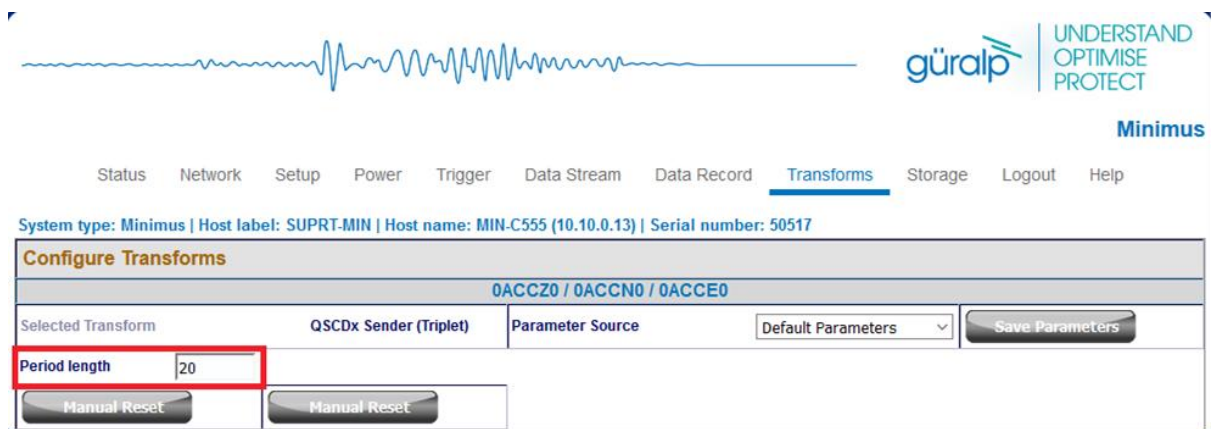

The screenshot shows the 'Configure Transforms' page for a Minimus system. The system type is Minimus, host label is SUPRT-MIN, host name is MIN-C555 (10.10.0.13), and serial number is 50517. The 'Transforms' tab is active, showing the configuration for the selected transform 'QSCDx Sender (Triplet)'. The 'Period length' parameter is set to 20. The 'Parameter Source' is set to 'Default Parameters'.

Selected Transform	Parameter Source
QSCDx Sender (Triplet)	Default Parameters

Period length: 20

## 2.8.13 MMA Logger

The MMA logger transform is a function that periodically calculates and logs Maximum Minimum and mean (Average) values over a selected window of data.

The two configurable parameters are:

## Minimus, Minimus+, Fortimus, Certimus

- "Short Period Length": this is the length of time between logging events expressed in samples, e.g. 200 samples when applied to a tap configured at 100sps produces an MMA calculation and logging every 2 seconds.
- "Window Length in Short Periods": is the length of window over which the Max, Min and Average values are calculated, in terms of number of short periods.

[Status](#) [Network](#) [Setup](#) [Power](#) [Trigger](#) [Data Stream](#) [Data Record](#) [Transforms](#) [Storage](#) [Logout](#) [Help](#)

System type: Minimus | Host label: SUPRT-MIN | Host name: MIN-C555 (10.10.0.13) | Serial number: 50517

Data Stream			
Display Streams	All	Transform	Try to NOT change any SCED Location
<input type="button" value="Reboot"/>		<input type="button" value="Disable All Streams"/>	
		<input type="button" value="Reset All Settings"/>	
The "Reset All Settings" button will ALSO affect settings on other pages			
0AUX00	200 Hz	Transforms Disabled	<input type="checkbox"/> DG.TEST,00 HDF HDF
0ACC00	200 Hz	MMA Logger	<input type="checkbox"/> DG.TEST,00 HHZ HNZ
		<a href="#">RESP file 5</a>	
		<a href="#">RESP file 7</a>	

[Status](#) [Network](#) [Setup](#) [Power](#) [Trigger](#) [Data Stream](#) [Data Record](#) [Transforms](#) [Storage](#) [Logout](#) [Help](#)

System type: Minimus | Host label: SUPRT-MIN | Host name: MIN-C555 (10.10.0.13) | Serial number: 50517

Configure Transforms	
0ACC00	
Selected Transform	MMA Logger
Parameter Source	Default Parameters
<input type="button" value="Save Parameters"/>	
Short Period Length	1000
Window Length in Short Periods	5

## 2.9 Triggers

The “Trigger” tab is dedicated to Earthquake Early Warning settings. These are disabled by default because of the amount of processing resource – and hence, power – consumed by triggering calculations.

The Triggers section of the web page enables the user to configure the triggering system. The trigger Sources should be configured firstly because different configuration options are displayed for different source types. Once the source-specific settings are configured, the scores and destinations should be specified. Destinations can be shared between sources, allowing the creation of networks (directed graphs) of systems for distributed event detection.

The heart of the Earthquake Early Warning subsystem are the triggering algorithms: an STA/LTA (Short-Time-Average divided by Long-Time-Average) and a threshold algorithm.

The STA/LTA algorithm continuously calculates the average values of the absolute amplitude of a seismic signal in two simultaneous moving-time windows. The short time average (STA) is sensitive to seismic events while the long-time average (LTA) provides information about the current amplitude of seismic background noise at the site. When the ratio of STA to LTA exceeds a pre-set threshold value an event is “declared”.

The threshold algorithm, instead, declares the presence of an event when the raw data from the input passes above or below a pre-set threshold value.

### 2.9.1 Trigger Sources

The available sources for the trigger are listed below, along with the configurable fields available in each case.

- 1 **1<sup>st</sup>/2<sup>nd</sup>/3<sup>rd</sup>/4<sup>th</sup> Remote Source:** This setting is used for multiple-source triggering networks. The sources specified here are other Minimus based instruments, specified by the I.P. addresses configured in the “Remote Inputs” section:

Triggers configuration			
Source	1st Remote Source	Score	100
Destination	Disabled		

The configurable fields in these cases are:

- Score: this assigns a value to the trigger. The score value is used when assessing multiple-source triggers simultaneously, where the total score value of all triggers can be set as a threshold variable of a destination. This value is ignored when a trigger is not configured to use multiple sources.
- Destination: this drop-down menu specifies the destination for the trigger. See Section 2.9.2 for more information.
- $n^{\text{th}}$  Address: is the I.P. address of the remote source, *e.g.* another Minimus.

Sources	
Remote Inputs	
1st Address	<input type="text"/>

- 2 **1<sup>st</sup>/2<sup>nd</sup>/3<sup>rd</sup>/4<sup>th</sup> I/O Expander Input:** Select this option to use inputs from a connected Minimus 8 channel I/O Expander Module.

Triggers configuration					
Source	1st I/O Expander Input ▾	Score	100	Destination	Disabled ▾

The configurable fields in these cases are:

- Score: this assigns a value to the trigger. The score value is used when assessing multiple-source triggers simultaneously, where the total score value of all triggers can be set as a threshold variable of a destination. This value is ignored when a trigger is not configured to use multiple sources.
  - Destination: this drop-down menu specifies the destination for the trigger. See Section 2.9.2 for more information.
- 3 **Tap Trigger *N*:** Chose between seismic or auxiliary Minimus channels among any of the active taps in the “Data Stream” and “Data Record” tabs.

Triggers configuration					
Source	Tap Trigger A [0ACCZ0] ▾	Score	100	Destination	Disabled ▾



**Note:** Tap trigger is only an option if you’ve populated the Source field “Tap Trigger A” with a sensor and trigger value

The configurable fields for Tap Triggers are:

- Score: this assigns a value to the trigger. The score value is used when assessing multiple-source triggers simultaneously, where the total score value of all triggers can be set as a threshold variable of a destination. This value is ignored when a trigger is not configured to use multiple sources.
- Destination: this drop-down menu specifies the destination for the trigger. See Section 2.9.2 for more information.
- Sources: Sensor number: this drop-down menu selects which sensor’s streams to use as input for the trigger algorithm.
- Sources: Tap: this drop-down menu allows selection of the stream to use as input for the trigger algorithm. The choice is between single taps, *e.g. OVELZ0*, or triplets, *e.g. First Seismo Triplet*.
- Sources: Trigger type: this drop-down menu allows the use of either **STA/LTA** or **Threshold** algorithm.

### 2.9.1.1 STA/LTA Algorithm

Averages of the modulus of signal amplitude are computed over two user defined time periods, a short time average (STA) and a long time average (LTA), and the ratio of the two at each sample point is computed (STA/LTA). If this ratio exceeds a user-defined threshold, then a trigger is declared, and the system remains in a triggered state until the ratio falls below the defined threshold. The STA/LTA algorithm is used to remove the effects of varying background noise.

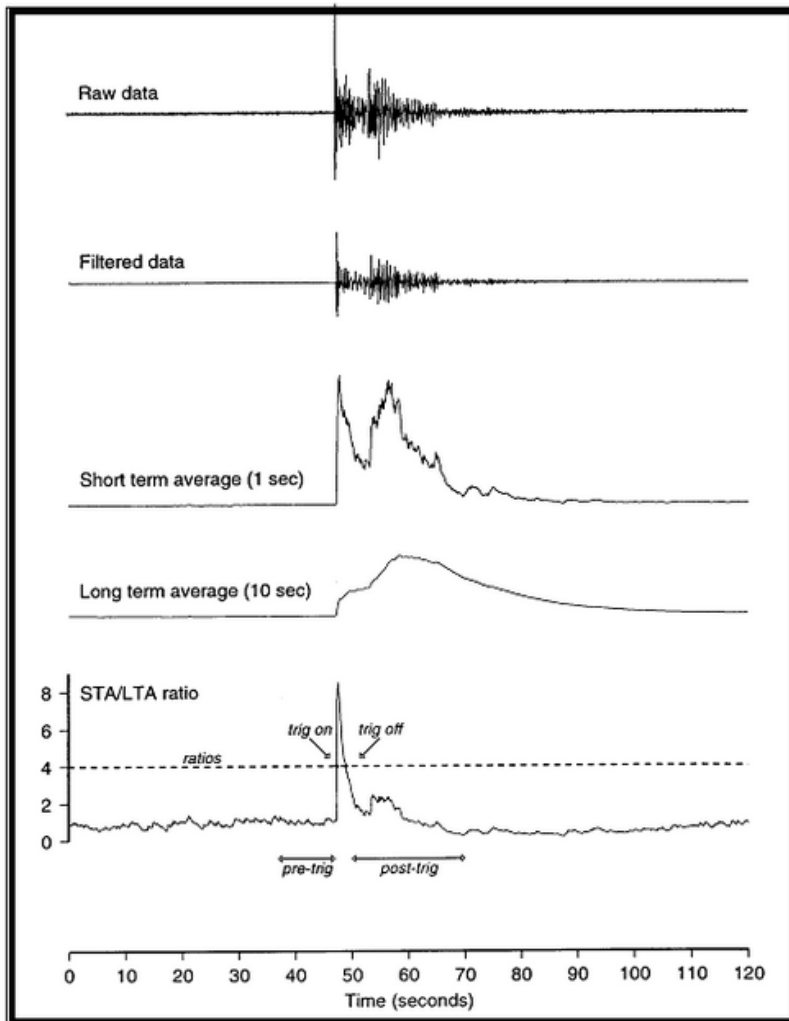

The purpose of taking a short term average, rather than triggering on signal amplitude directly, is to reduce the probability of triggering on spurious spikes or short duration transients, and to introduce some element of frequency selectivity into the triggering process. As a rule of thumb, the short term average should be set to the dominant frequency of the events the trigger is designed to catch.

The purpose of the long term average is to provide a measure of the variation in the background seismic noise, so it should be set to some value longer than the period of the lowest frequency seismic signal of interest. Obviously there is some element of trade-off in setting a value for the trigger ratio. Too high a value will result in events being missed, while too low a value will result in spurious non-seismic noise triggering the system

Minimus, Minimus+, Fortimus, Certimus

producing false alarms. Determining an appropriate value in any given situation which maximises the number of seismic events detected while minimising the number of false alarms is a matter of experimentation.

The STA/LTA trigger algorithm includes the configuration of the following parameters:

Sources			
Remote Inputs			
Tap Triggers			
Tap Trigger A	Sensor 0	0ACCZ0	STA/LTA Trigger
DC Frequency (Hz)	0.04	LTA Period (Seconds)	12
		STA Period (Seconds)	0.5
		Trigger Threshold	12
Event Window (Seconds)	5	Initial Timeout (Seconds)	10
		<input type="checkbox"/> Preview in Stream	

- “DC Frequency”: initial AC coupling HPF corner frequency;
- “LTA Period”: Long Term Average filter time period (1/corner frequency);
- “STA Period”: Short Term Average filter time period (1/corner frequency);
- “Trigger Threshold”: STA/LTA ratio level at which a trigger occurs;
- “Event Window”: After an event has been detected, subsequent crossing of the STA/LTA ratio threshold within the defined event window are treated as part of the same event and, therefore, not considered as a new trigger event;
- “Initial Timeout”: period of inactivity after the trigger function is initialised or changed to avoid false triggers.
- The “Preview in Stream” box enables the live streams to output the calculated trigger thresholds, *i.e.* the STA/LTA ratio. When a single stream is selected as source, the calculated STA/LTA ratio is shown in place of the original data.



Minimus, Minimus+, Fortimus, Certimus

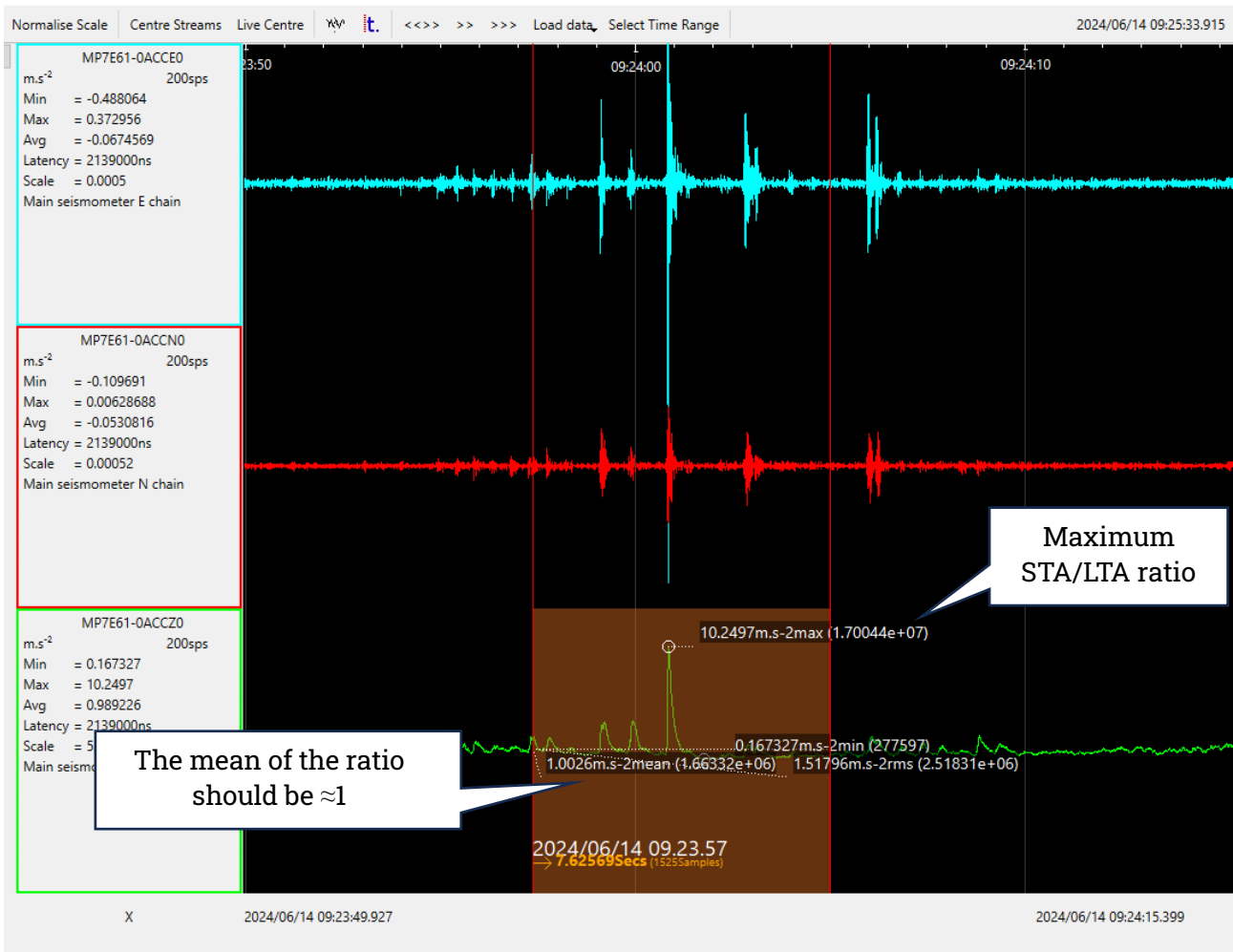

When a triplet is selected as source, "3D or Z & NE" parameters are used to choose what type of preview to visualise.

For STA/LTA ratio trigger algorithm:

Sources					
Local Tap Triggers					
Tap Trigger A	Sensor 0	First Seismo Triplet	STA/LTA Trigger		
DC Frequency (Hz)	0.04	LTA Period (Seconds)	12	STA Period (Seconds)	0.5
Event Window (Seconds)	5	Initial Timeout (Seconds)	10	3D or Z & NE	1
				Trigger Threshold	12
				<input checked="" type="checkbox"/>	Preview in Stream

1 = Trigger off of the 3D resultant of Z, N & E together.  
 0 = Trigger off of the Z component and the 2D resultant of the horizontal N & E components separately.

- 0 shows the STA/LTA ratio calculated on a 2D resultant vector of N and E components. The 2D STA/LTA ratio is shown in place of original E/W component. The Z component also shows the STA/LTA ratio calculated instead of the original seismic data. The N/S component shows normal seismic output.
- 1 shows the STA/LTA ratio calculated on 3D resultant vector of Z, N and E components. The STA/LTA ratio is shown on E/W component. Z and N/S components show their normal seismic output.

## 2.9.1.2 Threshold Algorithm

The threshold algorithm declares the presence of an event when the raw data input passes above or below a pre-set threshold value.



**Note:** Since the threshold value has to be expressed in physical units, *e.g.* m/s<sup>2</sup>, the right instrument response parameters have to be entered in the calibration editor when an analogue instrument (*e.g.* Fortis) is connected to a Minimus. Please see Section 2.7.1.5 for more details.

The threshold trigger algorithm includes the configuration of the following parameters:

Sources			
Remote Inputs			
Tap Triggers			
Tap Trigger A	Sensor 0	0ACCZ0	Threshold Trigger
Absolute Mode	0	Low/High Mode	1
		Threshold	10
		Timeout	10
Hysteresis Percentage	10	<input type="checkbox"/> Preview in Stream	

- “Absolute Mode”: specifies if the threshold must act on the magnitude of the signal with a sign (+,-), options include:
  - 0 Real Values: the trigger will act on the standard response of the signal (positive or negative) against the given threshold
  - 1 Absolute Values: Will take the absolute value (only positive) of the signal to compare against the threshold;
  - 2 Absolute Values DC Filter: Takes the absolute value of the source signal minus the DC offset (long term average), before comparing against the trigger threshold, only works for non-triplet sources;
- “Low/High Mode”: defines whether the threshold is exceeded when the signal passes below it, or above it, the option are:
  - 0 Triggers when the signal passes **below** the threshold, Low Mode;
  - 1 Triggers when the signal passes **above** the threshold, High Mode
- “Threshold”: value of the threshold expressed in a physical unit, this option will be interpreted based on the type of sensor selected for the source tap, *e.g.* m/s<sup>2</sup>;
- “Timeout”: specifies the time to wait (in seconds), after crossing the threshold, before accepting a new event;
- “Hysteresis Percentage”: defines the hysteresis point in terms of percentage of the threshold value, below or above the threshold. The hysteresis point is below the threshold for High Mode and above the threshold for Low Mode.
- “Preview in Stream”: When “Absolute Mode” is set to 1 and a single stream is selected as a source, enabling the “Preview in Stream” box shows within the live stream (from Discovery’s main menu, right click the instrument,

highlight “Live View” and select "GDI") the absolute value of the original signal. When “Absolute Mode” is set to 2 and a single stream is selected as a source, enabling the “Preview in Stream” box shows within the live stream the absolute value of the original signal after the removal of the DC Offset (long term average).

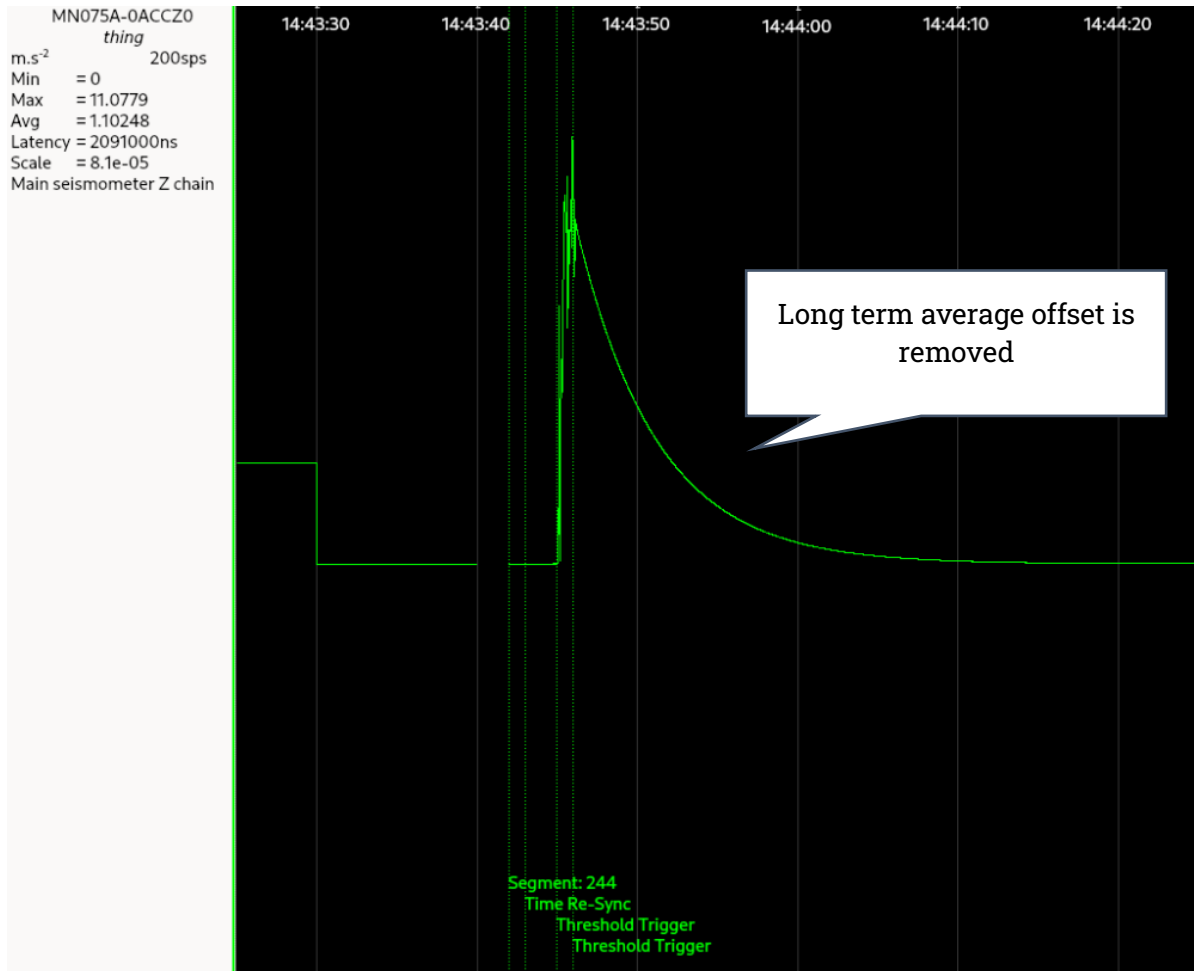

When a triplet is selected as source, “3D or Z & NE” parameters are used to choose what type of preview to visualise.

For the Threshold trigger algorithm:

Sources					
Local Tap Triggers					
Tap Trigger A		Sensor 0	First Seismo Triplet	Threshold Trigger	
Absolute Mode	0	Low/High Mode	1	Threshold	10
Hysteresis Percentage	10	3D or Z & NE	1	<input checked="" type="checkbox"/> Preview in Stream	

1 = Trigger off of the 3D resultant of Z, N & E together.  
 0 = Trigger off of the Z component and the 2D resultant of the horizontal N & E components separately.

- 0 shows the 2D resultant vector of N and E components. The 2D resultant is shown in place of E/W component. Z and N/S components show normal seismic output.

- 1 shows the 3D resultant vector of Z, N and E components. 3D resultant is shown in place of E/W component. Z and N/S components show normal seismic output.

## 2.9.2 Trigger Destinations

The options available from the various Destination fields are:

- **1<sup>st</sup>/2<sup>nd</sup>/3<sup>rd</sup>/4<sup>th</sup> CAP receiver:** When a trigger is declared, the system will issue messages using the Common Alerting Protocol (for the full specification of this protocol, please refer to <http://docs.oasis-open.org/emergency/cap/v1.2/CAP-v1.2-os.html>).

This selection points to which of the four available CAP receivers the trigger information will be sent to, the CAP receivers can be configured as detailed below.

Triggers configuration							
Source	1st Remote Source	Score	100	Destination	1st CAP receiver		
Destinations							
Common Alerting Protocol Messaging							
1st CAP Address	52.34.40.123	1st CAP Port	11789	Total Score	300	1st CAP Threshold	200
1st CAP Msg scope	Restricted	1st CAP Recipient	eeew@guralp.com	1st CAP Inhibit Timeout	10	1st CAP Acceptance Window	1

Various parameters control how the CAP message is created:

- $n^{\text{th}}$  CAP Address: the I.P. address or Hostname of the CAP receiver;
- $n^{\text{th}}$  CAP Port: the UDP port on which the CAP receiver is listening;
- Total Score: this is an information field, it displays an automatically-calculated total of the scores from all of the input sources that specify this as a destination;
- $n^{\text{th}}$  CAP Threshold: The CAP threshold is used when multiple input sources subscribe to this destination, the score of each trigger is summed up and once it is equal to or greater than the threshold score, the events will be sent. Otherwise trigger threshold from the source configuration is used.
- $n^{\text{th}}$  CAP Msg scope: This value is copied to the "scope" field of the CAP message, it allows the designation of CAP message to be Public, Private or Restricted;
  - Public: The CAP Receiver can send alerts to anyone
  - Restricted: The CAP Receiver is configured with a code to identify the groups it can send the alerts to
  - Private: The  $n^{\text{th}}$  CAP Recipient will be used as the only address the receiver can forward the alert to,
- $n^{\text{th}}$  CAP Recipient: this value is copied to the "addresses" field of the CAP message, it is only required when the " $n^{\text{th}}$  CAP Msg scope" is set to "Private";

## Minimus, Minimus+, Fortimus, Certimus

- $n^{\text{th}}$  CAP Inhibit Timeout: Is the time the Minimus waits before sending a new CAP message if a new event is detected after a previous CAP message was sent;
- $n^{\text{th}}$  CAP Acceptance Window: Subsequent source triggers for a given destination are counted towards the cumulative score if they arrive within this window;

Common Alerting Protocol			
CAP Msg Expiry	<input type="text" value="300"/> seconds	CAP Msg Web URL	<input type="text" value="https://cap-validator.appspot.com"/>
		CAP Msg HMAC Key	<input type="text" value="secret"/>

- CAP Msg Expiry: This parameter determines the value used to populate the optional “expires” field in the CAP message. If required, it should be specified in seconds.
- CAP Msg Web URL: This parameter determines the value used to populate the optional “web” field in the CAP message. It should be a full, absolute URL for an HTML page or other text resource with additional or reference information regarding this alert.
- CAP Msg HMAC Key: A shared key used for signing the CAP message. All CAP messages generated by Minimus are signed. The user should set this key to a private value. The HMAC (High-based Message Authentication Code) digest can then be used to both authenticate the sender and validate the contents of CAP messages by anyone who is privy to the shared key. This prevents the generation of false, malicious CAP messages by a third party.



**Note:** EEW parameters (PGA, PGV and PGD values) are sent in the CAP message’s body only if the “EEW parameter – Observer” transform is enabled on the source taps (see Section 2.8.9).



**Note:** Güralp Discovery software includes a CAP (Common Alerting Protocol) receiver. For detailed information about the Discovery CAP receiver, please refer to Discovery’s manual ([MAN-DIS-0001](#)).

- **1<sup>st</sup>-8<sup>th</sup> I/O Expander Output:** Select this value to use outputs from a connected Minimus 8 channel I/O Expander Module. See MAN-MIN-1001 for more details.

Triggers configuration			
Source	<input type="text" value="Tap Trigger A [0VELZ0]"/> ▾	Score	<input type="text" value="100"/>
		Destination	<input type="text" value="1st I/O Expander Output"/> ▾

Destinations			
Relay Outputs			
1st Hold Time	<input type="text" value="1"/>	1st Total Score	<input type="text" value="300"/>
		1st Score Threshold	<input type="text" value="200"/>
1st Inhibit Timeout	<input type="text" value="10"/>	1st Acceptance Window	<input type="text" value="1"/>

Various parameters control how the I/O Expander behaves:

- $n^{\text{th}}$  Hold Time: Is the relay switch timeout in seconds. If configured to 0, no timeout is used, otherwise the relay will be released after a specified number of seconds;

## Minimus, Minimus+, Fortimus, Certimus

- $n^{\text{th}}$  Total Score: This is an information field, it displays an automatically-calculated total of the scores from all of the input sources that specify this as a destination;
- $n^{\text{th}}$  Score Threshold: this threshold is used when multiple input sources subscribe to this destination, the score of each trigger is summed up and once it is equal to or greater than the threshold score, the commands will be sent. Otherwise trigger threshold from the source configuration is used.
- $n^{\text{th}}$  Inhibit Timeout: Is the time in seconds the Minimus waits before sending a new command to the I/O Expander, if a new event is detected after a previous command was sent;
- $n^{\text{th}}$  Acceptance Window: Subsequent source triggers for a given destination are counted towards the cumulative score if they arrive within this window.
- **1<sup>st</sup>/2<sup>nd</sup>/3<sup>rd</sup>/4<sup>th</sup> Remote receiver:** This setting is used to consolidate multiple triggers to a single Minimus for it to act as a hub for triggering activity. The destinations specified here require a networked Minimus based instruments, specified by the I.P. address configured in the “Remote Outputs” section:

Triggers configuration				
Source	Tap Trigger A [0VELZ0] ▾	Score	100	Destination 1st Remote receiver ▾

Destinations				
Remote Outputs				
1st Address		1st Total Score	300	1st Score Threshold
				0
1st Inhibit Timeout	10			
1st Acceptance Window	1			

- $n^{\text{th}}$  Address: The I.P. address of the networked Minimus;
- $n^{\text{th}}$  Total Score: This is an information field, it displays an automatically-calculated total of the scores from all of the input sources that specify this destination;
- $n^{\text{th}}$  Score Threshold: : this threshold is used when multiple input sources subscribe to this destination, the score of each trigger is summed up and once it is equal to or greater than the threshold score, the message will be sent. Otherwise trigger threshold from the source configuration is used.
- $n^{\text{th}}$  CAP Inhibit Timeout: Is the time the Minimus waits before sending a new message, if a new event is detected after a previous message was sent;
- $n^{\text{th}}$  Acceptance Window: Subsequent source triggers for a given destination are counted towards the cumulative score if they arrive within this window.

---

### 2.9.3 CAP Receiver

Güralp Discovery includes a CAP (Common Alerting Protocol) receiver. It listens on a specified UDP port for incoming CAP messages. When one arrives, it is displayed and plotted on a map. In addition, the receiver can open a TCP connection to the cloud-based registry server and display CAP messages that have been sent to the registry server.



**Note:** For more details about the Discovery built-in receiver and configuration of the registry server, please see Discovery's manual [MAN-DIS-0001](#).

---

## 2.9.4 How to Configure a Trigger Step-By-Step

In this section is an example of how to configure a trigger. Specifically, the following steps allow you to configure an STA/LTA trigger on the vertical component of the main seismic channel (0ACCZ0) when the ratio exceeds 12. A CAP message is also sent to Discovery's CAP receiver (with the instance of Discovery open on a laptop with an I.P. address 10.20.1.69) when an event is detected. The CAP message contains information about the PGA (Peak Ground Acceleration), PGV(Peak Ground Velocity) and PGD(Peak Ground Displacement). A similar procedure should be followed to configure triggers with different characteristics.

1. From the "Data Stream" tab enable the transform for channel 0ACCZ0. Once the page refreshes, from the same drop-down menu, choose "EEW CAP parameters - Observer" to receive PGA, PGV and PGD values in the CAP message. Reboot the device for the transform to be applied;
2. From the tab "Transform Parameters" configure the parameters for the transform. See Section 2.8.9 for more details;







System type: Minimus | Host label: SUPRT-MIN-TEST | Host name: MIN-A555 (10.20.1.82) | Serial number: 0A555

Data Stream			
<b>Disable All Streams</b>	<b>Restore default</b>	The "Disable All" and "Restore default" button will ALSO affect settings of any other sensors	<b>Reboot</b>
<b>Copy to Data Record</b>	"Copy to Data Record" will apply settings from this page to recording configuration of all of the sensors.		
Display Streams	Enabled Only	<input checked="" type="checkbox"/> Apply configuration for tap groups	Display On Page <span>Sensor 0</span>
Channels configuration			
Channel sampling rate	Data transform	SEED name - please use check-box to modify the default	RESPonse file - if available
<b>Seismic channels</b>			
0ACCZ0	200 Hz	EEW CAP Parameters - Observer	<input type="checkbox"/> DG.0A555.0J .HNZ <a href="#">RESP file 7</a>
0ACCN0	200 Hz	Pass-through	<input type="checkbox"/> DG.0A555.0J .HNN <a href="#">RESP file 11</a>
0ACCE0	200 Hz	2nd Order Biquad Filter	<input type="checkbox"/> DG.0A555.0J .HNE <a href="#">RESP file 15</a>
0AUXX0	200 Hz	1st Order LPF	<input type="checkbox"/> DG.0A555.0J .HDF <a href="#">RESP file 5</a>
		1st Order HPF	
		Band/Notch Filter (1st Order)	
		STA/LTA Ratio	
<b>mic channels</b>			
0ACCZC	125 Hz	Differentiation	<input type="checkbox"/> DG.0A555.0N .HNZ <a href="#">RESP file 19</a>
		Integration	
0ACCNC	125 Hz	Double Integration	<input type="checkbox"/> DG.0A555.0N .HNN <a href="#">RESP file 21</a>
		Rotation (Triplet)	
0ACCEC	125 Hz	JMA Intensity	<input type="checkbox"/> DG.0A555.0N .HNE <a href="#">RESP file 23</a>
		EEW CAP Parameters - Observer	
<b>annels</b>			
0TMPA0	10 Hz	QSCDx Sender (Triplet) - Observer	<input type="checkbox"/> DG.0A555.9S .BKO <a href="#">RESP file 635</a>
		MMA Logger - Observer	
0VINP0	10 Hz	Disable Transforms for this tap (reboot)	<input type="checkbox"/> DG.0A555.1 .BQV <a href="#">RESP file 631</a>
0HUMA0	10 Hz	Transforms Disabled for this tap	<input type="checkbox"/> DG.0A555.9Q .BIO <a href="#">RESP file 633</a>
0CVDAC	10 Hz	Transforms Disabled for this tap	<input type="checkbox"/> DG.0A555.9K .BED

- From the "Trigger" tab, under "Sources" → "Tap Trigger A" use the drop-down menu to change from "No Trigger" to "Sensor 0";
- Use the drop-down menu to change from "Select Tap" to 0ACCZ0;
- Use the drop-down menu to change from "No Trigger" to "STA/LTA Trigger";
- Configure the fields "DC Frequency", "LTA period", "STA period", "Trigger threshold", "Event Window", "Initial Timeout". In this example, "Trigger threshold" will be set to 12;
- If you want to visualise these settings in the live data viewer, tick the box "Preview in Stream" (from Discovery's main menu, right click the instrument, highlight "Live View" and select "GDI") the live value of the STA/LTA will show instead of the normal 0ACCZ0 stream,

UNDERSTAND  
OPTIMISE  
PROTECT

Minimus

Status Network Setup **Trigger** Data Stream Data Record Storage Logout Help

System type: Minimus | Host label: SUPRT-MIN-TEST | Host name: MIN-A555 (10.20.1.82) | Serial number: 0A555

**Triggers**

Reboot

**Seismic Events Table**

Download Settings:	Seconds Pre	<input type="text" value="10"/>	Seconds Post	<input type="text" value="10"/>	<input checked="" type="checkbox"/> Download Z,N,E Triplet
Time of Event Duration	Trigger Function (Tap)	Max Signal Diff	Download Source Tap	Download	

No Seismic Events to Display

**Triggers configuration**

Source

**Sources**

Local Tap Triggers

Tap Trigger A	Sensor 0	<input type="text" value="0ACCZ0"/>	STA/LTA Trigger
DC Frequency (Hz)	<input type="text" value="0.04"/>	LTA Period (Seconds)	<input type="text" value="12"/>
Event Window (Seconds)	<input type="text" value="5"/>	Initial Timeout (Seconds)	<input type="text" value="10"/>
STA Period (Seconds)	<input type="text" value="0.5"/>	Preview in Stream	<input checked="" type="checkbox"/>
Trigger Threshold	<input type="text" value="12"/>	Tap Trigger B	<input type="text" value="No Trigger"/>

**Common Alerting Protocol**

CAP Msg Expiry	<input type="text" value="300"/> seconds	CAP Msg Web URL	<input type="text" value="https://cap-validator.appspot.com"/>	CAP Msg HMAC Key	<input type="text" value="secret"/>
----------------	------------------------------------------	-----------------	----------------------------------------------------------------	------------------	-------------------------------------

- Under "Triggers configuration" use the drop-down menu to change from "Disabled" to "Tap Trigger A [0ACCZ0]";
- Use the drop-down menu to change the destination to "1<sup>st</sup> CAP Receiver". A section towards the bottom of the page named "Destination" will now appear;
- Type the I.P. address of the destination of the CAP message (in this example, 10.20.1.69, for you this will be the IP address of a device with Discovery installed or your own personal CAP Receiver) in the field "1<sup>st</sup> CAP Address". "1<sup>st</sup> CAP port" is set to 11789 by default, but this can be changed (if using the CAP receiver built into Discovery, it needs to match the port specified in Discovery);



System type: Minimus | Host label: SUPRT-MIN-TEST | Host name: MIN-A555 (10.20.1.82) | Serial number: 0A555

Triggers			
<input type="button" value="Reboot"/>			
Seismic Events Table			
Download Settings:	Seconds Pre <input type="text" value="10"/>	Seconds Post <input type="text" value="10"/>	<input checked="" type="checkbox"/> Download Z,N,E Triplet
Time of Event Duration	Trigger Function (Tap) Max Signal Diff	Download Source Tap	Download
No Seismic Events to Display			
Triggers configuration			
Source <input type="text" value="Tap Trigger A [0ACCZ0]"/>	Score <input type="text" value="100"/>	Destination <input type="text" value="1st CAP receiver"/>	
Source <input type="text" value="Disabled"/>			
Sources			
Local Tap Triggers			
<b>Tap Trigger A</b>	Sensor 0 <input type="text" value="0ACCZ0"/>	<input type="text" value="0ACCZ0"/>	STA/LTA Trigger <input type="text" value=""/>
DC Frequency (Hz) <input type="text" value="0.04"/>	LTA Period (Seconds) <input type="text" value="12"/>	STA Period (Seconds) <input type="text" value="0.5"/>	Trigger Threshold <input type="text" value="12"/>
Event Window (Seconds) <input type="text" value="5"/>	Initial Timeout (Seconds) <input type="text" value="10"/>	<input checked="" type="checkbox"/> Preview in Stream	
<b>Tap Trigger B</b>	No Trigger <input type="text" value=""/>		
Destinations			
Common Alerting Protocol Messaging			
1st CAP Address <input type="text" value="10.20.1.69"/>	1st CAP Port <input type="text" value="11789"/>	Total Score <input type="text" value="100"/>	1st CAP Threshold <input type="text" value="0"/>
1st CAP Msg scope <input type="text" value="Restricted"/>	1st CAP Recipient <input type="text" value="eew@guralp.com"/>	1st CAP Inhibit Timeout <input type="text" value="10"/>	1st CAP Acceptance Window <input type="text" value="1"/>
Common Alerting Protocol			
CAP Msg Expiry <input type="text" value="300"/> seconds	CAP Msg Web URL <input type="text" value="https://cap-validator.appspot.com"/>	CAP Msg HMAC Key <input type="text" value="secret"/>	

## 2.9.5 Seismic Event Table

The Minimus can generate a “Seismic Event Table”. This lists the events detected by the STA/LTA or Threshold trigger enabled on taps. It contains information about the time when the event occurred, the duration, the channel that generated the trigger and the peak magnitude of the event. The seismic data before, during and after the event are saved in miniSEED format and can be downloaded using links within the table. Events will populate the table only once they have an end point.

The table is located at the bottom of the “Trigger” tab in the Minimus web page.

Seismic Events Table			
Download Settings:	Seconds Pre	10	Seconds Post
			10
			<input checked="" type="checkbox"/> Download Z,N,E Triplet
Time of Event Duration	Trigger Function (Tap) Peak Magnitude (Time)	Download Source Tap	Download
Thu Aug 2 12:21:17 2018 < 1 second	STA/LTA Trigger (0AXL10) 0.50187 m.s	S0AccZA	<a href="#">Request Event Data</a>
Thu Aug 2 12:21:17 2018 < 1 second	STA/LTA Trigger (0AXL10) 0.58626 m.s	S0AccZA	<a href="#">Request Event Data</a>
Thu Aug 2 12:21:17 2018 < 1 second	STA/LTA Trigger (0AXL10) 0.27047 m.s	S0AccZA	<a href="#">Request Event Data</a>
Thu Aug 2 12:20:46 2018 < 1 second	STA/LTA Trigger (0AXL20) 0.08352 m.s	S0AccNA	<a href="#">Request Event Data</a>
Thu Aug 2 12:20:46 2018 < 1 second	STA/LTA Trigger (0AXL10) 0.74786 m.s	S0AccZA	<a href="#">Request Event Data</a>
Thu Aug 2 12:20:46 2018 < 1 second	STA/LTA Trigger (0AXL20) 0.14463 m.s	S0AccNA	<a href="#">Request Event Data</a>
Wed Aug 1 09:27:20 2018 < 1 second	STA/LTA Trigger (0AXL20) 0.2666 m.s	S0AccNA	<a href="#">Request Event Data</a>

The Minimus allows the download of event data in miniSEED format in a time range that is user selectable. The user can select how many seconds before and after the event detection to include in the miniSEED file.



Download Settings:	Seconds Pre	10	Seconds Post	10	<input checked="" type="checkbox"/> Download Z,N,E Triplet
--------------------	-------------	----	--------------	----	------------------------------------------------------------

The event table shows which of the components has caused the trigger and the user can chose to either download data related to that single component by deselecting the option “Download Z,N,E Triplet” or download data for all three components by leaving the option enabled.

Download Settings:	Seconds Pre	10	Seconds Post	10	<input type="checkbox"/> Download Z,N,E Triplet
--------------------	-------------	----	--------------	----	-------------------------------------------------

The last column of the table contains links to downloaded and saved miniSEED files related to each event.

Time of Event Duration	Trigger Function (Tap) Peak Magnitude (Time)	Download Source Tap	Download
Thu Aug 2 12:21:17 2018 < 1 second	STA/LTA Trigger (0AXL10) 0.50187 m.s	S0AccZA	<a href="#">Request Event Data</a>
Thu Aug 2 12:21:17 2018 < 1 second	STA/LTA Trigger (0AXL10) 0.58626 m.s	S0AccZA	<a href="#">Request Event Data</a>
Thu Aug 2 12:21:17 2018 < 1 second	STA/LTA Trigger (0AXL10) 0.27047 m.s	S0AccZA	<a href="#">Request Event Data</a>
Thu Aug 2 12:20:46 2018 < 1 second	STA/LTA Trigger (0AXL20) 0.08352 m.s	S0AccNA	<a href="#">Request Event Data</a>
Thu Aug 2 12:20:46 2018 < 1 second	STA/LTA Trigger (0AXL10) 0.74786 m.s	S0AccZA	<a href="#">Request Event Data</a>
Thu Aug 2 12:20:46 2018 < 1 second	STA/LTA Trigger (0AXL20) 0.14463 m.s	S0AccNA	<a href="#">Request Event Data</a>
Wed Aug 1 09:27:20 2018 < 1 second	STA/LTA Trigger (0AXL20) 0.2666 m.s	S0AccNA	<a href="#">Request Event Data</a>

 **Note:** The links produce downloadable miniSEED files if and only if the requested data is available in the microSD card. This depends on last flushing time and selected post event time. Use the  button in the Storage tab to copy most recent data into the microSD cards (see Section 2.3.4).

## 2.9.6 Improving Latency

### 2.9.6.1 Low Latency Mode

In the Setup tab, the “Low Latency Mode” drop-down menu controls the processor workload that affects the power-consumption of Minimus. This control can be used to prioritise power-consumption at the expense of latency, to balance the two or to optimise latency regardless of the power consumption. Three settings are available:

- Minimum Power ⇒ slow processing / higher latency / low power consumption;
- Balanced ⇒ medium processing / medium latency / medium power consumption;
- Minimum latency ⇒ fast processing / lower latency / high power consumption;

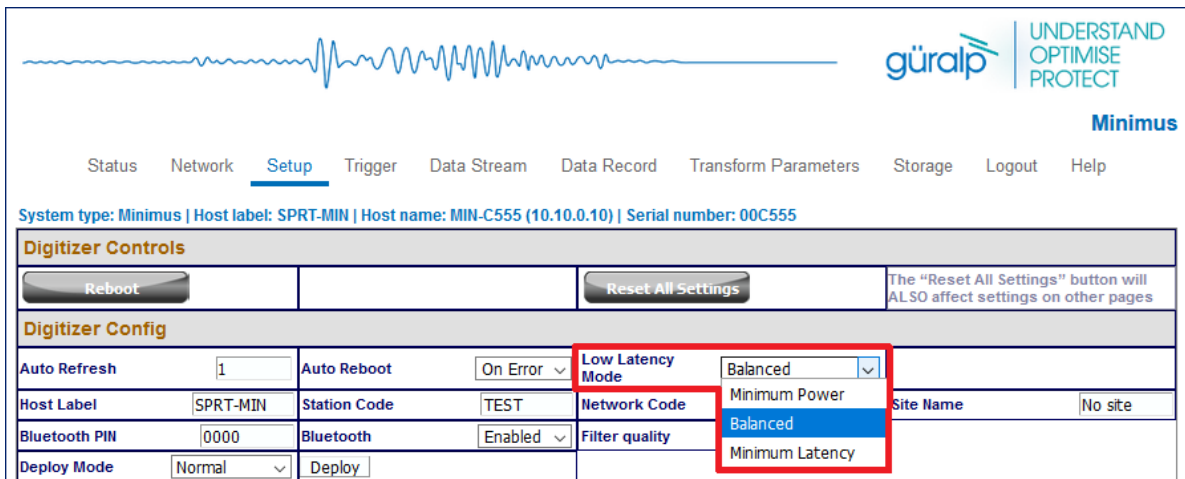

The screenshot shows the Minimus web interface. At the top, there is a logo for 'güralp' and the text 'UNDERSTAND OPTIMISE PROTECT'. Below the logo is the 'Minimus' title. The navigation menu includes 'Status', 'Network', 'Setup' (which is active), 'Trigger', 'Data Stream', 'Data Record', 'Transform Parameters', 'Storage', 'Logout', and 'Help'. The system information bar shows: 'System type: Minimus | Host label: SPRT-MIN | Host name: MIN-C555 (10.10.0.10) | Serial number: 00C555'. The 'Digitizer Controls' section contains 'Reboot' and 'Reset All Settings' buttons. The 'Digitizer Config' section includes various settings: 'Auto Refresh' (1), 'Auto Reboot' (On Error), 'Low Latency Mode' (Balanced), 'Host Label' (SPRT-MIN), 'Station Code' (TEST), 'Network Code', 'Bluetooth PIN' (0000), 'Bluetooth' (Enabled), 'Filter quality', 'Deploy Mode' (Normal), and 'Deploy'. The 'Low Latency Mode' dropdown menu is highlighted with a red box, showing the options: 'Minimum Power', 'Balanced', and 'Minimum Latency'.

### 2.9.6.2 EEW Packets

Typically, each miniSEED packet is transmitted once it is completely populated with data, with a fixed packed size of 512 Bytes. To improve latency when streaming data using the

SEEDlink protocol, a modified version of SEEDlink allows you to transmit packets which are not complete. The rate at which the miniSEED packets must be transmitted can be specified from the Network tab ("Send SeedLink EEW Packet Every", in deciseconds). The modified SEEDlink is only available for the low latency seismic channels (i.e. the main seismic channels generated with causal low latency filters).

For more information about the modified version of SEEDlink and how to use it, please see Section 2.4.3.

---

### 2.9.6.3 Considerations About Low Latency Channels

The Minimus performs an initial data sampling at a very high rate. Then, it down-samples the sensor data in a process called *decimation* to achieve the target value of the output (in Hz or seconds), where the maximum sample size gets divided by values of 2, 3, 4 or 5 to equal the sample rate value set for that channel. The higher the sample rate the more values will be stored within memory, impacting the overall capacity. However lower sample rates require larger time frames and more processing power which impacts the latency of the results within the Minimus.

Before each down-sampling stage, the high frequencies are removed using digital filters, to avoid aliasing. Digital filters can be *casual* (they only consider past samples to calculate the output value) or *acasual* (also consider future samples). The default filters on Minimus are *acasual*: they provide a more accurate transcription of the data but they can cause several seconds of additional latency. The low latency channels are specifically designed for EEW (Earthquake Early Warning) applications and use causal filters, which however distort the phase of incoming signal. Therefore, low latency channels are well suited for early warning systems, whilst the standard channels are better suited for identifying location and impact.

When discussing latency, unless specified, we are talking about the full stack of processes that occur from a sensor posting a value to the data packet being received by an end point. This is inclusive of network latency but worth noting that the choice of sensor output (in Hz or seconds) as discussed above, adds to this value. When designing a station it is recommended to take account of the bandwidth available for sending data as well as the output value of all sensors to calculate for a stable configuration.

## 2.10 Instrument's Metadata

Minimus provides metadata in three different formats: Dataless SEED volume, RESP files and StationXML files. The three sections that follow describe where to find them.

### 2.10.1 Dataless SEED Volume

MiniSEED files do not contain detailed station metadata, but they represent a collection of raw data records (time-series data). The metadata – including network and station information, such as responses of the instruments and digitisers - are encoded in a file called "Dataless SEED file" .

The Dataless SEED file can be found in the "Storage" tab of the Minimus' webpage under "Auxiliary files". To download it, just click on its filename.

Auxiliary files	
Filename	
DG_0E667.dataless	Dataless SEED file
fram.log	FRAM log file
Certis.xml	Certis StationXML
calvals.txt	SCREAM! calibration values
polezero.txt	SCREAM! zeros, poles and gains
calib.txt	Calibration text file
seedlink.log	Seedlink server log

The first component of the file name depends on the two-character Network code defined in the Setup tab, while the second contains the instrument's serial number. If, for example, the network code is DG and the Minimus' serial number is MIN-E667, the file is called DG\_0E667.dataless.

The Dataless SEED file is also available by direct URL. Simply type into a web browser the IP address of the Minimus followed by the Dataless SEED filename, for example:

[http://10.20.1.92/DG\\_0E667.dataless](http://10.20.1.92/DG_0E667.dataless)

You can also use the `wget` command from the command line to download the Dataless SEED volume from the URL above. The command would look something like this:

```
wget http://10.20.1.92/DG_0E667.dataless
```

The Dataless SEED file is generated from the RESP files for each channel (see next Section).

### 2.10.2 RESP File

The Dataless SEED file is created automatically by the Minimus and contains configuration data for all the available channels. The contents of the Dataless SEED file can be displayed in human-readable form for individual channels. These files are known

## Minimus, Minimus+, Fortimus, Certimus

as RESP, and they are accessible by clicking on the “RESP file” link of each channel in the “Data Stream” and “Data Record” tab of the Minimus web page interface.

The screenshot shows the Minimus web interface. At the top right, there is a logo for 'güralp' and the slogan 'UNDERSTAND OPTIMISE PROTECT'. Below the logo is the 'Minimus' brand name. The navigation menu includes 'Status', 'Network', 'Setup', 'Trigger', 'Data Stream' (which is the active tab), 'Data Record', 'Storage', 'Logout', and 'Help'. The system information bar displays: 'System type: Minimus | Host label: SPRT-MIN | Host name: MIN-C555 (10.10.0.10) | Serial number: 00C555'. The 'Data Stream' section contains several buttons: 'Disable All Streams', 'Restore default', 'Copy to Data Record', and 'Reboot'. A note states: 'The "Disable All" and "Restore default" button will ALSO affect settings of any other sensors'. Below the buttons, there are configuration options: 'Display Streams' set to 'All', a checked box for 'Apply configuration for tap groups', and 'Display On Page' set to 'Sensor 0'. The 'Channels configuration' section has a table with columns: 'Channel sampling rate', 'Data transform', 'SEED name - please use check-box to modify the default', and 'RESPONSE file - if available'. Underneath is a 'Seismic channels' table with four rows: 0AUXX0, 0VELZ0, 0VELN0, and 0VELE0. Each row has a '200 Hz' sampling rate, 'Transforms Disabled for this tap', a checked box for 'DG.TEST,00', and a 'RESPONSE file' link (e.g., 'RESP\_file\_5', 'RESP\_file\_7', 'RESP\_file\_11', 'RESP\_file\_15'). These links are highlighted with red boxes.

Clicking on a RESP file link produces a page like this:

```
#          << Guralp SEED response file builder v1.2-8615 >>
#
#          ===== CHANNEL RESPONSE DATA =====
B050F03   Station:      TEST
B050F16   Network:      DG
B052F03   Location:     OK
B052F04   Channel:      HNZ
B052F22   Start date:   2018,214,11:26:48
B052F23   End date:      No Ending Time
#
#          +-----+-----+-----+-----+
#          +          | Channel Sensitivity, TEST ch HNZ |          +
#          +-----+-----+-----+-----+
#
B058F03   Stage sequence number:      0
B058F04   Sensitivity:                2.131148E+05
B058F05   Frequency of sensitivity:   1.000000E+00 HZ
B058F06   Number of calibrations:     0
#
#          +-----+-----+-----+-----+
#          +          | Response (Poles & Zeros), TEST ch HNZ |          +
#          +-----+-----+-----+-----+
#
B053F03   Transfer function type:      A [Laplace Transform (Rad/sec)]
B053F04   Stage sequence number:      1
B053F05   Response in units lookup:    M/S**2 - Acceleration in Metres Per Second Squared
B053F06   Response out units lookup:    V - Volts
B053F07   A0 normalization factor:    3.022955E+12
B053F08   Normalization frequency:     1.000000E+00
```

Right-click anywhere and select “Back” to return to the Minimus’ web page interface.

To save a RESP file, right click on the “RESP file” link and select "Save Link":



## Minimus, Minimus+, Fortimus, Certimus

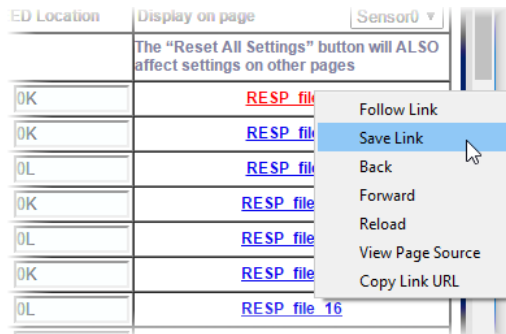

**Note:** RESP files are not available for channels that have a transform enabled, with the exception of the “EEW CAP Parameters – Observer” transform

In a similar way to the Dataless SEED files, the RESP files are also available by direct URL. Simply type in a web browser the IP address of the Minimus followed by the RESP filename, for example:

[http://10.20.1.92/RESP\\_file\\_7.txt](http://10.20.1.92/RESP_file_7.txt)

You can also use the `wget` command from the command line to download the RESP file from the URL above. The command would look something like this:

```
wget http://10.20.1.92/RESP_file_7.txt
```

### 2.10.3 Station XML File

Seismic metadata is also available in XML format. The XML file can be found in the “Storage” tab of the Minimus’ webpage as “Sensor0.xml”. To download it, check the tick-box and click on “Download selected files”.

<input type="checkbox"/>	<a href="#">status.log</a>	11869910	2024-09-05 09:23:05.000000000
<input type="checkbox"/>	<a href="#">system.log</a>	33825052	2024-09-05 09:28:19.000000000
<input type="checkbox"/>	<a href="#">init.log</a>	33554432	2024-08-31 07:05:58.000000000
<input checked="" type="checkbox"/>	<a href="#">Sensor0.xml</a>	1354917	2024-09-04 16:29:10.000000000
<input type="checkbox"/>	<a href="#">Sensor1.xml</a>	555723	2024-09-04 16:29:16.000000000
<input type="checkbox"/>	<a href="#">data.xml</a>	34059	2024-08-28 15:58:29.000000000
<input type="checkbox"/>	<a href="#">table_of_events.bin</a>	7168	2024-09-03 15:54:38.000000000

Also the XML files are available by direct URL. Simply type in a web browser the IP address of the Minimus followed by `/sd` and the XML filename, for example:

<http://10.20.1.92/sd/Sensor0.xml>

You can also use the `wget` command from the command line to download the XML file from the URL above. The command would look something like this:

```
wget http://10.20.1.92/sd/Sensor0.xml
```

An example XML file is shown in the figure below. Opening the XML file with a web browser allows you to view the structured data and expand/collapse blocks of information using the left-hand side angled arrows.

## Minimus, Minimus+, Fortimus, Certimus

← ↻ ⚠ Not secure | 10.20.1.92/sd/Sensor0.xml

This XML file does not appear to have any style information associated with it. The document tree is shown below.

```
<?xml version="1.0" encoding="UTF-8" standalone="1" ?>
<FDSNSTationXML xmlns="http://www.fdsn.org/xml/station/1" schemaVersion="1.1">
  <Source>Guralp Certimus</Source>
  <Created>2024-06-10T13:19:59Z</Created>
  <Network code="DG">
    <Station code="0E667">
      <Latitude>51.360699</Latitude>
      <Longitude>-1.163408</Longitude>
      <Elevation>111.900002</Elevation>
      <Site>
        <Name>No site</Name>
      </Site>
      <Equipment>
        <Type>Instrument</Type>
        <Description>Certimus</Description>
        <Manufacturer>Guralp Systems Limited</Manufacturer>
        <Model>Certimus</Model>
        <SerialNumber>E667</SerialNumber>
      </Equipment>
      <Channel code="BQV" locationCode="1">
        ...
      </Channel>
      <Channel code="BYP" locationCode="1">
        ...
      </Channel>
      <Channel code="BKO" locationCode="9J">
        ...
      </Channel>
      <Channel code="BKO" locationCode="9K">
        ...
      </Channel>
      <Channel code="AEO" locationCode="9M">
        ...
      </Channel>
      <Channel code="AEF" locationCode="9K">
        <Description>9K.AEF</Description>
        <Comment>
          <Value>S0/58983/1.5/0</Value>
        </Comment>
        <Latitude>51.360699</Latitude>
        <Longitude>-1.163408</Longitude>
        <Elevation>111.900002</Elevation>
        <Depth>0</Depth>
        <Azimuth>0</Azimuth>
        <Dip>0</Dip>
        <SampleRate>0</SampleRate>
      <Sensor>
        <Type>Certimus</Type>
        <Description>Certimus instrument</Description>
        <SerialNumber>E667</SerialNumber>
      </Sensor>
      <Response>
        <InstrumentSensitivity>
          <Value>1000000000.000000</Value>
          <Frequency>1.000000</Frequency>
          <InputUnits>
            <Name>s</Name>
            <Description>Time in Seconds</Description>
          </InputUnits>
          <OutputUnits>
            ...
          </OutputUnits>
        </InstrumentSensitivity>
      </Response>
    </Station>
  </Network>
</FDSNSTationXML>
```

## 2.11 Instrument's State of Health (SOH)

There are multiple ways of reporting and viewing the SOH data of an instrument. Many methods utilise the network features and can be scripted to pull the required data. SOH data is routinely written to the SD card at specific intervals and auxiliary channels can be enabled to capture or stream additional data. Below is a non-exhaustive list of the methods Güralp supports for viewing and extracting this data:

- Discovery: Güralp's proprietary tool to view and find networked devices, for a full list of features see the [Discovery Manual](#);
- HTTP Request: data can be accessed directly from a networked device with an HTTP command that specifies the path to the required data (e.g. <http://10.20.1.92/sd/status.log>)
- Wget command: a Linux supported method for downloading the data utilising the http format above (e.g. `wget http://10.20.1.92/sd/status.log`)
- User Generated Scripts: scripting languages such as bash or python can be used to automate the extraction and formatting of SOH data, scripts can also be set in discovery to allow ease of use for repetitive tasks ([Discovery Manual section 4.3.6](#))
- Serial/Debug Port: by connecting directly to the device the user can run commands that return status information, a full list of commands can be viewed by running the command "help";
- GüVü App: Güralp's android smartphone app that can report SOH data via Bluetooth;
- Auxiliary Channels: by filtering "Display Steams" by "All" on the "Data Record" or "Data Stream" tabs, "Auxilliary channels" can be viewed and enabled to record/stream SOH data for devices such as Voltage and Temperature
- Device LED: for a manual approach, the LED on many Güralp devices can be used to detect certain errors and interpret the SOH of the device.

---

### 2.11.1 LED Indicator

Minimus, Minimus+, Certimus and Fortimus have an LED indicator on the upper surface, which provides status and configuration information.

This information is encoded in sequences of coloured flashes. In general, red flashes indicate that initialisation is in progress or that the instrument has encountered a problem, green flashes indicate normal operation and blue flashes show trigger activity. The various codes are:



**One quick red flash followed by a one second pause:** the removable microSD card is present in the Minimus' external slot, but no fixed microSD card is present inside the Minimus.



**Two quick red flashes followed by a one second pause:** the fixed microSD card is present inside the Minimus but no removable microSD card is present in the Minimus' externally-accessible slot.



**Three quick red flashes following by a one second pause:** both microSD cards are present but either the GNSS receiver is disconnected or the GNSS lock is not sufficiently accurate.



**A green flash every four seconds:** this is the standard operating heartbeat. GNSS and both internal and external microSD cards are present, which indicates that the Minimus can be successfully deployed and left to record data.



**Note:** Depending on the digitiser's recent history, it can take up to ten minutes to reach this state after power-up.



**1 blue flash:** a trigger event has been detected.

---

## 2.11.2 Commands on the Debug RS232 Serial Port

The web page interface consists of named parameters with their respective values. There Name/Value pairs can be read and written from the serial debug port. This feature is offered specifically for the rarer applications where connectivity can only be provided by RS232 connection and not via the LAN (Local Area Network).

A group of commands are available under the name "var".

var ? - Lists available commands.

Some examples are reported below:

```
var get "Digitiser humidity" - Read contents of the named variable "Digitiser humidity"
```

```
var get "Integrator Z (0)" - Mass position of first sensor's vertical mass
```

```
var get "Temperature (0)" - Internal temperature of the device
```

---

## 2.11.3 HTTP State Of Health and Configuration Resources

Several files containing data can be downloaded from the Minimus' in-built WEB server when connected via LAN. These files can be used to check the running health of the Minimus as well as the configurations set for various components which could aid in troubleshooting problems or provide sanity checks for continued use.

---

### 2.11.3.1 ASCII Text Status

While normally status information gets written to the status.log file every 20 minutes, you can request a status.txt file to be produced at any moment, which shows the status of the

## Minimus, Minimus+, Fortimus, Certimus

system at the moment of the request. To perform this action from any browser, enter the IP address of the Minimus followed by “/status.txt”, for example:

<http://1.2.3.4/status.txt>

Which will provide the following output:

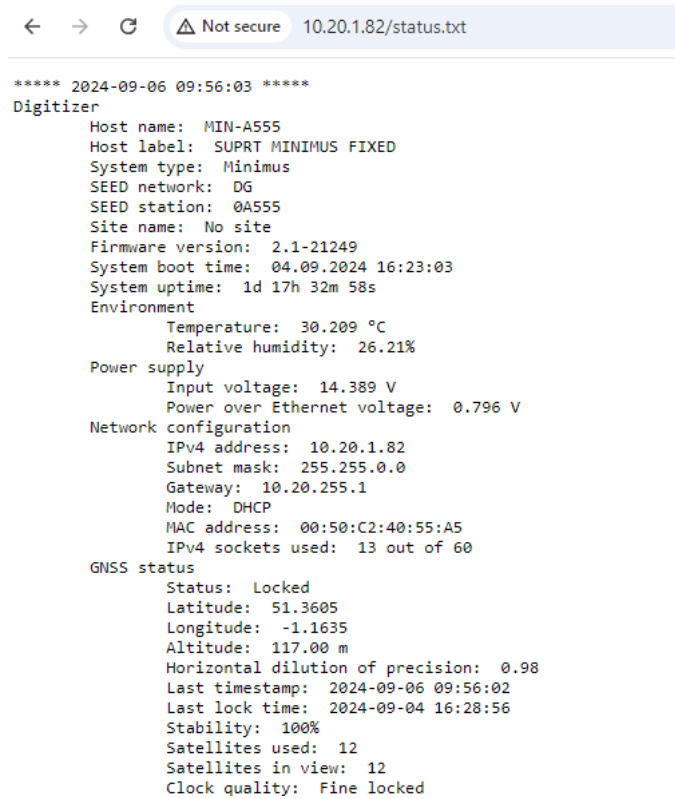

```
← → ↻ ⚠ Not secure 10.20.1.82/status.txt
***** 2024-09-06 09:56:03 *****
Digitizer
Host name: MIN-A555
Host label: SUPRT MINIMUS FIXED
System type: Minimus
SEED network: DG
SEED station: 0A555
Site name: No site
Firmware version: 2.1-21249
System boot time: 04.09.2024 16:23:03
System uptime: 1d 17h 32m 58s
Environment
  Temperature: 30.209 °C
  Relative humidity: 26.21%
Power supply
  Input voltage: 14.389 V
  Power over Ethernet voltage: 0.796 V
Network configuration
  IPv4 address: 10.20.1.82
  Subnet mask: 255.255.0.0
  Gateway: 10.20.255.1
  Mode: DHCP
  MAC address: 00:50:C2:40:55:A5
  IPv4 sockets used: 13 out of 60
GNSS status
  Status: Locked
  Latitude: 51.3605
  Longitude: -1.1635
  Altitude: 117.00 m
  Horizontal dilution of precision: 0.98
  Last timestamp: 2024-09-06 09:56:02
  Last lock time: 2024-09-04 16:28:56
  Stability: 100%
  Satellites used: 12
  Satellites in view: 12
  Clock quality: Fine locked
```

---

### 2.11.3.2 System Configuration

To access the configuration values for various components associated with the Minimus, from a browser enter the IP address of the device, followed by “/config.txt”, for example:

<http://1.2.3.4/config.txt>

This returns name/value pairs of WEB interface parameters.

## Minimus, Minimus+, Fortimus, Certimus

```
← → ↻ ⚠ Not secure 10.20.1.82/config.txt
7iip:Azimuth=0x00000000
7iip:Depth=0x00000000
8iip:Dip=0x00000000
8iip:Azimuth=0x00000000
8iip:Depth=0x00000000
0:Input gain=0x0001
0:Sensor type=0x0003
0:Fortis Range=0x0000
0:Mass Threshold=0x00000000
0:Scheduled calibration=0x00
0:Date and time=0x00000000
0:Repeat calibration every^seconds=0x00000000
0:Calibration duration^seconds=0x00000000
0:Lookup generator speed=0x0005
0:Lookup generator gain^%=0x42c80000
0:Sequence=
0:Mass Lock Polarity=0x0000
0:Mass Unlock Polarity=0x0000
0:Centring Polarity=0x0000
0:Cal Enable Polarity=0x0000
1:Input gain=0x0001
1:Sensor type=0x0003
1:Fortis Range=0x0000
1:Mass Threshold=0x00000000
1:Scheduled calibration=0x00
```

### 2.11.3.3 Instrument Response

To view the calibration values set for instruments connected to the Minimus, from a browser enter the IP address of the device, followed by “/calib.txt”, for example:

<http://1.2.3.4/calib.txt>

This returns the poles, zeros and gain values configured for instruments connected to the Minimus. Output values are shown in Hexadecimal format with 32-Bit single precision floats as specified by the IEE754 standard:

```
← → ↻ ⚠ Not secure 10.20.1.82/calib.txt
sensor 0, accelerometer, sensor ID =
sensor 0, axis 0, gain 0 = 3623BEE1
sensor 0, axis 0, gain 1 = FFFFFFFF
sensor 0, axis 0, gain 2 = 3E7CF6E5
sensor 0, axis 0, gain 3 = C47A0000
sensor 0, axis 0, gain 4 = FFFFFFFF
sensor 0, axis 0, gain 5 = FFFFFFFF
sensor 0, axis 0, gain 6 = FFFFFFFF
sensor 0, axis 0, gain 7 = FFFFFFFF
sensor 0, axis 0, pole 0 = C27C0000 + i*42B4C7AE
sensor 0, axis 0, pole 1 = C27C0000 + i*C2B4C7AE
sensor 0, axis 0, pole 2 = C351B333 + i*00000000
```

## 2.12 WiFi Connectivity

This chapter only applies to the Fortimus and Certimus that have built in WiFi capabilities.

WiFi can be used as the main networking method or configured so that it runs parallel to the ethernet configuration.

Enabling the WiFi will consume more power, which should be considered for sites that have a limited power supply.

1. To enable WiFi on a Fortimus or Certimus, first check that the external antenna has been attached and screwed into place.
2. Next load up the web page interface, log in as admin and navigate to the **Network** tab.
3. Scroll to the bottom of the page and locate the WiFi heading, tick the check box next to WiFi enabled to activate the WiFi component.
4. Click on the **Disconnect & Scan** button, then wait for 10 seconds before checking the drop-down box next to "Access Points" to find the network that you want to connect to.
5. After selecting your network, the "Requested AP" field should now be showing your chosen network, the next option to the right is the "Password" field, enter the password for your WiFi network here,
6. Finally click on **Connect** to confirm the details and test the connection, the "State" will show as "WiFi Connected" once the connection has been established.

If the "Auto Connect" option is enabled, then the WiFi will automatically try to connect when the device is rebooted.

## 2.13 Updating DIG Firmware

The DIG firmware is upgradeable. New releases appear regularly – either to add new features and, occasionally, to fix problems. Güralp recommends that the Minimus is regularly checked for availability of firmware updates and, *when convenient*, these updates should be installed.

The procedure below guarantees a straightforward upgrade and prevents any data loss or misconfiguration.

If you have any recorded data that you value, backup all files from Minimus microSD card:

1. Unplug the external microSD card from Minimus.
2. Plug the external microSD card into your PC.
3. Copy all files from the external microSD card into your PC.
4. Unplug the external microSD card from your PC.
5. Plug the external microSD card back into Minimus.

Once this is complete, to upgrade the Minimus:

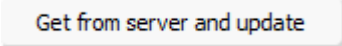
1. Run Discovery.
2. Right-click on the Minimus in Discovery main window and select “Firmware Update”.
3. In the “Firmware Update” tab, select “Güralp server – stable (online version: 2.1-\*\*\*\*)” to obtain the new firmware from the Internet via a local Ethernet connection. Click .



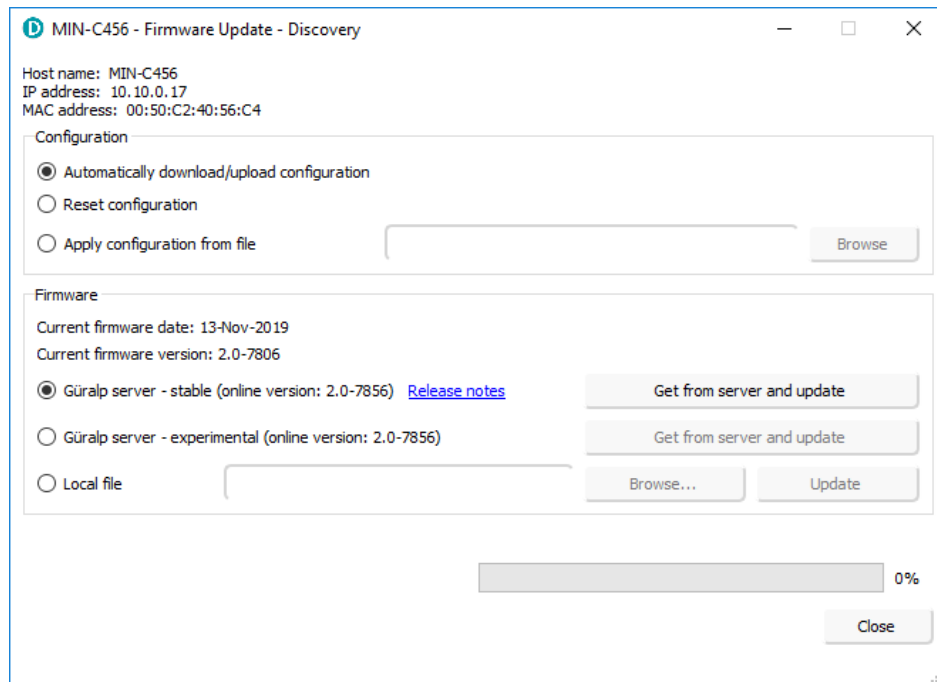

4. Discovery will ask you if you want to save the Firmware binary file for future use – click  for future use, *e.g.* update other systems offline using same firmware file. Otherwise, proceed with .
5. Discovery may ask to overwrite a temporary file on your PC – click  to allow it to do so.
6. Discovery will confirm through another dialogue box that the file download is complete. Click  to begin the firmware upload to the Minimus.
7. At the end of the uploading process, the dialogue box will ask to restart the Minimus. Click  to finalise the process.
8. A dialogue box will ask you if you want to upload the previous configuration. Click  to finalise the process.
9. When the configuration is uploaded, the Minimus needs to be restarted again. Confirm with  to the dialogue box.
10. The Minimus will re-boot and, during this process, the LED will rapidly flash white and power off for a few seconds.
11. Go to the “Storage” of the Minimus web page and Quick-format the microSD cards of your Minimus (for details, see Section 2.3.3.1).
12. Check that all indicators are green (*i.e.* nothing in red nor in yellow) in Discovery.
13. Go to the “Status” tab of the Minimus web page.
14. Check that your Minimus firmware version is as expected.

15. Check that nothing red or yellow shows up in the "Status" tab of the Minimus web page.



**Caution:** If updating from any release of v1.2 to v2.0, select the option "Güralp server – version 2.0-\*\*\*\* (online)" only. Do not use "Local file" option unless agreed case-by-case with [support@guralp.com](mailto:support@guralp.com).

MIN-AF55 - Firmware Update - Discovery

Host name: MIN-AF55  
IP address: 10.10.0.6  
MAC address: 00:50:C2:40:55:AF

Configuration

- Automatically download/upload configuration
- Reset configuration
- Apply configuration from file

Firmware

Current firmware date: 29-Apr-2019  
Current firmware version: 1.2-8707

- Güralp server - stable (online version: 1.2-8713) [Release notes](#)
- Güralp server - experimental (online version: 1.2-8713)
- Local file
- Güralp server - version 2.0-7856 (online)**

0%

If updating from any release of below v1.2, contact [support@guralp.com](mailto:support@guralp.com) before proceeding.

## 2.14 Import / Export an Existing Configuration

Updating the Minimus' firmware can, occasionally, cause loss of configuration. We recommend that you export and save the current configuration before proceeding with an upgrade. This operation can be done through Discovery by right-clicking on the digitiser in the list and selecting "System Configuration" from the context menu:

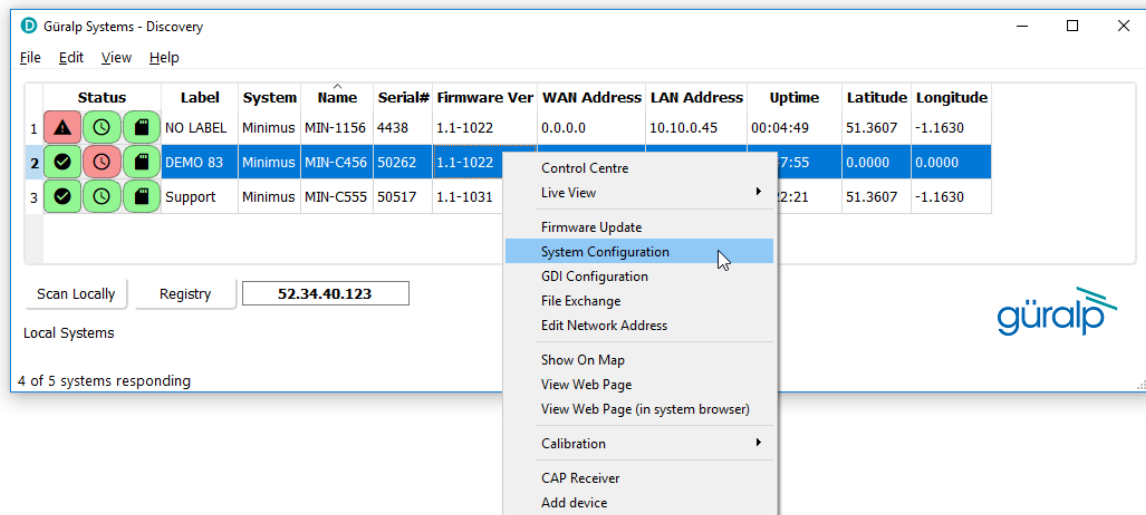

Select "Use configuration from one of the devices". If more than one device is available, select the one from which the configuration should be downloaded. Click the **Download configuration** button and browse to a suitable location (on your PC) into which to save the configuration file.

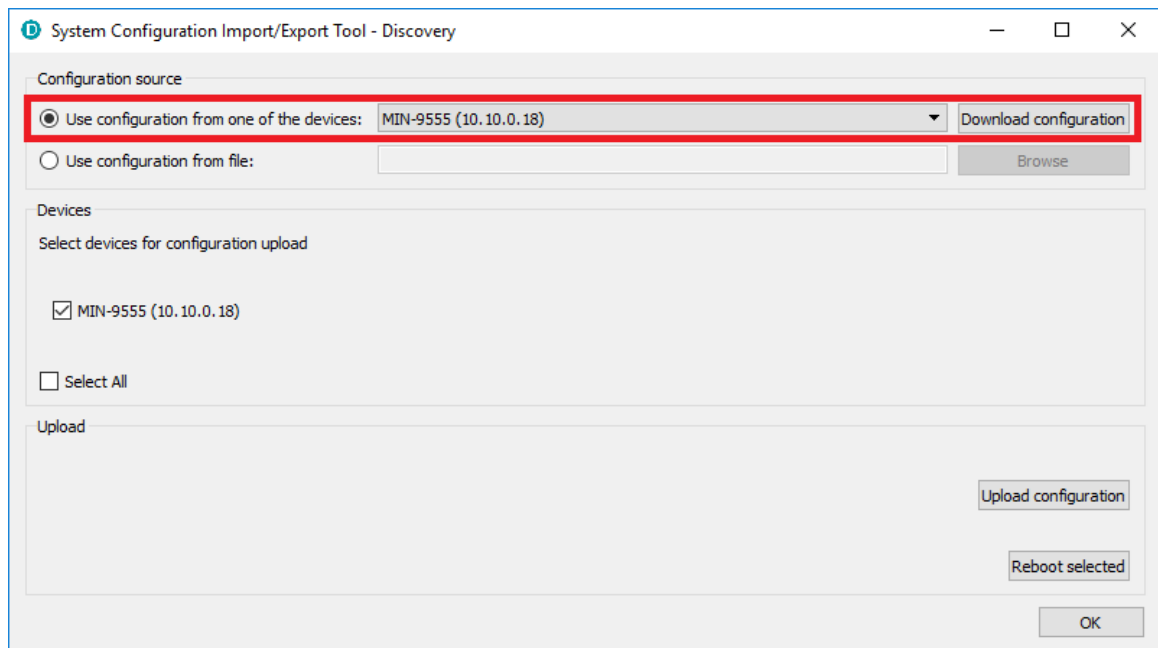

After the firmware update is successfully completed, the previous configuration can be imported, if required, by following the instructions below.

## Minimus, Minimus+, Fortimus, Certimus

Right-click on the digitiser's entry in the Discovery list and select "System Configuration" from the context menu. Select the "Use configuration from file" option.

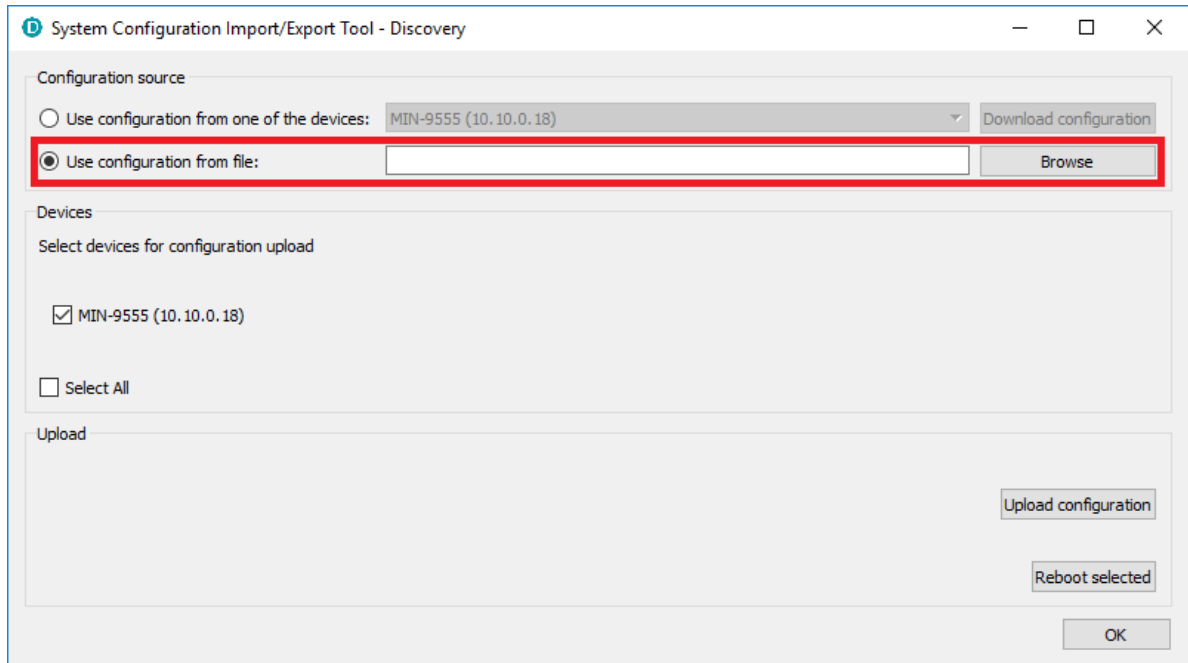

Select the configuration file from where it was saved in the File Explorer and confirm. Use the check-boxes to select the devices to which the configuration should be uploaded and click on the **Upload configuration** button.

Wait until the process finishes. To apply the new configuration, the unit has to be rebooted: the **Reboot selected** button can be used to perform the required system restarts.



**Note:** The configuration export and upload doesn't preserve the settings related to the applied transforms and to the analogue sensor type.

## 2.15 Scripting

The Minimus is capable of running a script file that contains commands to execute at specific dates and time. This can be used for operations such as scheduled instrument calibrations.

The script file is written on a computer as a .txt file. It is then sent to the digitiser as a file transfer from Discovery.

---

### 2.15.1 Enabling Scripting Capability

This capability needs to be enabled (once) on the digitiser. In order to do this, type the command below in the instrument's console:

```
resource add futrcmds 1
```

The console can be accessed from Discovery by right-clicking on the instrument's entry and selecting **Console**

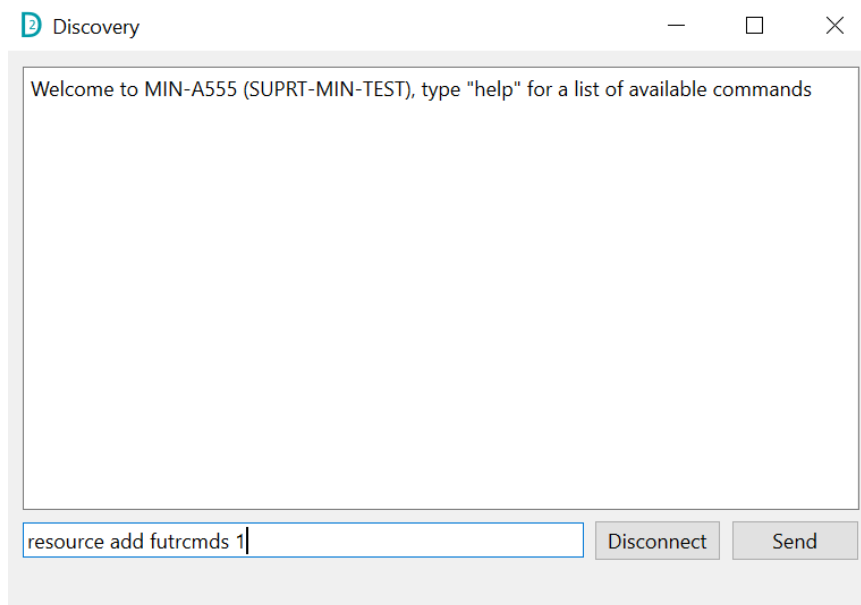

### 2.15.2 Preparing the Script File

Typing "help" in the console shows all the possible commands along with a brief explanation. Any commands available on the digitiser console can be used. The list of commands to be executed on specific dates and time has to be written to a text file with the following format:

```
2024-06-17T18:30:33Z      example command 1
2024-06-17T18:30:50Z    example command 2
```

 **Note:** The circled space is the TAB character. Using spaces instead will not work.

Time has to be specified in UTC. Please refer to the “System time” that appears on the Minimus webpage.

To edit the parameters present in the webpage, use the command “var set”. For example,

```
var set DHCP 1
```

enables DHCP. The number ‘1’ represents the enumeration of the pulldown list. Therefore,

```
var set DHCP 0
```

would disable DHCP.

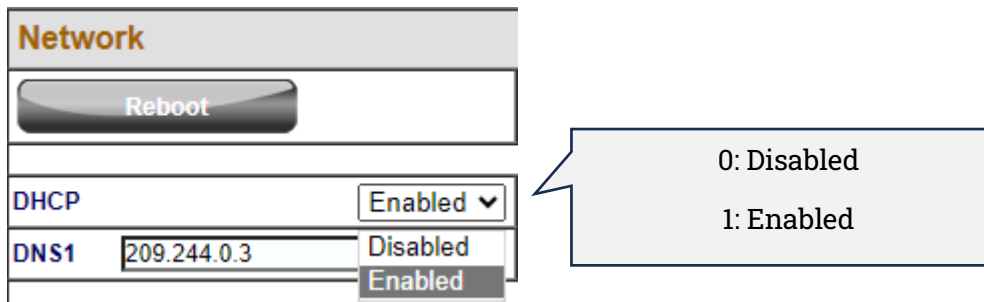

For Minimus+, where more than one sensors are available, specify on which sensor the command has to be executed by adding “n.” in front of the variable to change. For example, to enable white noise calibration signal generator on Sensor0 the command would be:

```
var set "0:Calibration" 2
```

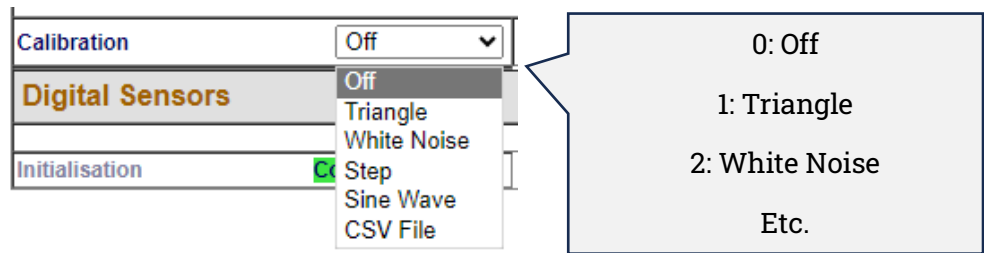

As an example, the following text will create a single step calibration (positive, then negative step 11 minutes apart) on 2023-04-17 at 03:30 UTC.

## Minimus, Minimus+, Fortimus, Certimus

```
2023-04-17T03:28:00Z    var set "0:Calibration" 4
2023-04-17T03:28:20Z    var set "0:Lookup generator gain" 0
2023-04-17T03:28:40Z    var set "0:Channel" 5
2023-04-17T03:30:00Z    var set "0:Lookup generator gain"
1106247680
2023-04-17T03:41:00Z    var set "0:Lookup generator gain" 0
2023-04-17T03:47:00Z    var set "0:Channel" 0
2023-04-17T03:47:20Z    var set "0:Calibration" 0
```

### Explanation:

```
"0:Calibration" 4
```

This command will set the signal type, in this example 4 will create a step on sensor 0. Other options include, sinewave, triangle wave and random noise. Note the script waits for 10 seconds before sending the next command.

```
"0:Lookup generator gain" 0
```

This will set the gain of the step to 0 volts, note the script waits for 10 seconds before the next command.

```
"0:Channel" 5
```

This switches the logic lines for the 'calibration enable' on all three components. Please note the script then waits 2 minutes before the next command to avoid any disruption to the analogue signals during the calibration cycle.

```
"0:Lookup generator gain" 1106247680
```

This will set the gain to 30% of maximum. The percentage on the webpage (e.g. 10) is a float. In the script though it has to be expressed in hexadecimal notation (preceded by the character \$), or decimal. Some examples:

10% = \$41200000 or 1092616192

20% = \$41A00000 or 1101004800

30% = \$41F00000 or 1106247680

```
"0:Lookup generator gain" 0
```

This will return the input signal to 0 volts. On a velocity sensor this is the equivalent of a negative step.

```
"0:Channel" 0
```

This switches off the logic lines of the 'calibration enable'.

```
"0:Calibration" 0
```

This command will switch off the DAC creating the calibration signal and stop the recording of the special calibration channel.

### 2.15.3 Sending a Script File

Once the text file with the list of commands is ready, it has to be uploaded in Discovery as a file transfer. To do this, right-click on the Minimus entry and select “File Exchange”.

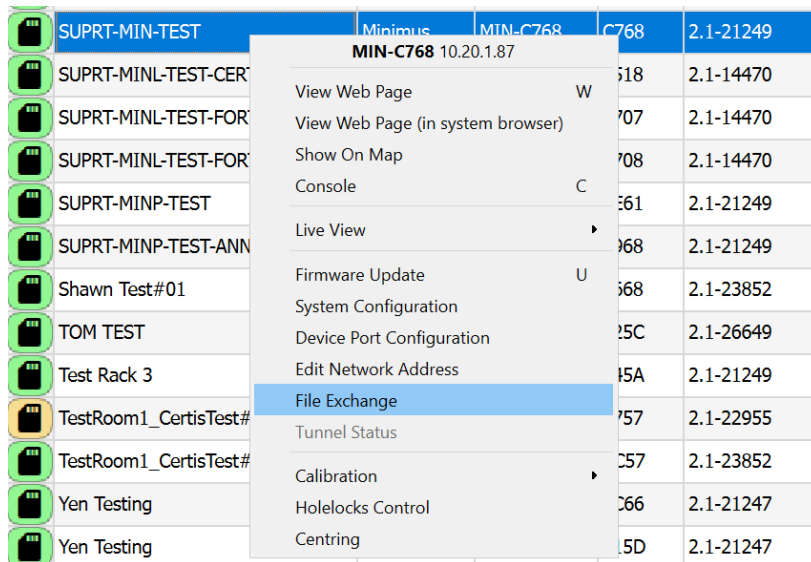

From the “File Upload” box, browse for the text file previously prepared and in the field “Upload as” type exactly `/ram/futrcmds.txt`. Click on Upload.

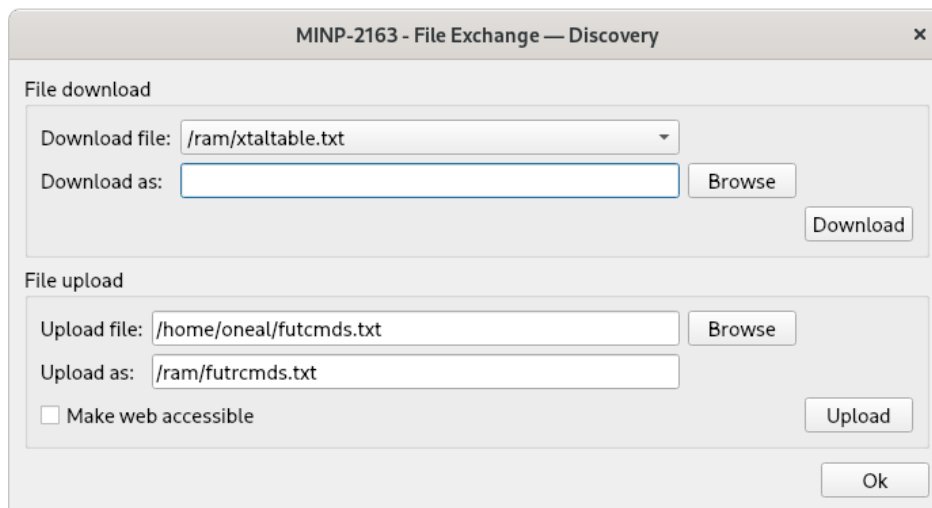

If the file has been uploaded successfully, the next command due to be executed is displayed in the Network tab as shown below. If this does not show, reboot the instrument.





Status **Network** Setup Trigger Data Stream Data Record Storage Logout Help

System type: Minimus | Host label: SUPRT-MIN-TEST | Host name: MIN-A555 (10.20.1.82) | Serial number: 0A555

Network			
<input type="button" value="Reboot"/>	Next console command	2024-06-10T14:15:00Z var set "0:Channel" 5	
Network Configuration			
DHCP	<input type="button" value="Enabled"/>	Static IP addr	169.254.149.165
		Net Mask	255.255.0.0
		Gateway	169.254.0.1
DNS1	<input type="text" value="209.244.0.3"/>	DNS2	<input type="text" value="84.200.69.80"/>

### 2.15.4 Status of the Script Running Process

To see the status of the process, type in the console:  
**futrcmds show**

Keeping in mind that the date and time refer to the system time. To visualise the system time, type in the console:  
**system time**

To remove the script and cancel queued up commands, type in the console:  
**futrcmds clear**

 **Note:** Sending a new script file replaces the existing queued up commands. The clear command removes the entire script.

## 2.16 LCD Display Menu



**Note:** This section is applicable to instruments with a LCD display. Both Certimus and Fortimus are available with or without LCD display. The LCD display is never present in Minimus and Minimus+ digitisers. In this section, both Certimus and Fortimus will be referred to as *Certimus*, for the sake of brevity.

The full colour LCD display shows the Certimus state of health, inclination and real-time output waveforms. It also allows configuration of the instrument as well as some control operations.

While the Minimus is booting up, it displays a white screen with the Güralp logo in the middle and a progress-bar at the bottom.



Once the Minimus has booted up completely, the LCD automatically displays the “status” page.

To move back to the main menu, touch anywhere in the screen and the main menu will be displayed.



**Note:** When using the touch screen, keep your finger in place on each button for approximately half a second to ensure that your touch is registered. This delay helps prevent accidental triggering of menu functions.

The LCD's touch features can be disabled completely if desired: see Section 2.16.5.3 for details. The LCD behaviour can be configured in the Minimus web interface, see Section 2.16.6 for more details.

The complete LCD menu map is illustrated in Appendix 4 on page **Error! Bookmark not defined.**

The main menu offers the following options:

- status
- settings
- alignment
- waveform

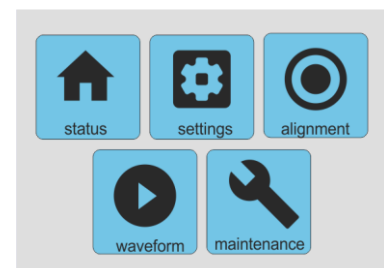

- maintenance

These are discussed in the following sections.



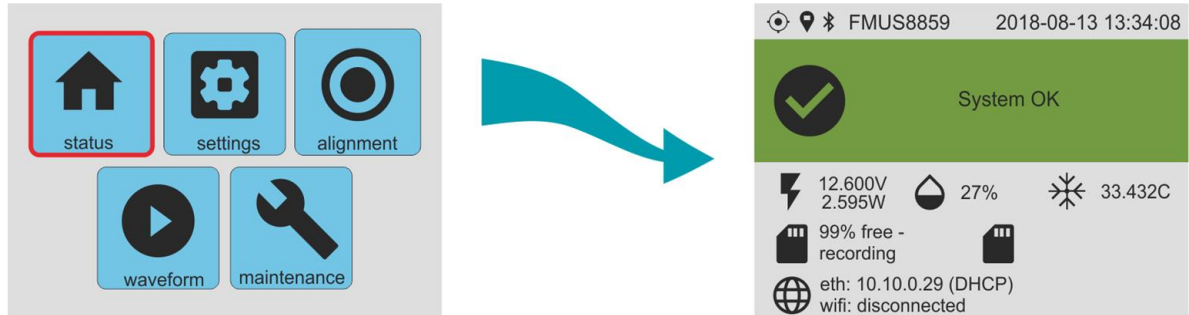

### 2.16.1 Status





The “status” page shows information about serial number, Bluetooth status, time and date, GNSS/PTP status, input voltage and power, humidity, temperature, microSD cards recording status, I.P. address.

The top of the status display shows a series of icons:



These, from left to right, correspond to synchronisation , GNSS location , WiFi reception  and Bluetooth status . The icon does not appear if the relevant service is disabled. If the service is enabled but in a fault condition (i.e. not connected or no GPS fix found), the icon is shown with a line through it.

Warning and errors are shown here when necessary. Warnings are shown with an amber triangle on a grey background , as shown on the left below. Errors are shown with a red circle on an amber background , as shown on the right.

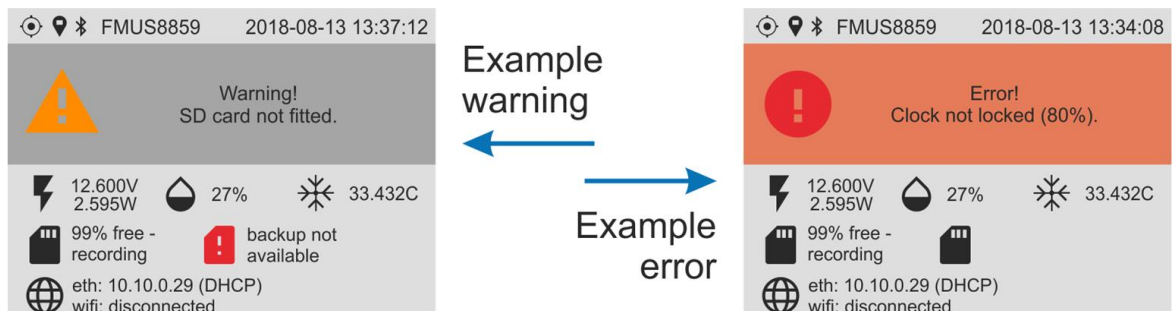

The messages that can be displayed are:

- Normal operation:

- **System OK** : GNSS or PTP are locked, microSD cards are recording.
- Warnings:
  - **Warning! SD card not fitted** : At least one of the microSD cards is not recording.
  - **Warning! Waiting for PPS lock** : PPS signal is unstable.
- Errors:
  - **Error! Clock not locked (0%)** : GNSS quality is less than 95% and PTP is not available.
  - **Error! Clock not locked (PTP 0%)** : PTP quality is less than 80% and GNSS is not available.
  - **Error! Clock not locked (NTP only)** : GNSS quality is less than 95% and PTP quality is less than 80%.

## 2.16.2 Settings



The "settings" menu offers the following options:

- display; and
- network.

These are discussed in the following sections.

### 2.16.2.1 Settings → Display

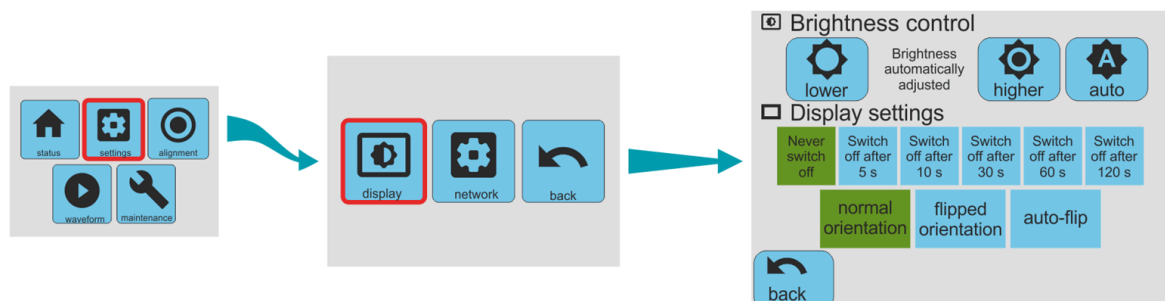

The "display" page allow control of brightness, the inactivity time-out and the orientation of the display.

## Minimus, Minimus+, Fortimus, Certimus

The brightness can be set to be adjusted automatically, based on the ambient light level, or manually adjusted with the "lower" and "higher" buttons.

The display can be set to stay on permanently (with a consequent increase in power consumption) or to automatically switch off after 5 s, 10 s, 30 s, 60 s or 120 s of inactivity. The currently-selected mode is indicated by the green background.

When the display has been switched off, it can be switched on again by touching and holding for a second.

The orientation can be set to be normal or flipped. Selecting "auto-flip" will instruct the instrument to flip the display automatically based on attitude as determined by the internal MEMS accelerometer. The currently-selected mode is indicated by the green background.

### 2.16.2.2 Settings → Network

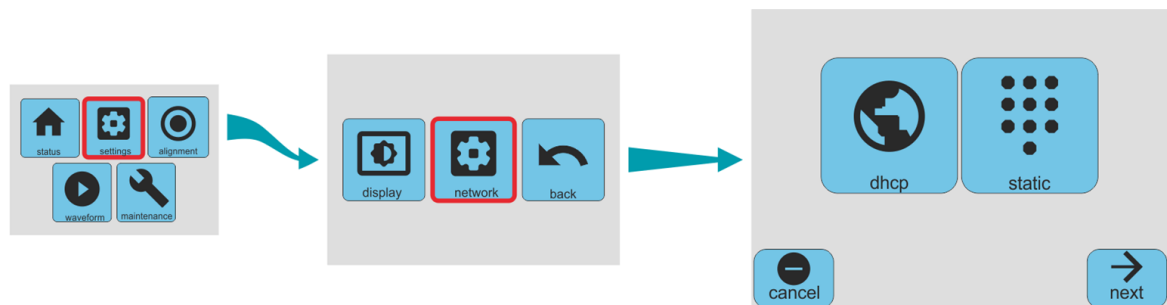

The network page allows you to choose between DHCP mode, where the networking parameters are set by an external DHCP server, or static mode, where the network parameters must be typed in manually.

The current network mode is shown on the main status display:

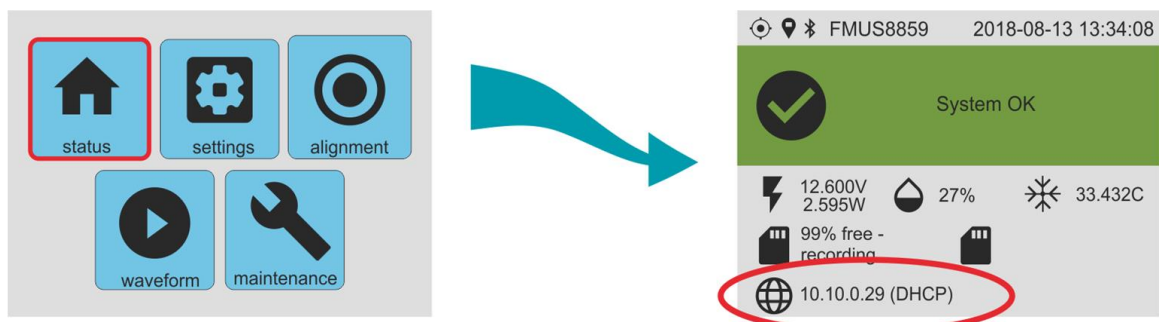

If you select DHCP mode from the network page, you are asked for confirmation but no other configuration is required:

## Minimus, Minimus+, Fortimus, Certimus

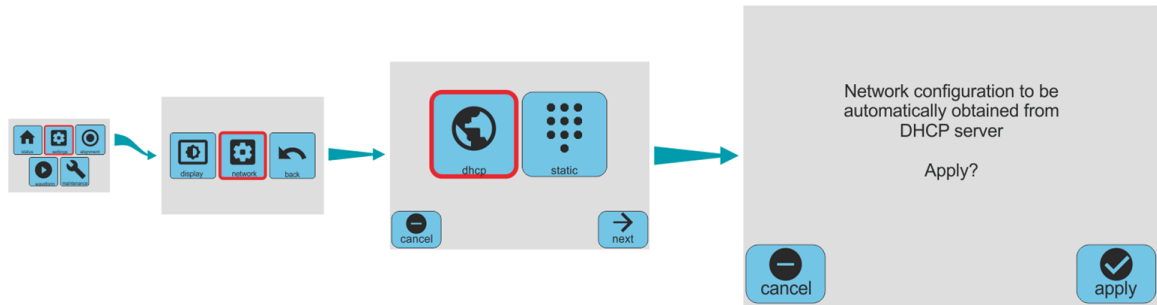

If you select static mode from the network page, you are prompted first for the IP address:

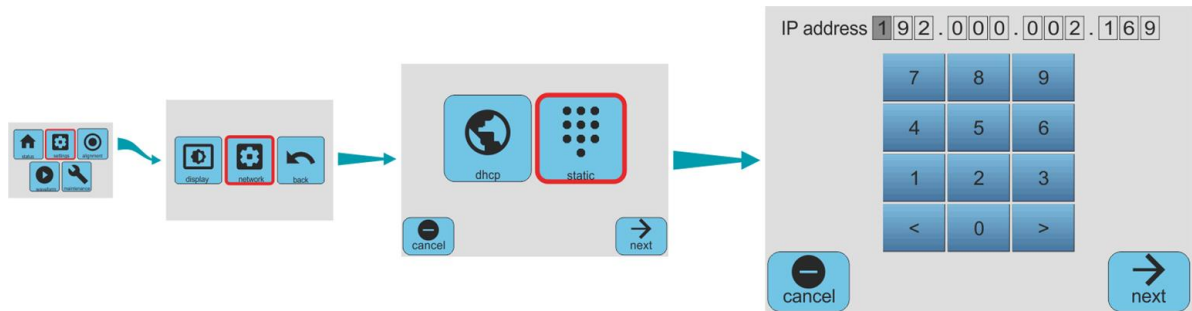

Enter the desired IP address using the on-screen virtual numeric keypad and then press "next", which takes you to the netmask screen.

Enter the desired netmask in the same way. Pressing "next" again takes you to the "Gateway IP" screen:

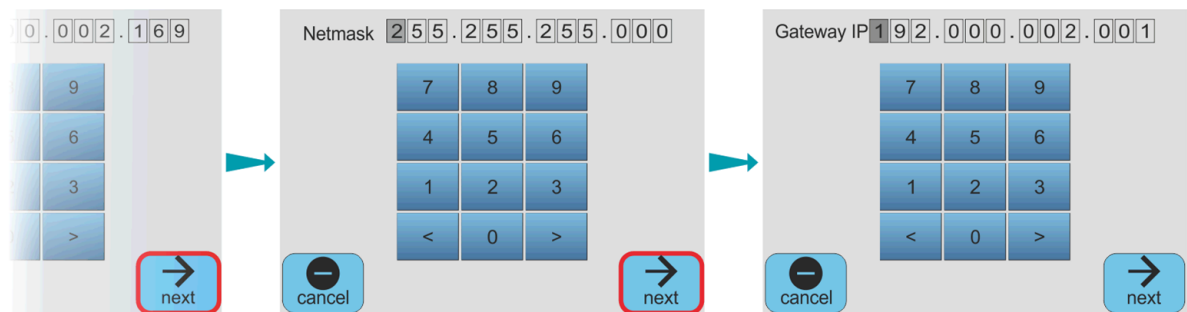

After entering the IP address of your gateway (default router), press "next" again to reach the confirmation screen:

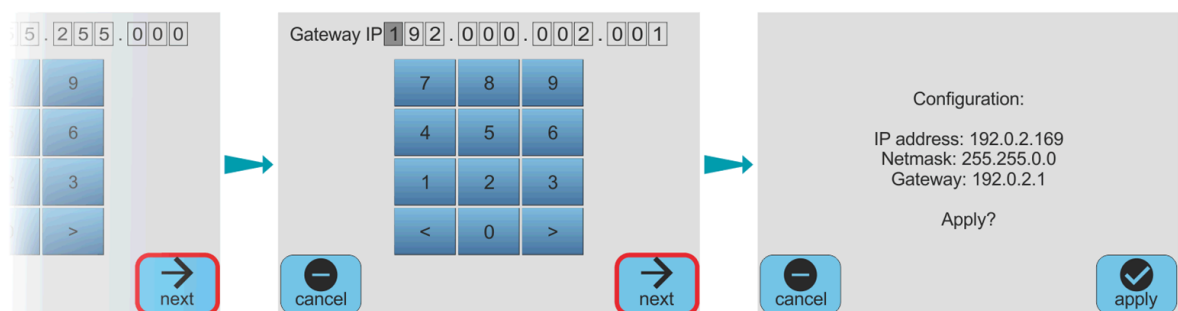

Pressing "apply" here configures the Certimus with the parameters that you have just entered. Pressing "cancel" discards all of the changes and the Certimus' networking configuration is not affected.

### 2.16.3 Alignment





The "alignment" page shows a virtual bubble level based on the output of the MEMS accelerometer built-in the Certimus. The red circle moves around the screen as the position of the Certimus is altered, mimicking the bubble in a real bubble level; i.e. the red circle moves towards the highest part of the top of the instrument.

**Note:** The virtual bubble level works if and only if the MEMS accelerometer channels are enabled for streaming and/or recording.

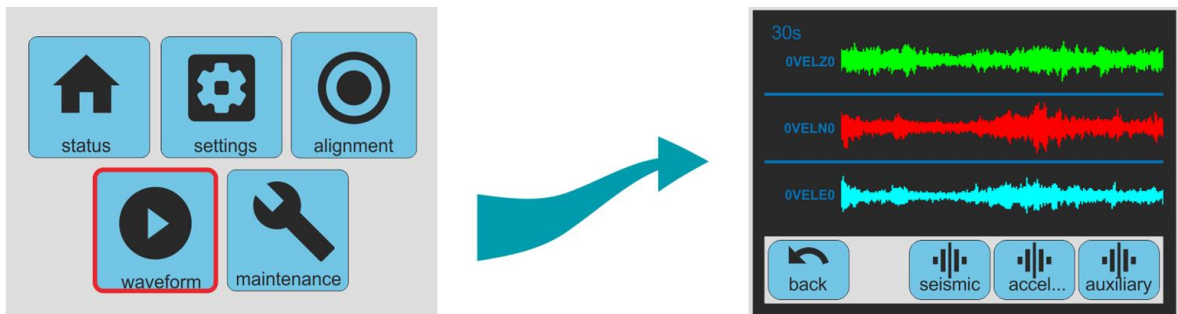
### 2.16.4 Waveform



The "waveform" page shows real-time data in graphical format. The horizontal axis represents time and the display constantly scrolls to the left as the latest data are plotted on the right-hand side of the graph. Three modes are available:

-  In "seismic" mode, the signals from the main acceleration outputs of the Certimus are displayed.
-  In "accel..." mode, the outputs from the internal MEMS accelerometer are displayed.
-  In "auxiliary" mode, the display graphs the output from the internal temperature sensor, the internal supply voltage and the power consumption.

## 2.16.5 Maintenance



The “maintenance” page allows the user to:

- reboot the system;
- reset the configuration to factory values; and
- lock the “settings” and “maintenance” pages to prevent undesired alteration.

These are discussed in the following sections.

### 2.16.5.1 Maintenance → Reboot

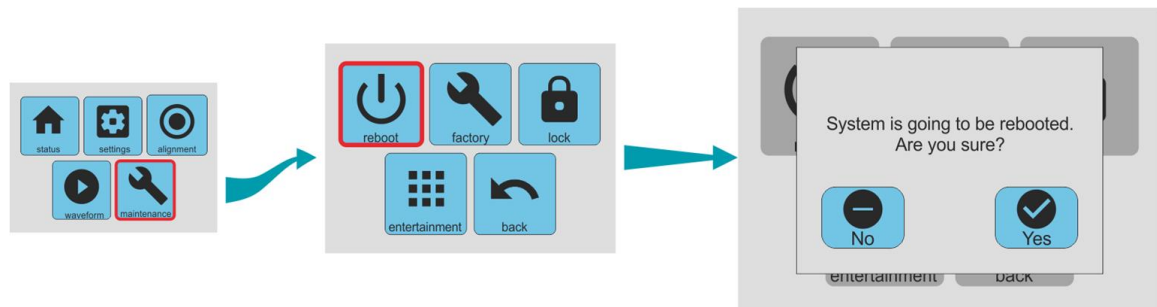

This option reboots the processor in the Minimus digitiser without interrupting power. Because this will interrupt digitisation and potentially affect the configuration (some changes only take effect after a reboot), it is protected by a confirmation screen.



Click  if you wish to continue and  if you have arrived at this screen unintentionally and wish to return to the main menu.

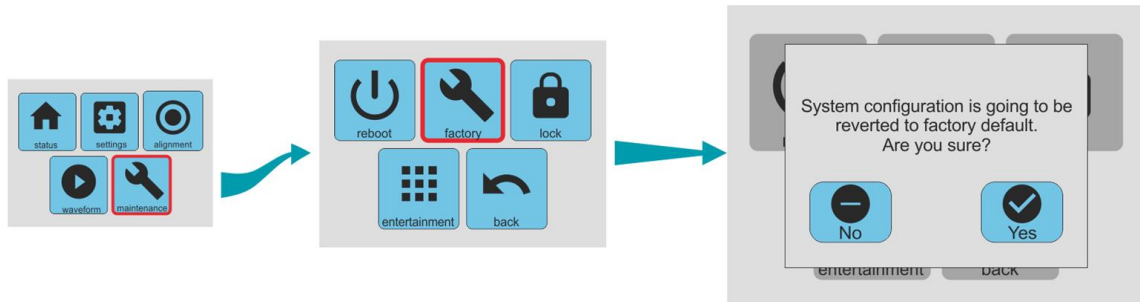

### 2.16.5.2 Maintenance → Restore Factory Settings





This option restores the configuration to the state in which the instrument was delivered. Because this will interrupt digitisation and affect the configuration, it is protected by a confirmation screen.

Click  if you wish to continue and  if you have arrived at this screen unintentionally and wish to return to the main menu.

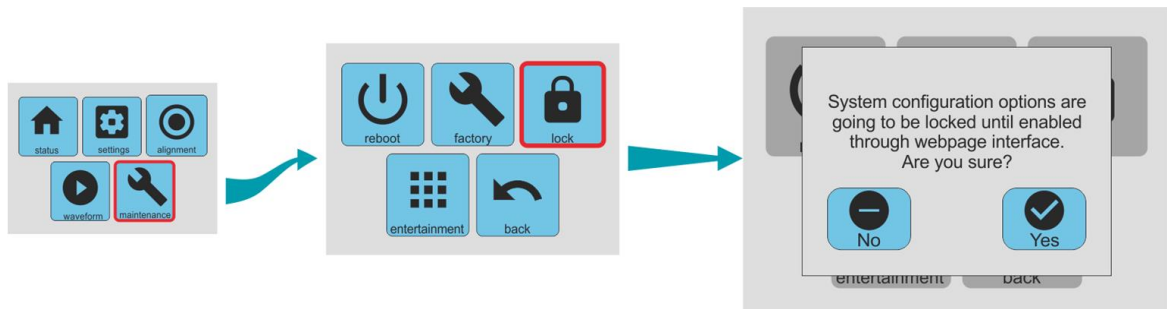
### 2.16.5.3 Maintenance → Lock the Configuration



This option locks the LCD interface so that the instrument can only be reconfigured via its web interface. This can be useful when physical access to the instrument cannot be fully controlled. Because this can be disruptive, this option is protected by a confirmation screen.

Click  if you wish to continue and  if you have arrived at this screen unintentionally and wish to return to the main menu.

 **Note:** Once “settings” and “maintenance” are locked, they can only be re-enabled from the Minimus web page. See Section 2.16.6 for more details.

## 2.16.6 Controlling the LCD from the Web Interface

In the “Setup” tab of the Certimus web page, the user can remotely control the LCD display settings.

Locking and unlocking of the “settings” and “maintenance” features can be selected using the drop-down menu named “Display settings”:

## Minimus, Minimus+, Fortimus, Certimus

Display			
Display settings	Unlocked	Display brightness	Auto
Touch sense	Unlocked	Display switch-off	Never
	Locked	Display flip	Auto

Guralp Systems Limited

The display brightness is adjustable using the drop-down menu named "Display brightness":

Display			
Display settings	Unlocked	Display brightness	Auto
Touch sense	Enable	Display switch-off	Never
		Display flip	Auto

Guralp Systems Limited

The display can be set to switch off after a selectable period of time while it is untouched. When the display is off, it can be switched back on by touching it for a couple of seconds.

Display			
Display settings	Unlocked	Display brightness	Auto
Touch sense	Enable	Display switch-off	Never
		Display flip	Auto

Guralp Systems Limited

The LCD is, by default, oriented with the top of the screen pointing North (relative to the instrument). The orientation can be flipped by 180 degrees if required or it can be set to "automatic". When the auto-flip is enabled the orientation changes according to the MEMS output.

Display			
Display settings	Unlocked	Display brightness	Auto
Touch sense	Enable	Display switch-off	Never
		Display flip	Auto
			Normal
			Auto
			Flip

Guralp Systems Limited  
Midas House, Calleva Park, Aldermaston, Reading, RG7 8EA, UK  
Tel: +44 118 981 9056, Fax: +44 118 981 9943

For security reasons, the LCD's touch sensor can be disabled using the option "Touch sense". Once disabled, touching the screen has no effect and no commands can be issued via the LCD.

To restore normal operation, set "Touch sense" to "Enable" from the Certimus web page.

## Minimus, Minimus+, Fortimus, Certimus

Display							
Display settings	Unlocked ▾	Display brightness	Auto ▾	Display switch-off	Never ▾	Display flip	Auto ▾
Touch sense	Enable ▾						
	Enable						
	Disable						

Guraip Systems Limited  
Midas House, Calleva Park, Aldermaston, Reading, RG7 8EA, UK  
Tel: +44 118 981 9056, Fax: +44 118 981 9943

 **Note:** "Touch sense" can be re-enabled only from the web interface. It is not possible to re-enable it using the LCD screen.

## 2.16.7 LCD Menu Map

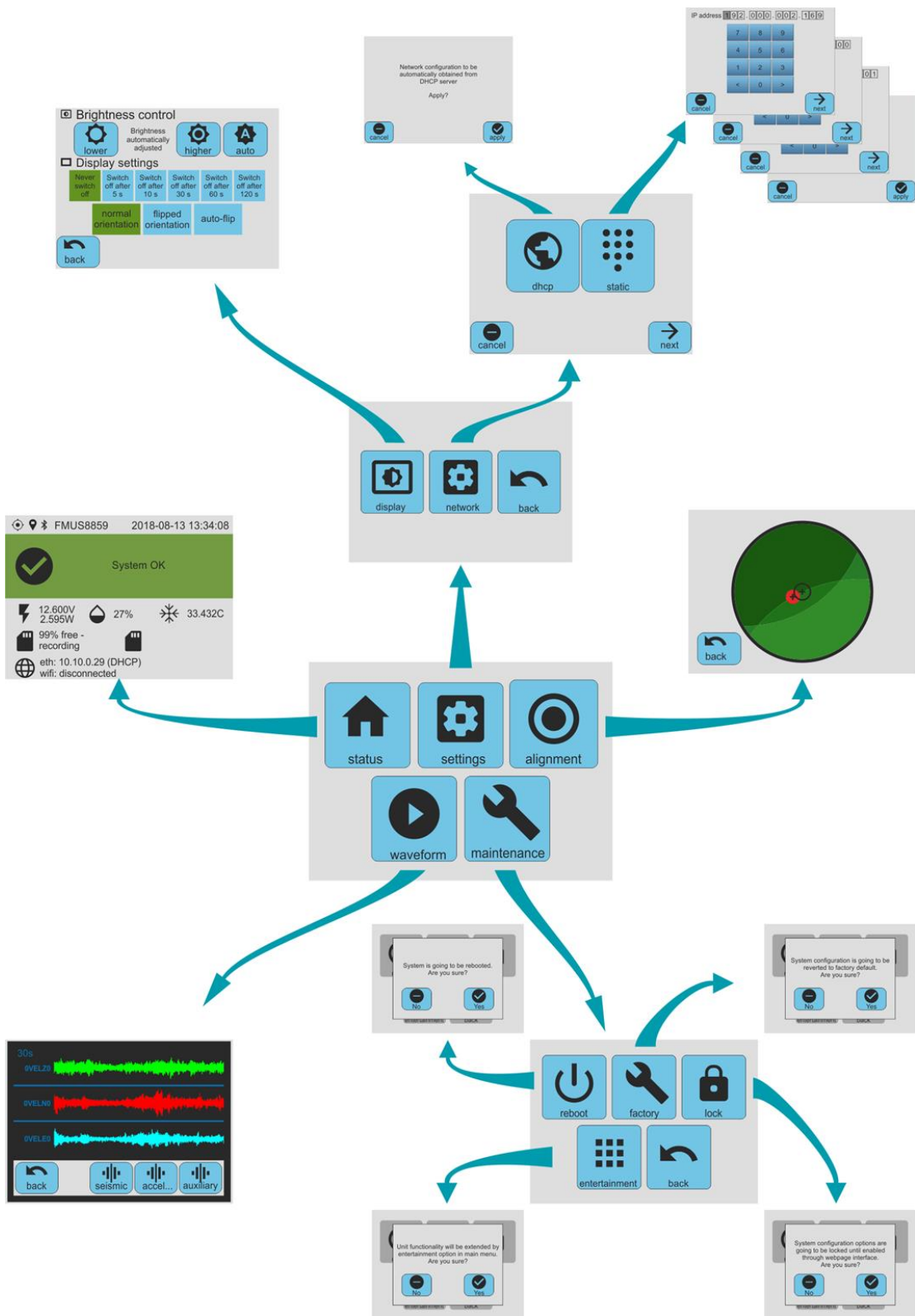

## 2.17 Bluetooth Connectivity: the GüVü App

The GüVü app provides monitoring and control of nearby Minimus units using the Bluetooth protocol. It is available for Android devices.

GüVü can be downloaded from the Google Play store at:

<https://play.google.com/store/apps/details?id=com.guralp.whisper>

### 2.17.1 Getting Started

To launch GüVü, follow the steps shown in the figure below:



Steps for launching the GüVü App:

1. Launch by clicking on the GüVü icon from either the Apps Menu or from the Home Screen.
2. Wait a few seconds for the app splash screen.
3. Press the Bluetooth icon  to enable Bluetooth connectivity (if not already enabled) and to search for available devices to with which to pair.
4. Select the appropriate device from the list to pair. Wait a few seconds for the main viewer screen to show.

The instrument connection screen can also be accessed by pressing the menu icon  on the main instrument status window, and selecting the “Connect” option.

If you experience problems connecting, try forcing GüVü to quit and then re-launching the app.

## Minimus, Minimus+, Fortimus, Certimus

Once the device is connected, the main view of the app will be displayed. This screen displays a number of status indicators associated with both the Minimus and connected sensors. These features are summarised in the figure below:

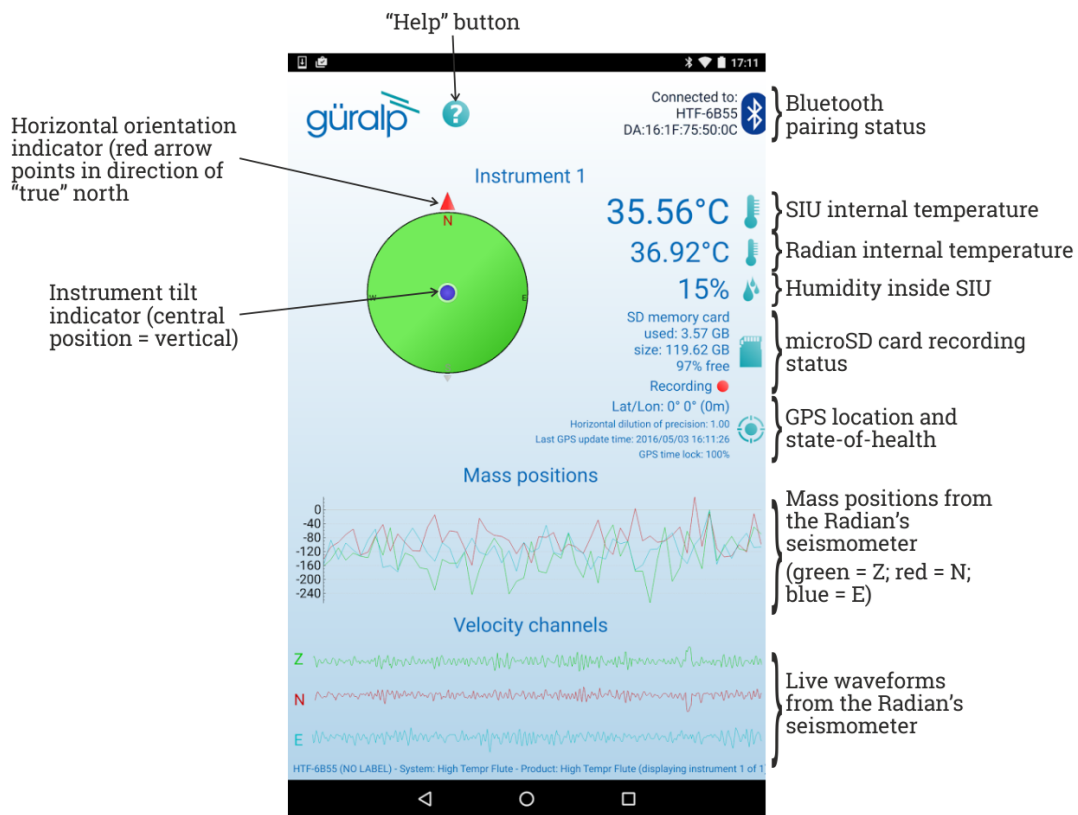

Access the menu by pressing the menu icon  on the main instrument status window:

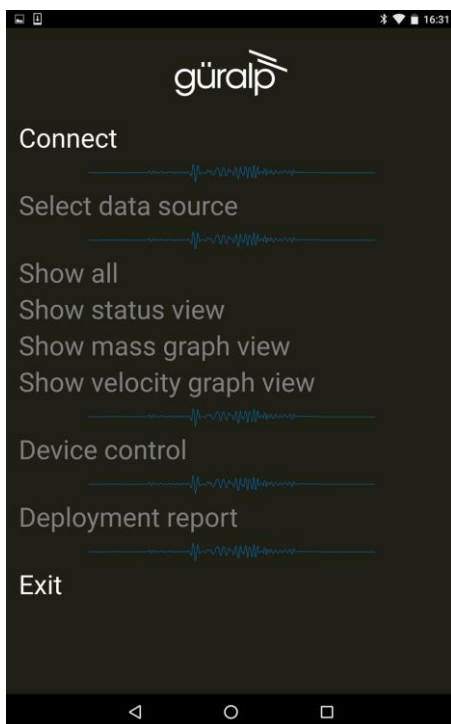

## 2.17.2 Selecting Data Sources

Güralp view can provide status information about all connected sensors, including digital instruments (*e.g.* Güralp Radian) and analogue instruments.

To select the instrument source that provides information to the main status screen of GüVü, tap the menu icon  on the main instrument status window, and then tap the "Select data source" option.

The data source selection screen shows a list of connected instruments. Select an instrument name: this is now the instrument that will be displayed on the main instrument status window.



---

## 2.17.3 View Settings

The user can customise the view of the main instrument status window. Four different view options can be cycled through by tapping the menu icon  on the main instrument status window:

- **Show all** – the default view setting; show state-of-health status, mass positions, and sensor traces on a single screen;
- **Show status view** – show state-of-health on the main screen only;
- **Show mass graph view** – show mass position traces on the main screen only; and
- **Show velocity graph view** - show sensor traces on the main screen only.

## 2.17.4 Instrument Control



Several features of the Minimus and connected instruments can be controlled and configured remotely over Bluetooth using GüVü:

- Analogue instrument centring
- Clearing and un-mounting SD card
- Rebooting the Minimus
- Enable/disable power-saving mode
- Lock/unlock sensor masses
- Station metadata (User Label, Station Name, Network Code, Site Name)
- Network setting (I.P., Netmask, Gateway)
- Changing channels' sampling rates

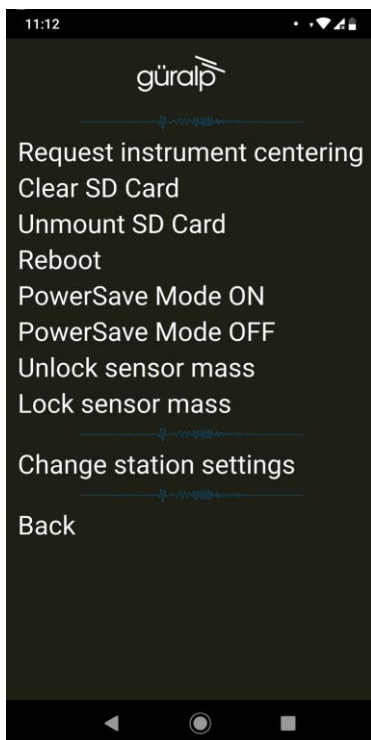
In each case, GüVü will report whether the selected command has been successfully sent to the device.



**Note:** After any modification to channels' sampling rates, the Minimus must be rebooted before the changes will take effect.

These options can be accessed by tapping the menu icon  and choosing the "Device control" option. To access the instrument control and configuration sub-menu, a PIN code has to be entered by selecting the text entry box and tapping .



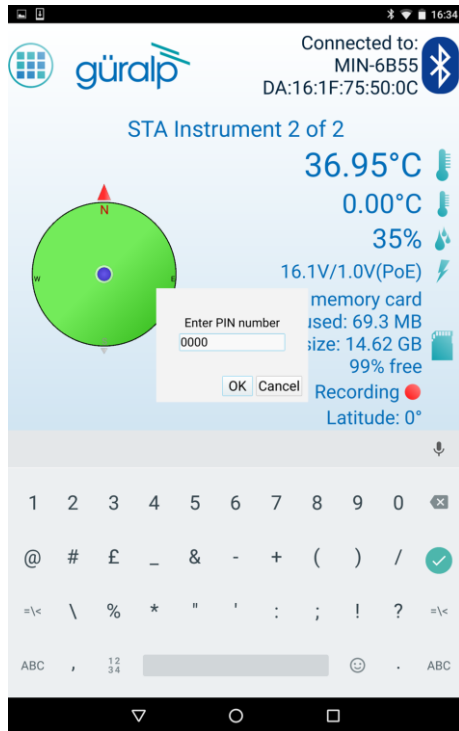

The default PIN code used to access the Instrument Control menu is "0000".



**Caution:** Güralp recommends changing the PIN code from the default, as described in the following section, in order to maintain station security.

### 2.17.4.1 Setting the PIN Code

The PIN code for accessing the instrument control menu of GüVü can be changed from the "Setup" tab of the web page. The new four-digit PIN code should be entered into the "Bluetooth PIN" field. The new value is applied by keying ; or clicking the left mouse button in any other setting box.

Digitizer Config					
Auto Refresh	<input type="text" value="1"/>	Auto Reboot	<input type="text" value="On Error"/>	Low Latency Mode	<input type="text" value="Balanced"/>
Host Label	<input type="text" value="SPRT-MIN"/>	Station Code	<input type="text" value="TEST"/>	Network Code	<input type="text" value="DG"/>
Bluetooth PIN	<input type="text" value="0000"/>	Bluetooth	<input type="text" value="Enabled"/>	Filter quality	<input type="text" value="High"/>
Deploy Mode	<input type="text" value="Normal"/>	<input type="text" value="Deploy"/>			

### 2.17.5 Emailing a Deployment Report

The GüVü app has a feature that allows the user to generate an automatic deployment report that can then be filed via email.

The deployment report includes the following details:

- System name;
- Station name;

## Minimus, Minimus+, Fortimus, Certimus

- Network code;
- Instrument user label;
- Memory card storage size and recording status;
- Location of site (GNSS latitude, longitude, elevation);
- Time of deployment;
- GNSS lock quality;
- Power supply status;
- Instrument temperature and humidity recordings.

To send a deployment report, tap the menu icon  and choose the "Deployment report" option. GüVü will then open the default email application on the device, showing a draft email which will include the parameters described above.

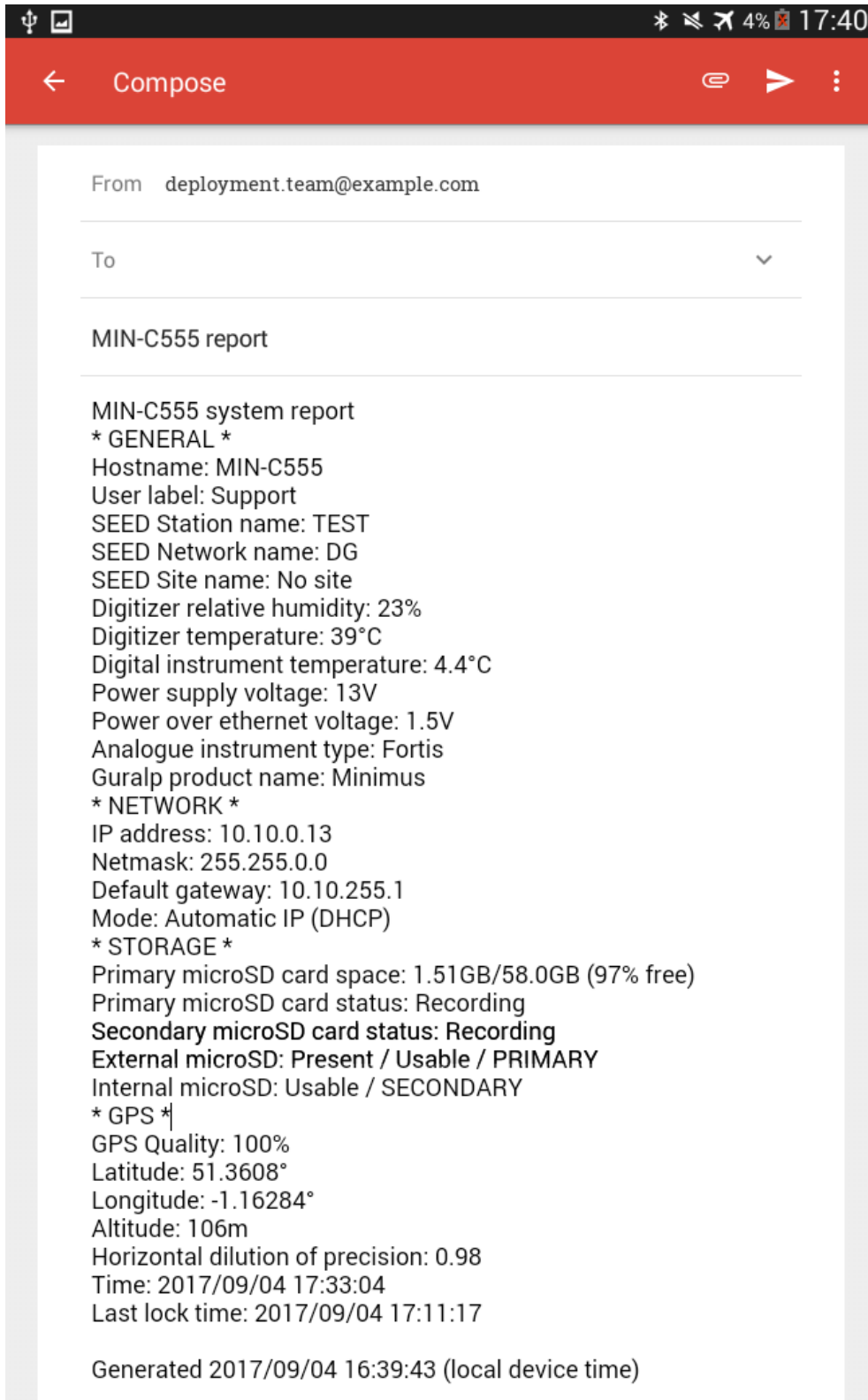

## 2.18 Advanced Troubleshooting

In the unlikely event of the user experiencing problems with the operation of the Minimus, a diagnostics tool is available via the GNSS connector. This connector provides a serial console which can be accessed using a terminal emulator.

The user should first plug in the serial adapter to the GNSS connector, which is then attached to a 9-pin COM port on your PC/laptop (if a 9-pin COM port is not available, a serial-to-USB converter should be used instead and connected to an available USB port. Güralp recommend converters based on the FTDI chip-set.)

A connection is then made using a terminal emulator, such as minicom under Linux or PuTTY under Windows. The appropriate COM port should be entered as the "Serial line", and the "Speed" should be set to 115200.

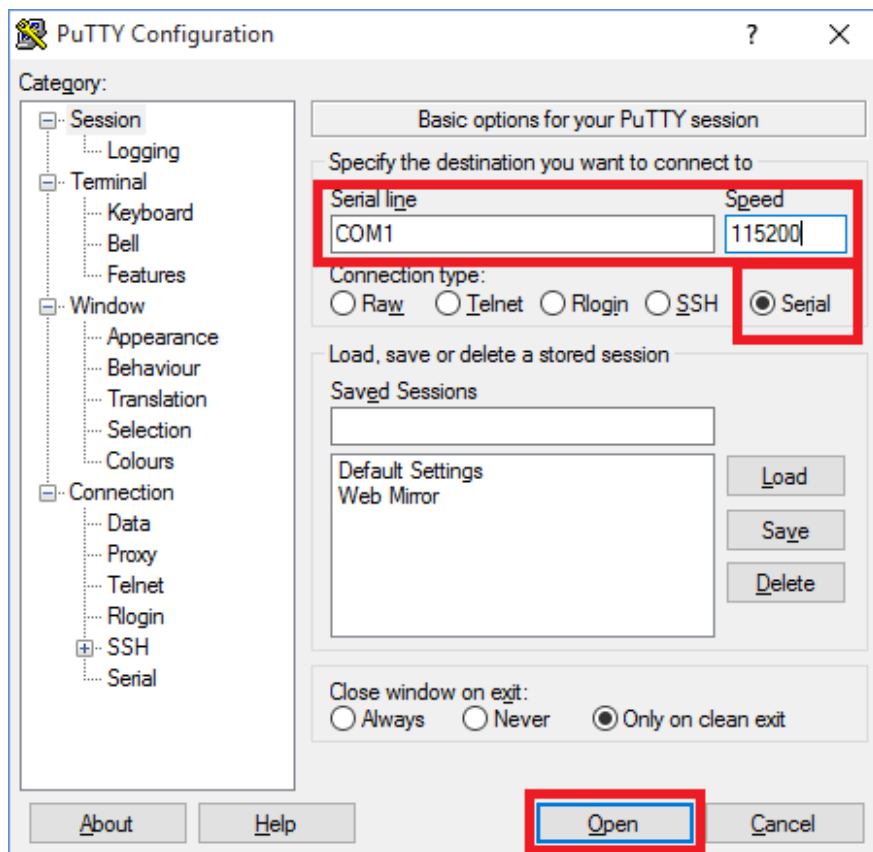

Note that the COM port can be different that COM1, especially when a USB to serial adapter is used. To find out the appropriate port, open the Device Manager of your machine.

## Minimus, Minimus+, Fortimus, Certimus

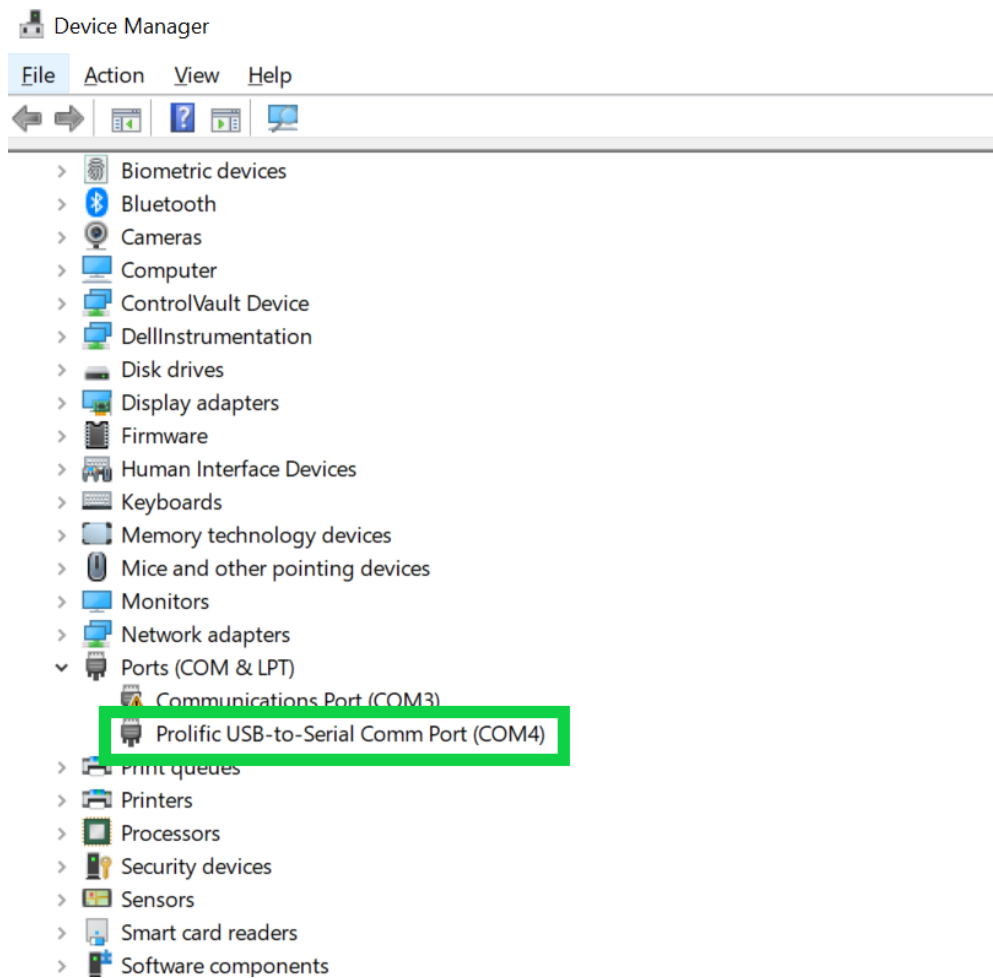

Next, select "Serial" from the bottom of the Category menu in the left-hand pane and check that the settings match those shown in the screenshot below.

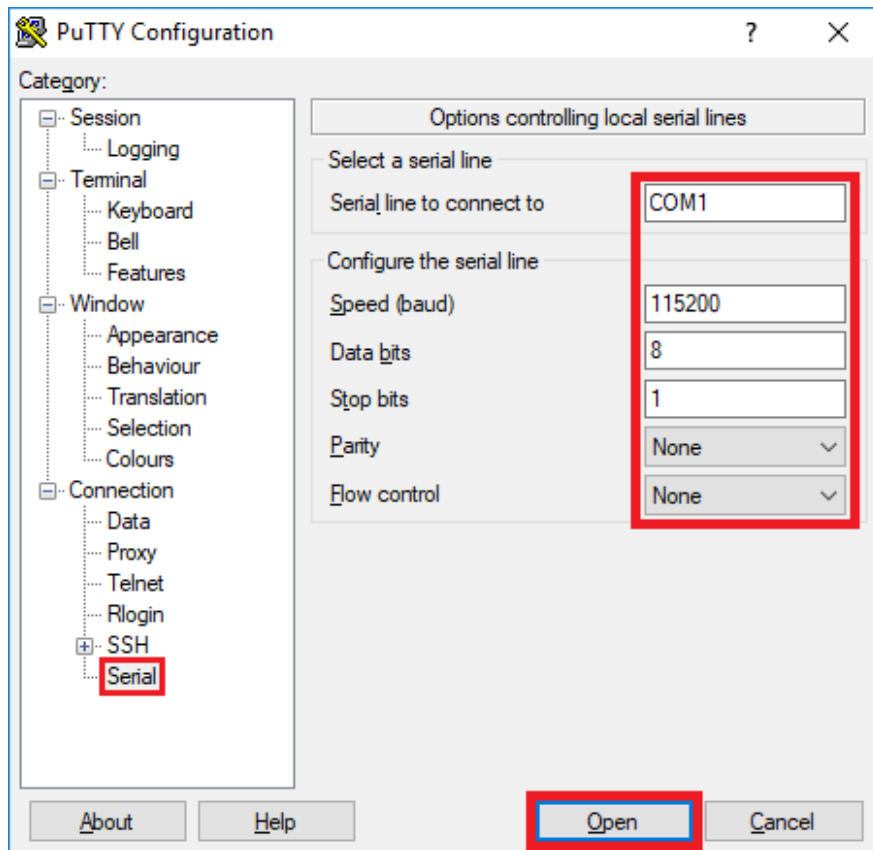

Finally click the **Open** button and a terminal window will open, connected to the console of the Minimus.

In the event of any operational issues, the Gralp Support Team may request you to interact with the console in order to diagnose and fix problems.

### 2.18.1 Reset All Settings During Boot Phase

The Minimus can be reset to its factory settings during its boot-up stage. This is useful in cases where the user is not able to communicate with the Minimus via a network connection, where the unit is not responsive, or where it does not appear in the Discovery software's scan results.

To carry out a full system reset, connect to the terminal port via a serial connection (as described in Section 2.18 ). During the middle part of the boot phase, when the text

@GURALP SYSTEMS and the firmware version number is displayed, key **Ctrl** + **R**. This causes all settings (except Username, Password and Bluetooth PIN) to revert to their factory default values, and the Minimus will re-boot. It may be necessary to enter this key combination several times.

A typical boot log is shown below, identifying the stages where **Ctrl** + **R** will cause the Minimus to reset and reboot.

## Minimus, Minimus+, Fortimus, Certimus

**Do not press any buttons during the first phase of boot-up:**

Rebooting system, please wait...

00000101

0000c1c1 RomBOOT

SCKC\_CR = 0xA, CKGR\_MOR = 0x100FF0A, CKGR\_PLLAR = 0x20FDD101, PMC\_MCKR = 0x1122, PIO\_PDSR = 0xF13F7C65

SCKC\_CR = 0xA, CKGR\_MOR = 0x100FF0A, CKGR\_PLLAR = 0x21403F01, PMC\_MCKR = 0x1302, PIO\_PDSR = 0xF13F7C65

AT91Bootstrap v3.8.10-1.guralp

NAND: ONFI flash detected

NAND: Manufacturer ID: 0x2C Chip ID: 0xDA

NAND: Page Bytes: 2048, Spare Bytes: 64

NAND: ECC Correctability Bits: 4, ECC Sector Bytes: 512

NAND: Disable On-Die ECC

NAND: Initialize PMECC params, cap: 4, sector: 512

NAND: Image: Copy 0x92000 bytes from 0xE000 to 0x2FA0E000

NAND: Done to load image

SCKC\_CR = 0xA, CKGR\_MOR = 0x100FF02, CKGR\_PLLAR = 0x21403F01, PMC\_MCKR = 0x1302, PIO\_PDSR = 0xF23F7C65

U-Boot v2019.10-1.guralp

CPU: SAMA5D36

External clock: 12.288 MHz

CPU clock: 497.664 MHz

Master clock: 165.888 MHz

DRAM: 256 MiB

NAND: 256 MiB

MMC: Atmel mci: 0, Atmel mci: 1

Loading Environment from NAND... OK

In: serial

Out: serial

Err: serial



## Minimus, Minimus+, Fortimus, Certimus

```
Net: eth0: ethernet@f0028000
word at 0xfffffea20 (0x06) != word at 0x23000008 (0x07)
Total of 0 word(s) were the same
PHY 0x07: OUI = 0x0885, Model = 0x22, Rev = 0x02, 10baseT, HDX
Hit any key to stop autoboot: 0

NAND read: device 0 offset 0x5C0000, size 0x360000
 3538944 bytes read: OK
Uncompressed size: 5008508 = 0x4C6C7C
crc32 for 21000000 ... 214c6c7b ==> 6f7d4b5e
Total of 2 word(s) were the same
word at 0xfffffea20 (0x06) != word at 0x23000008 (0x07)
Total of 0 word(s) were the same
## Starting application at 0x00300000 ...

(boot)Crash Info###
  Number of crash left=0
(boot)Last crash time:1970-01-01T00:00:00.000
Board type set to: Minimus
Recognised external clock: 12288000 Hz
SCKC_CR = 0xA, CKGR_MOR = 0x100FF02, CKGR_PLLAR = 0x21403F01, PMC_MCKR =
0x1302, MCK = 165888000 Hz

@GURALP SYSTEMS
```

Once the “@GURALP SYSTEMS” banner has been printed, keying  +  (at least once) will cause all settings (except Username, Password and Bluetooth PIN) to revert to their default values and cause the Minimus to reboot.

```
v2.0-7548 by teamcity on 14:28:48 07-Nov-2019
Vecbase: 300000 CPUid: 410fc051 Cache: c5187d
PMT init
Unsafe to change DBGU clock while running
mux start SP 300fb4
FPU start
VFP Id=41023051
```



## Minimus, Minimus+, Fortimus, Certimus

```
0.00 | -> init_dbgprint
0.00 | -> init_cmdutils
0.00 | -> init_pmt_dlg
0.00 | -> init_memdlg
0.00 | -> malloc_debug
0.00 | -> start_timer_interrupts
0.01 | -> rtc_init
RTC Time: 2019-11-08T14:23:11 UTC
0.01 | -> uart_start_ints
0.01 | -> init_arm_parse
0.01 | -> t_init_task_utils
0.01 | -> gpio_init
##### NORMAL INITIALISATION MODE #####
0.01 | -> unit_test_init
0.01 | -> init_devio
0.01 | -> init_usart
0.01 | -> init_devio_cmds
0.01 | -> rpc_init
0.01 | -> ram_init
0.01 | -> ram_exchange_init
0.01 | -> system_update_init
```

If your key-strokes have been recognised, **Ctrl+R** will be printed in the boot log, as shown below – once for each time your keystrokes were logged:

```
C0.01 | -> i2c_init
i2c_configure( 0, 100000Hz )
Using pclk 41472000, cdiv 203, shift 0 => 100173
i2c_configure( 1, 100000Hz )
Using pclk 41472000, cdiv 203, shift 0 => 100173
i2c_configure( 2, 100000Hz )
Using pclk 41472000, cdiv 203, shift 0 => 100173
0.01 | -> i2c_dac_init
```

**Ctrl+R**

**Ctrl+R**

## Minimus, Minimus+, Fortimus, Certimus

Ctrl+R

Ctrl+R

Ctrl+R

Ctrl+R

Ctrl+R

```
0.01 | -> i2c_dac_init
0.01 | -> i2c_humid_init
Humidity sensor test SUCCESS
0.01 | -> fram_init
Installing NVR device. size 12640
0.04 | -> net_sockets_init
0.06 | -> newtask_init
USE ADC MINIMUS
0.07 | -> init_whalesong
0.07 | -> analog232_init
0.07 | -> start_timers
Warning non-integer microsecond divisor from 82944000
0.08 | -> spi_datalink_init_semaphores
0.09 | -> chain_init
Using 251 coefficients.
0.15 | -> var_user_init

[SD log not available!] User variable "last_loc_lat" modified (called from
load_from_fram)

[SD log not available!] User variable "last_loc_lon" modified (called from
load_from_fram)

[SD log not available!] User variable "station_start_t" modified (called
from load_from_fram)

[SD log not available!] User variable "DHCP" modified (called from
load_from_fram)

[SD log not available!] User variable "Static IP addr" modified (called
from load_from_fram)

[SD log not available!] User variable "Net Mask" modified (called from
load_from_fram)

[SD log not available!] User variable "Gateway" modified (called from
load_from_fram)

[SD log not available!] User variable "DNS1" modified (called from
load_from_fram)
```

## Minimus, Minimus+, Fortimus, Certimus

```
[SD log not available!] User variable "DNS2" modified (called from
load_from_fram)

[SD log not available!] User variable "Username" modified (called from
load_from_fram)

[SD log not available!] User variable "Password" modified (called from
load_from_fram)

[SD log not available!] User variable "tunnel_password" modified (called
from load_from_fram)

[SD log not available!] User variable "tunnel_username" modified (called
from load_from_fram)

[SD log not available!] User variable "tunnel_connection" modified (called
from load_from_fram)

[SD log not available!] User variable "Host Label" modified (called from
load_from_fram)

[SD log not available!] User variable "Station Code" modified (called from
load_from_fram)

[SD log not available!] User variable "Network Code" modified (called from
load_from_fram)

[SD log not available!] User variable "Site Name" modified (called from
load_from_fram)

[SD log not available!] User variable "Bluetooth PIN" modified (called
from load_from_fram)

[SD log not available!] User variable "Filter quality" modified (called
from load_from_fram)

[SD log not available!] User variable "CAP Msg HMAC Key" modified (called
from load_from_fram)

[SD log not available!] User variable "Registry Address" modified (called
from load_from_fram)

[SD log not available!] User variable "tunnel_url" modified (called from
load_from_fram)

[SD log not available!] User variable "Password (Normal)" modified (called
from load_from_fram)

[SD log not available!] User variable "Username (Admin)" modified (called
from load_from_fram)

[SD log not available!] User variable "Password (Admin)" modified (called
from load_from_fram)

[SD log not available!] User variable "Username (Normal)" modified (called
from load_from_fram)

[SD log not available!] User variable "Group ID" modified (called from
load_from_fram)

0.45 | -> calibration_init

1.91 | -> gcftx_init
```

## Minimus, Minimus+, Fortimus, Certimus



```
1.92 | -> spi_datalink_chains_init
Sensor0 is velocimeter
Sensor1 is accelerometer
Sensor2 is velocimeter
Sensor3 is velocimeter
Sensor4 is velocimeter
Sensor5 is velocimeter
Sensor6 is velocimeter
Sensor7 is velocimeter
Sensor8 is velocimeter
3.33 | -> init_nand
4.17 | -> adc12_init
4.18 | -> init_random
4.18 | -> ltc4151_vc_monitor_init
Voltage/Current readings are not provided by LTC4151 chip.
4.19 | -> voltage_sniffer_init
4.20 | -> init_lut
4.28 | -> i2c_humid_init_ui
4.30 | -> sd_init
4.31 | -> sd_file_init
4.31 | -> sd_log_init
4.31 | -> streaming_client_init
2019-11-08T14:23:15.000Z Retime Request Waiting (35s/3600s/Boot delay)
4.33 | -> xtaltable_init
No XTAL table found.
4.40 | -> gps_pps_init
Chain 54 already set.
Chain 54 already set.
Chain 54 already set.
Chain 54 already set.
Chain 54 already set.
Chain 54 already set.
Chain 54 already set.
Chain 54 already set.
Chain 54 already set.
```



## Minimus, Minimus+, Fortimus, Certimus

```
MIN-C555-> 4.44 | -> init_var_debug
4.44 | -> tcpdump_init
4.45 | -> var_html_init
4.45 | -> init_http_server
4.46 | -> sd_init_var
4.46 | -> gps_pps_ui_init
4.46 | -> xtaltable_ui_init
checking for xtaltable.txt
4.47 | -> init_fpga_datalink
4.47 | -> init_auto_center
4.48 | -> init_embedded_fs
4.48 | -> status_txt_init
4.49 | -> lan_init_web

####tx_lock:
majic:f710f7f7
Call_lock value:-1 4.50 | -> init_responder_ui
4.51 | -> init_tunnel_ui
4.52 | -> quasar_init
Quasar Serial Isolated Input/Output Module support is disabled.
4.53 | -> quasar_init_ui
4.53 | -> applied_rot_init_web
4.54 | -> installation_parameters_init_web
4.55 | -> init_fpga_web
4.62 | -> analog232_init_web
4.73 | -> init_transforms
4.74 | -> triggers_init_ui
5.02 | -> chain_init_web
10.52 | -> transform_init_web
13.14 | -> storage_init_web
13.19 | -> spi_datalink_ui_init
13.32 | -> gps_init_ui
13.33 | -> gps_init
```

## Minimus, Minimus+, Fortimus, Certimus

Once the boot-up reaches this stage, pressing  +  will have no effect.

If  +  was recognised during the second stage of boot-up, then the Minimus will reset and reboot:

**Ctrl+R NVR load, resetting all vars to their default values and then rebooting**

Forcing all vars to default values (including non-default-able)

PPS clock sources ACTIVE: 0x00000001 [GPS:0 PTP:0 RTC:0 TABLE:1]

PPS clock sources ACTIVE: 0x01000001 [GPS:1 PTP:0 RTC:0 TABLE:1]

PPS clock sources ACTIVE: 0x01010001 [GPS:1 PTP:1 RTC:0 TABLE:1]

PPS clock sources ACTIVE: 0x01010101 [GPS:1 PTP:1 RTC:1 TABLE:1]

Ctrl+R

Ctrl+R

Ctrl+R

sd\_manager: probed both microSD card slots

11.58 {calibration.c;1142} calibration\_write\_to\_fram: successfully wrote calib to FRAM

11.60 {var\_nvr.c;773} 'sd\_format\_time' \$20301021 --> \$00000000

11.61 {var\_nvr.c;773} 'sd\_unmount\_time' \$22647008 --> \$00000000

11.62 {var\_nvr.c;773} 'pps\_src\_table' 168 --> 1

11.63 {var\_nvr.c;773} 'pps\_src\_gps' 0 --> 1

11.63 {var\_nvr.c;773} 'pps\_src\_ptp' 69 --> 1

11.64 {var\_nvr.c;773} 'pps\_src\_rtc' 132 --> 1

11.64 {var\_nvr.c;773} 'rtcSavedOffsetSecs\_nv' -1737983855 --> 0

11.65 {var\_nvr.c;773} 'rtcSavedOffsetNano\_nv' 402788896 --> 0

11.66 {var\_nvr.c;773} 'rtcSavedFreqErrorPPB\_nv' -2129883872 --> 1000000

11.67 {var\_nvr.c;773} 'rtcSavedOffsetTime\_nv' \$52080158 --> \$00000000

11.68 {var\_nvr.c;773} 'xtaltable\_offset' 610275339 --> 0

# Revision History

A	2024-05-31	Initial release.
---	------------	------------------