

# Aquarius

## Free fall OBS with acoustic telemetry

### Technical Manual

Document Number: MAN-AQU-0002

Issue C – August **Error! Reference source not found.**

---

|       |  |    |
|-------|--|----|
| 1     | Preliminary Notes .....                | 5  |
| 1.1   | Proprietary Notice .....               | 6  |
| 1.2   | Warnings, Cautions and Notes .....     | 6  |
| 1.3   | Manuals and Software .....             | 6  |
| 1.4   | Conventions .....                      | 6  |
| 2     | Introduction .....                     | 7  |
| 2.1   | Description .....                      | 7  |
| 2.2   | Applications .....                     | 7  |
| 2.3   | Summary of key features .....          | 8  |
| 3     | Getting started .....                  | 9  |
| 3.1   | Unpacking and packing .....            | 9  |
| 3.2   | System overview .....                  | 9  |
| 3.2.1 | The Aquarius .....                     | 10 |
| 4     | The Aquarius in detail .....           | 12 |
| 4.1   | Seismic sensor .....                   | 12 |
| 4.2   | Ultra Low Power Digitiser (ULPD) ..... | 12 |
| 4.3   | Low Power Computer (LPC) .....         | 13 |
| 4.4   | Acoustic modem .....                   | 14 |
| 4.5   | The battery system .....               | 15 |
| 4.6   | Accessory Devices .....                | 15 |
| 4.6.1 | APG .....                              | 15 |
| 4.6.2 | Hydrophone .....                       | 16 |
| 4.7   | Keller pressure sensor .....           | 16 |

## Aquarius Ocean Bottom System

|       |   |    |
|-------|---|----|
| 4.8   | Buoyancy .....  | 16 |
| 4.9   | Recovery aids .....                                   | 16 |
| 4.9.1 | Satellite Tracker .....                               | 16 |
| 4.9.2 | LED strobe .....                                      | 17 |
| 4.10  | Ballast and release system .....                      | 17 |
| 4.11  | The Underwater Cable Loom .....                       | 18 |
| 4.12  | Connectors on the Aquarius canister .....             | 19 |
| 4.13  | Lifting frame .....                                   | 20 |
| 5     | Battery changing .....                                | 21 |
| 5.1   | Charger box .....                                     | 21 |
| 5.2   | Batteries charging specifications .....               | 22 |
| 5.3   | Charging cable .....                                  | 23 |
| 5.4   | Charging the batteries .....                          | 23 |
| 5.4.1 | Connecting the charger .....                          | 23 |
| 5.4.2 | Operating the charger unit .....                      | 24 |
| 6     | Deck unit and surface dunker .....                    | 25 |
| 6.1   | Deck unit block diagram .....                         | 25 |
| 6.2   | Side connectors panel .....                           | 25 |
| 6.3   | Connect to the ULPD and to the LPC consoles .....     | 26 |
| 7     | Configuration and Control .....                       | 27 |
| 7.1   | Configuration and Control through Discovery .....     | 27 |
| 7.1.1 | How to connect to Aquarius .....                      | 27 |
| 7.1.2 | Live view .....                                       | 30 |
| 7.1.3 | OBS Command & Control .....                           | 33 |
| 7.2   | Configuration and Control through Web Interface ..... | 47 |
| 7.2.1 | Network configuration .....                           | 47 |
| 7.2.2 | PTP .....   | 48 |
| 7.2.3 | Setting up streamed data .....                        | 50 |
| 7.2.4 | Setting up recorded channels .....                    | 52 |
| 7.2.5 | Download recorded data .....                          | 55 |
| 7.2.6 | Acoustic modem set-up .....                           | 60 |
| 7.2.7 | Deploying the Aquarius .....                          | 61 |
| 7.2.8 | Calibration data .....                                | 62 |
| 8     | Pre-deployment procedures .....                       | 65 |
| 8.1   | Charging batteries .....                              | 65 |
| 8.2   | Attach Ballast and Burn-Wire System .....             | 65 |

## Aquarius Ocean Bottom System

|        |  |     |
|--------|--|-----|
| 8.2.1  | Locate System on Ballast.....                      | 65  |
| 8.2.2  | Tension Burn-Wire.....                             | 68  |
| 8.3    | Time synchronization and configuration.....        | 74  |
| 8.4    | Acoustic communication check.....                  | 74  |
| 8.5    | Final assembling.....                              | 75  |
| 9      | Post Deployment procedure.....                     | 76  |
| 9.1    | Checking seismometer's data.....                   | 76  |
| 9.2    | OBS Locator.....                                   | 76  |
| 9.2.1  | Overview.....                                      | 77  |
| 9.2.2  | Locating Aquarius.....                             | 77  |
| 9.2.3  | Data processing.....                               | 82  |
| 9.2.4  | Log Files.....                                     | 88  |
| 10     | Recovery procedure.....                            | 91  |
| 10.1   | Releasing the ballast.....                         | 91  |
| 10.2   | Locating the Aquarius on the sea surface.....      | 91  |
| 10.3   | Recover the Aquarius and check the time drift..... | 91  |
| 10.4   | Download the data.....                             | 92  |
| 11     | Appendix A – Channel names.....                    | 93  |
| 11.1   | Data streaming.....                                | 93  |
| 11.2   | Data recording.....                                | 94  |
| 12     | Appendix B – Connector pin-outs.....               | 96  |
| 12.1   | OBS – APG/Hydrophone and Burn-Wire.....            | 96  |
| 12.2   | OBS – Ethernet and Serial RS-232.....              | 97  |
| 12.3   | OBS – Battery charger.....                         | 98  |
| 13     | Appendix C – Deployment check-list.....            | 100 |
| 14     | Appendix D – Recovery check-list.....              | 104 |
| 15     | Appendix E – Acoustic Modem link.....              | 106 |
| 15.1   | Description of Operation.....                      | 106 |
| 15.1.1 | Modem Configuration.....                           | 107 |
| 15.2   | Sonardyne Debugger.....                            | 110 |
| 15.3   | Troubleshooting.....                               | 115 |
| 15.3.1 | Send a short Command.....                          | 116 |
| 15.3.2 | Read Modem Status.....                             | 118 |
| 15.3.3 | Get OBS System Information.....                    | 118 |
| 15.3.4 | Get Seismic Data.....                              | 120 |
| 16     | Appendix F – config.ini file.....                  | 123 |

## Aquarius Ocean Bottom System

|        |                                    |     |
|--------|------------------------------------|-----|
| 16.1   | Sections list.....                 | 123 |
| 16.1.1 | Section “Settings” .....           | 123 |
| 16.1.2 | Section “Calibration” .....        | 130 |
| 16.1.3 | Section “Instruments” .....        | 135 |
| 16.1.4 | Section “DataStream” .....         | 135 |
| 16.1.5 | Section “AnaloguePowerBoard” ..... | 137 |
| 17     | Appendix G – Glossary.....         | 146 |
| 18     | Revision history .....             | 148 |

# 1 Preliminary Notes

## 1.1 Proprietary Notice

The information in this document is proprietary to Güralp Systems Limited and may be copied or distributed for educational and academic purposes but may not be used commercially without permission.

Whilst every effort is made to ensure the accuracy, completeness and usefulness of the information in the document, neither Güralp Systems Limited nor any employee assumes responsibility or is liable for any incidental or consequential damages resulting from the use of this document.

---

## 1.2 Warnings, Cautions and Notes

Warnings, cautions and notes are displayed and defined as follows:



**Warning:** A black cross indicates a chance of injury or death if the warning is not heeded.



**Caution:** A yellow triangle indicates a chance of damage to or failure of the equipment if the caution is not heeded.



**Note:** A blue circle indicates a procedural or advisory note.

---

## 1.3 Manuals and Software

All manuals and software referred to in this document are available from the Güralp Systems website: [www.Güralp.com](http://www.Güralp.com) unless otherwise stated.

---

## 1.4 Conventions

Throughout this manual, examples are given of command-line interactions. In these examples, a fixed-width typeface will be used:

`Example of the fixed-width typeface used.`

Commands that you are required to type will be shown in bold:

**Example of the fixed-width, bold typeface.**

Where data that you type may vary depending on your individual configuration, such as parameters to commands, these data are additionally shown in italics:

*Example of the fixed-width, bold, italic typeface.*

Putting these together into a single example:

*System prompt: user input with variable parameters*

## 2 Introduction

Thank-you for purchasing a Güralp Aquarius.

This manual describes the key components of an Aquarius system.

### 2.1 Description

The Aquarius system is a state-of-the-art ocean bottom seismometer comprising:

- Aquarius

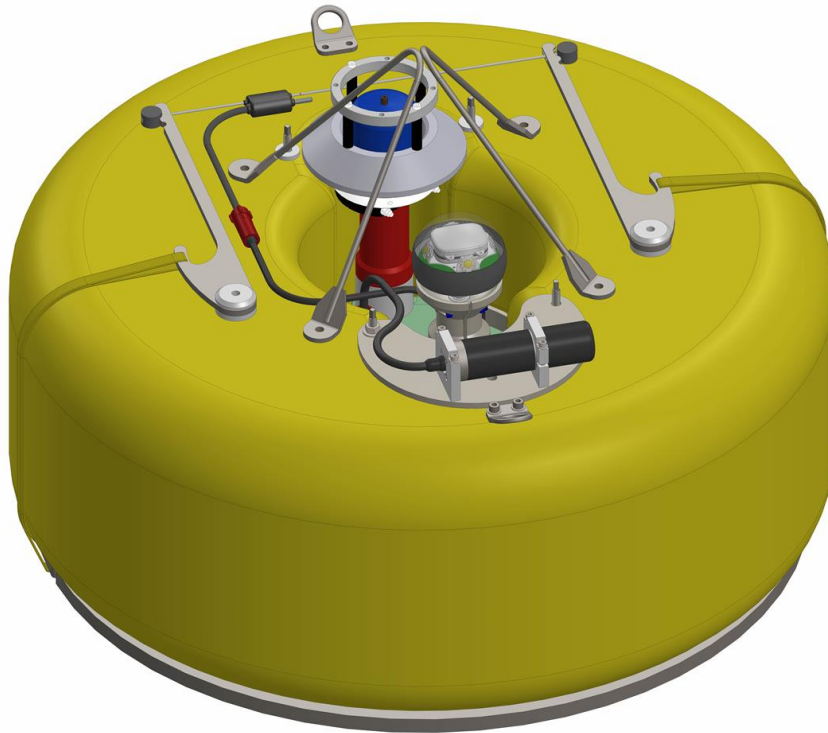

- Güralp Aquarius Deck Unit
- Mini Dunker acoustic modem
- Ethernet and serial cable
- Güralp Aquarius Charger unit with charger cable

### 2.2 Applications

- Local and regional seismic research

## 2.3 Summary of key features

- Compact OBS equipped with an acoustic modem.
- Digital feedback triaxial broadband seismometer, operational at any angle, with a flat response between 120s and 100Hz.
- A three-axis magnetometer and a MEMS accelerometer calculates the seismometer's 3D position on the seabed.
- Transmission of sensor data and State of Health parameters from the seabed following installation.
- Up to 9000bps transmission of data between seabed and surface using acoustic communication.
- Dual redundant 128GB Micro-SD card.
- Single cable connection to the Güralp deck unit for Gigabit Ethernet data download, system configuration and external power.
- Acoustic Burn-Wire release mechanism with satellite tracking system.
- LED strobe light to guide recoveries, with location alerts sent via email, SMS and/or webpage.
- Operational depth 6000 meters.



## 3 Getting started

### 3.1 Unpacking and packing

The Aquarius OBS is delivered in an environmentally-friendly, flat-packable, suspension packaging. The packaging is specifically designed for the Aquarius system and should be re-used whenever you need to transport the sensor. Please note any damage to the packaging when you receive the equipment and unpack on a clean surface.



**Caution:** The Aquarius OBS contains sensitive mechanical components which can be damaged by mishandling. If you are at all unsure about the handling or installation of the device, you should contact Güralp Systems for assistance.

- Do not bump or jolt any part of the equipment when handling or unpacking.
- Do not kink or walk on the data cable (especially on rough surfaces such as gravel), nor allow it to bear the weight of the sensor.
- Do not connect the instrument to power sources except where instructed.
- Never ground any of the output signal lines from the sensor.



**Warning:** The Aquarius OBS with ballast weighs around 350 kg in air and 26 kg in water. Improper storage or handling may cause injury, disability or death. Always follow recognised safety procedures for heavy equipment handling.

### 3.2 System overview

The heart of the system is the Aquarius Ocean Bottom Seismometer (OBS) unit, deployed on the seabed. This is a battery powered triaxial seismometer with ancillary multi-parametric sensors and data-logger. The unit may be additionally supplied with an absolute pressure gauge or a hydrophone. The Aquarius is equipped with an acoustic modem to provide data telemetry and status information to the surface and it is designed for deployments on the sea bed of the duration of over a year and with a working depth of 6000m. Also included are satellite tracker and LED strobe to aid location during recovery.

## Aquarius Ocean Bottom System

During deployment and recovery operations, it is possible to control and configure the Aquarius or offload the data using a PC or the Güralp waterproof deck unit. The Güralp deck unit can also be connected to a surface dunker acoustic modem providing data telemetry to the deck with the Aquarius in the water. Being equipped with lithium ion batteries, the Güralp deck unit can be operated on deck without the use of any mains electricity supply.

The Aquarius battery can be re-charged using the charger unit provided with the system.

### 3.2.1 The Aquarius

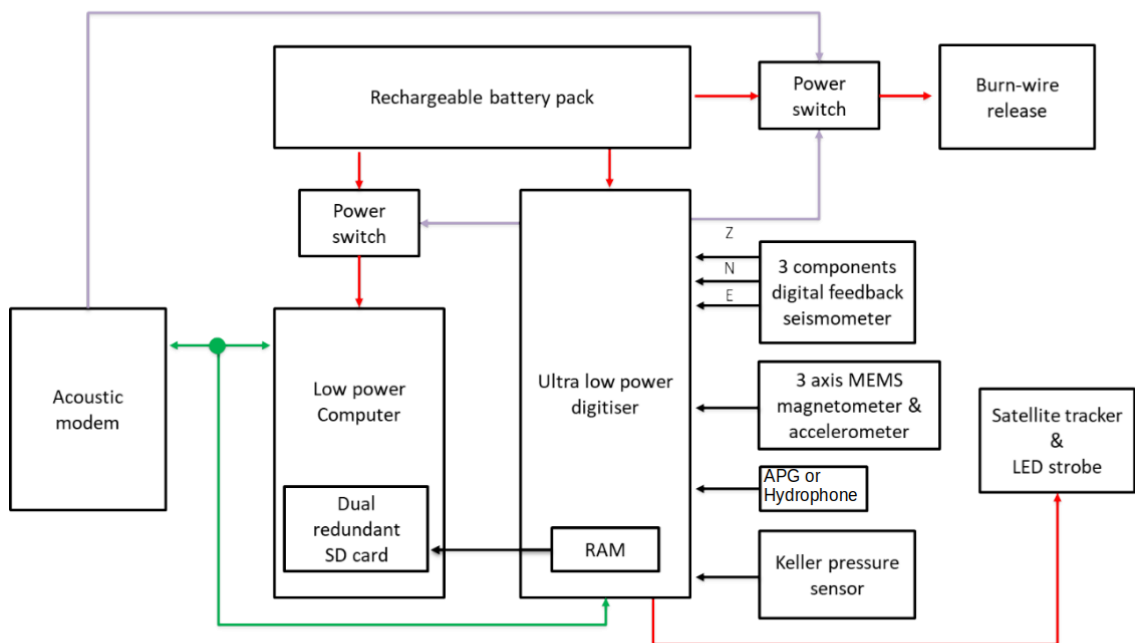

The Aquarius is the sea-floor unit of the system. It includes a weak motion triaxial digital broadband velocity seismometer, which is operational at any angle, without the need of any gimbal system. A three-axis magnetometer and a MEMS accelerometer allow calculation of the main sensor's 3D position on the seabed.

Additional sensors included are: a Keller piezoresistive pressure transducer, used to measure the depth of the OBS and to automatically turn on the recovery aids when the system is rising back to the surface. Optionally the Aquarius may also include a Paroscientific Absolute Pressure Gauge (APG) used to measure accurate water column pressure variations or an ultra-low frequency pressure compensated hydrophone.

All the sensors transmit data to an Ultra Low Power Digitiser (ULPD), which monitors and controls the system. The ULPD is always running when power is provided. Seismic and environmental data is temporally stored in the volatile memory (RAM)

## Aquarius Ocean Bottom System

of the ULPD and flushed into the dual redundant Micro SD cards of a Low-Power Computer (LPC) every 45 minutes.

The LPC is mainly powered off and it can be waken up using the power switch activated by the ULPD when a data flush is needed or in case of activity of the integrated acoustic modem, for more details see Section 4 on page **Error! Bookmark not defined..**

The acoustic modem with directional or omni-directional transducer is installed to communicate with the deck unit during deployment and recovery. Most of the time the acoustic modem is in sleep mode and it wakes up when it receives an acoustic wakeup signal or when receiving data from the LPC serial.

The OBS is powered by rechargeable Lithium-ion batteries sized to last for up to 15-months deployment.

The Burn-Wire release system can be activated either by the acoustic modem when receiving the related release command, or by a timer in the ULPD.

The ULPD also controls the satellite tracking system and the LED strobe, which are activated during the recovery procedure.

## 4 The Aquarius in detail

### 4.1 Seismic sensor

The seismometer installed in the Aquarius is a weak motion orthogonal three-axis digital feedback broadband velocity sensor, with flat response between 120s and 100Hz and sensitivity equivalent to an analogue 2000V/m/s sensor. The seismometer is operational at any angle, without the need of any gimbals, thus guaranteeing the end user the ability to record good data whichever way the OBS lands on the seabed. A three-axis magnetometer and a MEMS accelerometer are also included to allow calculation of the seismometer's 3D position on the seabed, allowing the end user to rotate the signals in post-processing. Raw data from the MEMS and from the magnetometer are sent to the surface only when a "Status" is requested from the surface via acoustic modem. These data are not stored in the SD card.

The seismometer is located at the bottom of the central part of the low-profile pressure canister for best coupling with the seabed sediments.

The components of the Aquarius seismometer do not need to be locked during transportation and deployment. The sensor will auto-centre the three components. If centring operation fails, the unit will wait and retry after a time interval. The time interval will double every time it fails to centre.

### 4.2 Ultra Low Power Digitiser (ULPD)

The core of the OBS is a 5-channel Ultra Low Power Digitiser (ULPD); with 24-bit resolution, it monitors and controls the systems including, power distribution and storage of data so it is always running when power is connected.

Three channels of the digitizer are used for the three components of the seismic sensor, a fourth for the (optional) hydrophone and the fifth channel is used for the Keller pressure sensor.

The ULPD has three main states:

- Undeployed
- Deployed and recording
- Deployed without recording.

The ULPD is in the "undeployed" state, only after a power cycle (when the off plug is removed, see Section 4.12 on page **Error! Bookmark not defined.**) or after a system reset (see Section 7.1.3.2 on page 35). In this state the system is in high power mode and is synchronising the clock with PTP.

Just before a deployment the user will have to bring the ULPD to the “Deployed and recording” state (see Section 7.2.7 on page **Error! Bookmark not defined.** and Section 7.1.3.2 on page 37). In this state the system will be in low power mode and the clock is free running.

After the recovery the ULPD can be set to the “Deployed without recording” state following the procedure described in Section 10.3 on page **Error! Bookmark not defined.**. In this state the system will be in high power mode, but clock synchronising is disabled.

In “Deployed and recording” state sensors data are stored in the volatile memory (RAM) before being offloaded to the LPC’s Micro SD cards. What is stored is configured prior to deployment. To optimize the power consumption, all the recorded channels have a fixed sample rate and are called FR (Fixed Recording), see Section 7.2.4 on page **Error! Bookmark not defined.**.

An offload of data will be triggered every 45 minutes. The ULPD will also calculate the STA, the LTA and their ratio stream. If required, a threshold trigger can be set on the ratio stream to force a data offload to the LPC when an event is detected. Whenever an offload occurs, the ULPD will boot up the LPC, enabling it to process the data and store them in the SD card after which the ULPD will power off the LPC.

The acoustic modem output is also monitored by the ULPD. This is used to turn on the LPC when data is received through the modem, allowing it to manage the acoustic communication.

A timer can be set in the ULPD for activation of the Burn-Wire release system. This is usually used as a back-up of the acoustic system: in the unlikely event that the release system cannot be activated via acoustic modem, the ULPD will release the ballast at the pre-set time.

The ULPD also monitors the PoE power supply, when this comes on, the LPC will boot up or re-boot, in full power mode with the LAN enabled.

The ULPD is equipped with a triaxial **Micro Electro-Mechanical Systems (MEMS)** accelerometer with a measurement range of  $\pm 2g$  and a Magnetometer. These are used to calculate the orientation of the Aquarius when it is on the sea bed.

The ULPD clock is a double temperature compensated VCXO and at stable temperature is expected to drift less than a millisecond per day.

There is a serial console access to the ULPD, available when the OBS is on the surface, this is available through the Seacon Hummer series connector on the top of the Aquarius canister (see Section 12.2 on page **Error! Bookmark not defined.**).

---

## 4.3 Low Power Computer (LPC)

The main computer in the unit is a Güralp Minimus, configured as an Aquarius. The operation principles of the LPC are largely identical to that of a Minimus, please refer to the Güralp Minimus manual MAN-MIN-0001 for non-OBS specific topics outside of this document.

## Aquarius Ocean Bottom System

This Low-Power Computer (LPC) has a much more powerful processor and it uses significantly more power than the Ultra Low Power Digitiser, this is why the LPC is powered off by the ULPD when not required.

When power is applied to the LPC it can boot in different modes, depending on the ULPD state. When the ULPD is “undeployed” the LPC will boot up in full power mode with the LAN enabled. If the LPC is booting up with the ULPD either in “deployed and recording” state or in “deployed without recording” state, the LPC will boot in low power mode with the LAN disabled. Turning the PoE on, whatever is the ULPD state, it will reboot the LPC with the LAN enabled. For this reason, when the ULPD is either in “deployed and recording” state or in “deployed without recording” state, the LPC web server will be accessible only by turning on the PoE.

The LPC firmware manages the acoustic communication, being able to perform operations requested via acoustic commands sent from the surface through Discovery software.

The LPC will also be turned on by the ULPD when the latter sees acoustic data transmission.

When the LPC boots in the Deployed state to offload data, it will be in low power mode so it will not only transfer the data to the SD cards.

When the OBS is first powered on, it is in a Pre-Deployment mode: LAN enabled, not recording and aiming to get a time lock from the PTP time server. When the LPC will be synchronized by PTP, the time will be passed to the ULPD.

Clicking the “Deploy” button starts data recording in the ULPD and will shut down the LPC. The “Deploy” state is also recorded in the ULPD and it is maintained until next power cycle. The ULPD clock will start free running when the “Deploy” button is pressed. When the LPC boots in “Deploy” mode it will be in low power mode and the LAN will be off.

At the recovery, the system will have to be powered by PoE to reboot the LPC in normal power mode, with the LAN on. Clicking the “Stop Recording” button will stop the recording in the ULPD, but will keep it in deployed state. The time offset between the LPC time, synchronized via PTP, and the ULPD free running clock should be noted down once PTP stability is close to 100%. Clicking the “Undeploy” button will reset to the “undeployed” state and reboot both LPC and ULPD **without saving the time offset**.

There is a serial connection to the LPC, when the Aquarius is on the surface, this is available on the Seacon Hummer connector (see Section 12.2 on page **Error! Bookmark not defined.**).

---

## 4.4 Acoustic modem

The Aquarius is equipped with a directional or omni-directional acoustic modem to communicate with the deck unit during deployment and recovery. Most of the time

the acoustic modem will be in sleep mode using very little power. The modem will change to listen mode when it receives a wakeup signal acoustically or from the OBS. The modem will go back to sleep mode after 4 minutes of inactivity.

In sleep mode the modem has a nominal power consumption of 7.4mW and it is powered by 2S batteries (see Section 4.5 on page **Error! Bookmark not defined.**). When it is awake the input voltage range is 11-16.8V and it is powered at 14V by the built-in power board installed in the Aquarius. The acoustic modem has a slant range >8,000m (typically 10,000m) and it uses a Lower Medium Frequency (LMF) rated for operations up to 6000m depth.

The acoustic modem can directly control the Burn-Wire for the ballast release and it is activated by the 14V supply.

---

## 4.5 The battery system

The unit is equipped with rechargeable Lithium-ion batteries sized for a 15-month deployment. Re-charge time is approximately 1-hour charge for 1-month deployment.

The batteries are arranged in groups of 39 cells, connected in parallel, referred to as a 1S. Each cell has a nominal capacity when fully charged of 3.5Ah. When flat the batteries will be at 2.5V, rising up to 4.25V when fully charged.

Within the OBS there are 6 compartments, each of which contains a battery pack. This battery pack is referred to as a 2S, as it is composed by 2 x 1S packs connected together in series.

The battery packs are connected back to the system as individual units to allow greater flexibility and to allow each 1S to be monitored independently, when charging. See Section 5 on page **Error! Bookmark not defined.** for details about the charging process.

The total capacity of the 6 x S2 packs (468 cells total) is 819Ah @ 7.27V nominal. The overall energy stored in the full pack of batteries is 5954.13Wh.



**Caution:** Lithium ion batteries can explode violently if incorrectly charged. Use only the supplied charging equipment and always follow the instructions when charging.



**Caution:** Air transport safety regulations limit the maximum battery wattage allowed when travelling on a passenger plane to 100Wh, making it illegal to transport these batteries on a passenger flight.

## 4.6 Accessory Devices

---

### 4.6.1 APG

The Aquarius may be fitted with an 8CB4000-I Paroscientific Absolute Pressure Gauge (APG) with 400bar full scale and 0.01% accuracy. Resolution can go up to  $10^{-8}$  (nanoresolution), but in order to reduce its power consumption, the APG has been set to work in standard mode (parts per million resolution). The APG provides the ultimate precision in water level measurements and is ideal for applications such as Tsunami detection, wave and tide gauges or as accurate depth sensor.

The APG is connected via RS-232 serial interface to the ULPD that records its data at a fixed sample rate of 5sps.

---

### 4.6.2 Hydrophone

The Aquarius may be fitted with a HTI-04-PCA / ULF hydrophone with a 0.01Hz to 8kHz frequency response and -194dB (1V/ $\mu$ Pa) sensitivity.

The hydrophone is connected to the ULPD, which digitises and records its data at a fixed sample rate of 100 sps.

---

## 4.7 Keller pressure sensor

The Aquarius is fitted with a piezoresistive pressure transducer type Keller PA-10L with full scale 400bar and has an accuracy of 0.25%. The transducer can resolve water depth to 0.1m.

This sensor is used to calculate the depth of the OBS when a "status" is requested via acoustic link and it is also used to automatically turn on the recovery aids when the instruments come back to the surface.

---

## 4.8 Buoyancy

The buoyancy of the Aquarius is provided by a syntactic foam block and allows it to come back to the surface when the ballast is released. The circular buoyancy block is placed over the Aquarius canister, with a central hole allowing access to the top of the sensor canister. The buoyancy is painted Signal Yellow to aid visibility.



## 4.9 Recovery aids

### 4.9.1 Satellite Tracker

Aquarius includes a satellite asset tracker housed in a 4.5" Vitrovex glass sphere. The system is powered by the OBS internal battery pack.

When the OBS comes toward the surface and the reading of the Keller pressure sensor indicates a suitable depth (about 15m), the recovery system is switched on.

When the recovery system is on, the satellite tracking system will get a GPS fix and transmit the position using the satellite modem embedded in the system. The position is sent every 35 minutes via email and SMS or it is retrievable using a web portal.

An example of web portal is Wireless Innovation in the image below (<https://wil.rock7.com>).



### 4.9.2 LED strobe

The recovery system also includes a set of four bright LEDs, housed in the Vitrovex glass sphere. The LED strobe is switched on together with the satellite tracker by the pressure sensor.

To minimize power consumption, the LED strobe will be switched off during day by a phototransistor. The strobe will automatically turn on during night or in poor light conditions.

## 4.10 Ballast and release system

The ballast for the Aquarius is provided by a double-layer steel ring attached to the bottom of the Aquarius. The ballast is suspended from the Aquarius by two straps,

## Aquarius Ocean Bottom System

one either side, which are held in tension by two arms on the top of the unit. These arms are held together by a single Burn-Wire.



To release the unit a current is passed between the Burn-Wire and a cathode, causing the Burn-Wire to corrode rapidly, thus breaking and releasing the unit. When the Burn-Wire has broken the unit will float to the surface thanks to the lifting force provided by the syntactic foam block.

The Burn-Wire release can be activated either by the acoustic modem or by the timer set in the ULPD. When the modem sends the command, the power to burn the wires is provided by the same switching supply used to power the acoustic modem and providing 14V. In this scenario, it takes approximately 10 minutes for the wire to break. In the other case, when the ULPD activates the sequence, only a 2S batteries voltage is sent to the Burn-Wire system and the release takes around 20 minutes. This time, being related to the voltage provided to the Burn-Wire system, will depend on the State of Charge of the batteries.

---

## 4.11 The Underwater Cable Loom



The underwater cable loom is composed by 3 cables and it is used to connected an accessory device (APG or hydrophone) to the Aquarius canister and also to activate the Burn-Wire.

A 2-way Subconn connector provides power to the burn wire.

If fitted, a Burton 8-way connector is used to connect the APG sensor and it provides power and serial communication to the digital pressure sensor.

Alternatively and if fitted, a 4-way Subconn connector provides signal and power connections to the hydrophone.

The 8-way Subconn Micro series connector is connected to the Aquarius canister.

## 4.12 Connectors on the Aquarius canister

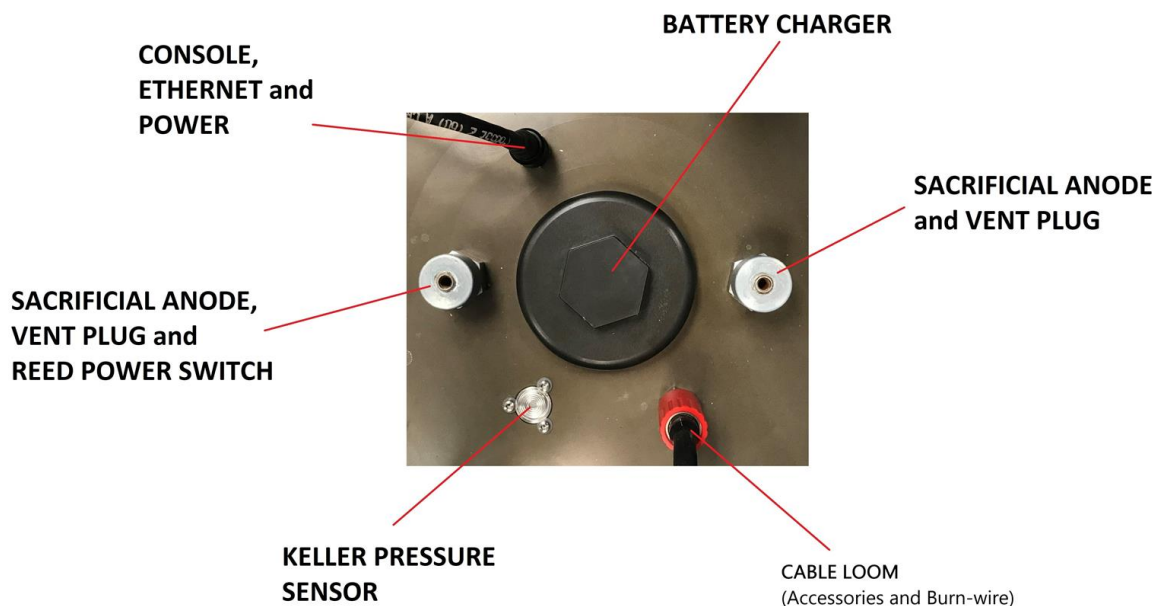

On the top half of the Aquarius canister the end user can identify the following parts:

- **Battery charger port:** used to recharge the Lithium-ion batteries housed inside the canister before any deployment (see Section 12.3 on page **Error! Bookmark not defined.**).
- **Cable Loom:** used to power and communicate with the APG sensor or Hydrophone, and to activate the Burn-Wire (see Section 12.1 on page **Error! Bookmark not defined.**).
- **Keller pressure sensor.**
- **Console, Ethernet and Power connector:** used to connect to the ULPD and LPC consoles, to access the LPC webpage and other functionalities via Ethernet and to eventually power up the system using an ROV compatible marine cable (see Section 12.2 on page **Error! Bookmark not defined.**).
- **Sacrificial anode and vent plug.**
- **Reed power switch:** used to power off the system with an off plug during periods of storage and transport.

The system should be powered off using the off plug when it is not used to ensure the batteries are not drained while the unit is being transported or if the unit is put into storage for any length of time. The plug can also be used to reset the unit.



**Note:** The batteries can be charged when the off plug is inserted and the system powered off.



**Note:** The reed switch connector is located between the Keller pressure sensor and the Seacon connector the underwater cable loom.

## 4.13 Lifting frame

For deployment and recovery the Aquarius can be lifted using the stainless steel frame shown in the picture on the side.

The frame is attached to the top of four stainless steel rods. On the bottom side, the rods are attached to the flange of the Aquarius aluminium pressure canister.

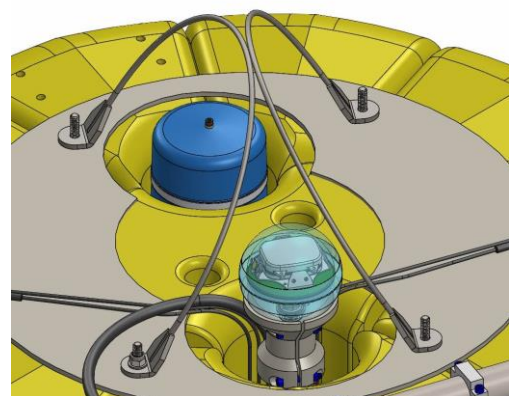

## 5 Battery changing

### 5.1 Charger box

The charger unit has been designed in conjunction with the OBS battery packs, so that it can charge the batteries in the shortest time possible. As mentioned in Section 4.5 on page 15, there are 12 x 1S battery packs in the OBS and, for the charging, they are connected as three packs with 4S configuration. Each 4S pack has its own charger circuit, this allows to charge all cells in the Aquarius in a third of the time. The chargers monitor temperature, voltage and current of each 1S battery pack during the charging cycle.

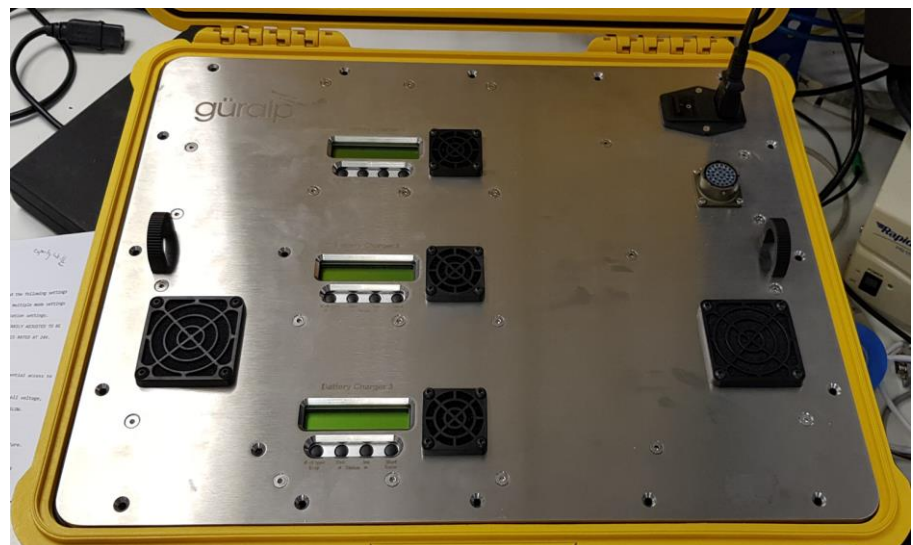

## Aquarius Ocean Bottom System

Therefore, three battery chargers were installed in the charger unit, all three are connected to the OBS unit through the same cable described in Section 5.3 on page 23. The charger unit voltage input is 85V to 230V AC.

Each of the chargers is equipped with a display and 4 control buttons:

- Batt type / Stop
- Dec / Status Decrement
- Inc / Status Increment
- Start / Enter



The charger unit is built into a Peli case so when properly sealed it is fully waterproof (IP67).



**Warning:** The charger unit is not waterproof when the lid is open. To dissipate the heat generated during the charging process, the unit was designed with ventilation fans and an outlet port.

Do not allow water into the unit when the lid is open.

## 5.2 Batteries charging specifications

| Parameter                            | Value |
|--------------------------------------|-------|
| Batteries arrangement                | 4S    |
| Nominal voltage per cell             | 4.2V  |
| Maximum charging voltage per 4S pack | 16.8V |
| Max charging current                 | 15A   |

## 5.3 Charging cable

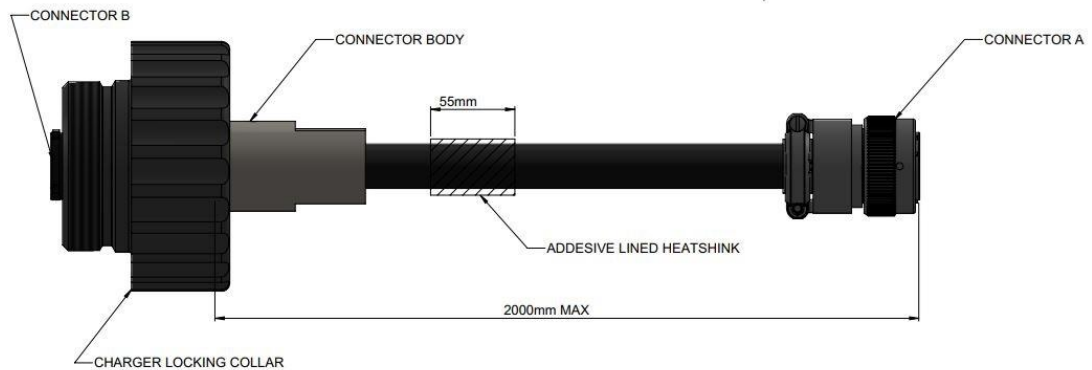

A 2.5 m charging cable, specifically designed for charging the Aquarius has been provided with the system. The cable has a 32-way Mil-Spec connector on both ends, socket on the Aquarius canister side and plug on the charger unit side.

For details about the pin-out see Section 12.3 on page **Error! Bookmark not defined..**

The cable has a locking collar on the Aquarius end. When this is screwed down with the O-ring in place, the Aquarius canister will still be waterproof, allowing charge of the OBS under rain or sea salt sprays.

As warned in the previous paragraph, the charger unit will need to be sheltered while charging.

## 5.4 Charging the batteries

### 5.4.1 Connecting the charger

Using the special tool provided, undo and remove the cap in the centre of the OBS to reveal the charging connector.



**Caution:** It is important to use the tool provided to avoid damage to the protecting finish on the cap and cause corrosion.



The cable connector with the large black ring connects to the OBS canister. Check the alignment as the connector is pushed in and tightened by hand.

---

## 5.4.2 Operating the charger unit

Batteries should be charged according to the following steps:

1. Connect the cable as described in Section 5.4.1 on page **Error! Bookmark not defined.**
2. Power up the charger box using the IEC C13 mains power cable and press the  switch.
3. In each of the chargers, press the "Batt type" button under the battery charger display. "PROGRAM SELECT Lithium Battery" is displayed on the LCD.
4. Press "Start/Enter" button once and use the "Dec" and "Inc" buttons to move across the program types until "FAST CHARGE" appears.
5. Press the "Start/Enter" button and use the "Dec" and "Inc" buttons to move across the battery types until "LiPo" (Lithium Polymer) appears.
6. Press the "Start/Enter" button and use the "Dec" and "Inc" buttons to move across the current value until "15 A" is selected.
7. Press the "Start/Enter" button and use the "Dec" and "Inc" buttons to move across the voltage value until "16.8 V (4S)" is selected.
8. Press the "Start/Enter" button.
9. Press and hold the "Start/Enter" button until the charging starts.

The battery charger notifies with a "beep" when the batteries are charged and shows the message "DONE" on the display, this will happen when the current reaches 3 A ( $\frac{1}{5}$  of charging current equal to 15 A).

Push on the "Stop" button to interrupt the charging if required.



**Note:** Points 3 to 8 of the procedure above is required only if the battery charger loses its configuration. When the charger is switched off it maintains the configuration. Before shipment, the chargers were programmed with the correct settings. If no changes were applied to the original settings, you could execute steps 1 and 2 and then jump to step 9.

The complete user manual the battery charger is available at the link below

<https://www.icharger.co.nz/assets/brochures/I208b.pdf>



## 6 Deck unit and surface dunker

### 6.1 Deck unit block diagram

The core of the deck unit is a Single Board Computer, powered by a large lithium ion battery pack capable of supporting deck operations for multiple hours to days, depending on usage. The computer has two LAN interfaces. One is dedicated to the Aquarius connection and has a DHCP server available that will provide to the OBS an I.P. address. A PoE injector allows to provide power to the Aquarius from the deck unit on the same Ethernet port. This will also be used to reboot the LPC in normal power mode, with the LAN interface on. The other LAN interface is dedicated to connections to the external world.

A PTP server is installed inside the deck unit for time synchronization of the Aquarius prior to deployments.

The SBC is also connected to the ULPD and LPC serial consoles and drives the surface acoustic dunker using other two RS-232 connections, one for the Command line of the modem, one for the Data line of the modem.

The deck unit is waterproof and having a large battery pack allows to work on deck, also in rough conditions, without the use of any mains, increasing the safety of the operators.

### 6.2 Side connectors panel

The deck unit right panel contains all the connectors arranged as below



Starting from left, the connectors functions are

- **Power in:** input voltage 90-305V AC, 43-63Hz.
- **GPS Antenna:** connect RF cable to the PTP server's GNSS receiver.
- **Dunker:** connect cable to the two serials of the acoustic Dunker, when used.
- **Aquarius Ethernet:** Ethernet cable to Aquarius. PoE can be turned on and off only on this port.

- **Aquarius RS-232:** serial connections to the Aquarius ULPD and LPC consoles.
- **Ethernet:** connection to external LAN.

## 6.3 Connect to the ULPD and to the LPC consoles

Connect a computer or the Güralp deck unit to the Aquarius Ethernet and RS-232 connector (see Section 12.2 on page **Error! Bookmark not defined.**) using the provided cable.

A connection is then made using a terminal emulator, such as minicom under Linux or PuTTY under Windows. The appropriate COM/USB port should be entered as the "Serial line", and the "Speed" should be set to 115200 (baud rate).

Two COM/USB ports are used, one to connect to the ULPD console and one to the LPC.

```

/dev/ttyUSB2 - PuTTY
2351,83 {sonardyne,c:1278} sonardyne_tx_serializer: <MDFT
2462,24 {sonardyne,c:777} sonardyne_rx_parser: 0x21A98950, start_idx = 11052, p
tr_to_cr = 0x21A9B4CB, sonardyne_state = 7
2462,25 {sonardyne,c:786} sonardyne_rx_parser: >[Processed telemetry packet typ
e 4[XC72,SNR77,DBV-3,TEL:TCS1:RPSKV2_200,FEC0]]
2521,31 {sonardyne,c:777} sonardyne_rx_parser: 0x21A98950, start_idx = 11132, p
tr_to_cr = 0x21A9B51F, sonardyne_state = 7
2521,32 {sonardyne,c:786} sonardyne_rx_parser: >[Processed telemetry packet typ
e 4[XC71,SNR77,DBV-3,TEL:TCS1:RPSKV2_200,FEC0:0:0]]
2583,41 {sonardyne,c:777} sonardyne_rx_parser: 0x21A98950, start_idx = 11216, p
tr_to_cr = 0x21A9B543, sonardyne_state = 7
2583,42 {sonardyne,c:786} sonardyne_rx_parser: >[MOD:Started Slave Modem Transf
er]
2583,43 {sonardyne,c:777} sonardyne_rx_parser: 0x21A98950, start_idx = 11252, p
tr_to_cr = 0x21A9B59E, sonardyne_state = 263
2583,44 {sonardyne,c:786} sonardyne_rx_parser: >[MOD:RX:15,FROM:5608[XC69,SNR77
,DBV-3,TEL:TCS2:RPSKV2_100,FEC0:0:0:0:0:0],MY_ACKS:8000]
2583,46 {sonardyne,c:777} sonardyne_rx_parser: 0x21A98950, start_idx = 11343, p
tr_to_cr = 0x21A9B595, sonardyne_state = 263
2583,47 {sonardyne,c:786} sonardyne_rx_parser: >[MOD:STATUS:16,ID:14]
2583,48 {sonardyne,c:777} sonardyne_rx_parser: 0x21A98950, start_idx = 11366, p
tr_to_cr = 0x21A9B5C9, sonardyne_state = 263
2583,49 {sonardyne,c:786} sonardyne_rx_parser: >[MOD:MY_ACKS:9000]
2583,50 {sonardyne,c:777} sonardyne_rx_parser: 0x21A98950, start_idx = 11386, p
tr_to_cr = 0x21A9B626, sonardyne_state = 263
2583,51 {sonardyne,c:786} sonardyne_rx_parser: >[Processed telemetry packet typ
e 13[XC69,SNR77,DBV-3,TEL:TCS2:RPSKV2_100,FEC0:0:0:0:0:0]]
2583,52 {sonardyne,c:726} sonardyne_rx_parser: received frame 0x01 0x00 0x00 0x
03 0x3B38, 0x3B38
2583,53 {sonardyne,c:1108} sonardyne_rx_worker: incoming_frames_tail = 20, inco
ming_frames_head = 21
sending undeplog 73
2583,71 {sonardyne,c:1311} sonardyne_tx_serializer: outgoing_frames_tail = 87,
outgoing_frames_head = 88
2583,72 {sonardyne,c:777} sonardyne_rx_parser: 0x21A98950, start
_idx = 11485, ptr_to_cr = 0x21A9B64A, sonardyne_state = 263
2583,73 {sonardyne,c:786} sonardyne_rx_parser: >MDFT:BUSY,QUEUED:27,MDR5608
yne,c:786} sonardyne_rx_parser: >MDFT:BUSY,QUEUED:27,MDR5608
ptr_to_cr = 0x21A9B64A, sonardyn2584,90 {sonardyne,c:777} sonardyne_rx_parser:
0x21A98950, start_idx = 11515, ptr_to_cr = 0x21A9B65C, sonardyne_state = 263
2584,31 {sonardyne,c:786} sonardyne_rx_parser: >[MOD:TX:15:HOST0]
2588,16 {sonardyne,c:777} sonardyne_rx_parser: 0x21A98950, start_idx = 11533, p
tr_to_cr = 0x21A9B639, sonardyne_state = 263
2588,17 {sonardyne,c:786} sonardyne_rx_parser: >[MOD:DONE]
2588,37 {sonardyne,c:1277} sonardyne_tx_serializer: SONARDYNE_OPCODE_TX_CMD, ou
tgoing_frames_tail = 88, outgoing_frames_head = 89
2588,2588,38 {sonardyne,c:777} sonardyne_rx_parser: 0x21A98950, start_idx = 115
45, ptr_to_cr = 0x21A9B690, sonardyne_state = 7
2588,39 {sonardyne,c:786} sonardyne_rx_parser: >MDFT:QUEUED:0,MDR5608
39 {sonardyne,c:786} sonardyne_rx_parser: >MDFT:QUEUE]

/dev/ttyUSB0 - PuTTY
gitting time: Minimus:15c36a8c 4693f000 Fentonus:15c36a8c 4926e890 err:-6 m
s ->Med Sep 11 15:04:06 2019
gitting time: Minimus:15c36a8c 84244600 Fentonus:15c36a8c 85c8b880 err:-6 m
s ->Med Sep 11 15:04:07 2019
gitting time: Minimus:15c36a8c bfbf1000 Fentonus:15c36a8c bf638280 err:-6 m
s ->Med Sep 11 15:04:08 2019
gitting time: Minimus:15c36a8c fb93da00 Fentonus:15c36a8c fafe4c80 err:-6 m
s ->Med Sep 11 15:04:09 2019
gitting time: Minimus:15c36a8d 36f4a400 Fentonus:15c36a8d 36931680 err:-6 m
s ->Med Sep 11 15:04:10 2019
gitting time: Minimus:15c36a8d 728f6e00 Fentonus:15c36a8d 7235e080 err:-6 m
s ->Med Sep 11 15:04:11 2019
gitting time: Minimus:15c36a8d ae2a3800 Fentonus:15c36a8d adceaa80 err:-6 m
s ->Med Sep 11 15:04:12 2019
gitting time: Minimus:15c36a8d e9c50200 Fentonus:15c36a8d ed854fc0 err:-63 m
s ->Med Sep 11 15:04:13 2019
gitting time: Minimus:15c36a8e 255fcc00 Fentonus:15c36a8e 25043e80 err:-6 m
s ->Med Sep 11 15:04:14 2019
gitting time: Minimus:15c36a8e 60fa3600 Fentonus:15c36a8e 609f0880 err:-6 m
s ->Med Sep 11 15:04:15 2019
gitting time: Minimus:15c36a8e 9c956000 Fentonus:15c36a8e 9c39d280 err:-6 m
s ->Med Sep 11 15:04:16 2019
gitting time: Minimus:15c36a8e d8302a00 Fentonus:15c36a8e d7d49c80 err:-6 m
s ->Med Sep 11 15:04:17 2019
gitting time: Minimus:15c36a8f 13caf400 Fentonus:15c36a8f 136ff680 err:-6 m
s ->Med Sep 11 15:04:18 2019
gitting time: Minimus:15c36a8f 4f65be00 Fentonus:15c36a8f 4f0a3080 err:-6 m
s ->Med Sep 11 15:04:19 2019
gitting time: Minimus:15c36a8f 8b008800 Fentonus:15c36a8f 8aa4fa80 err:-6 m
s ->Med Sep 11 15:04:20 2019
gitting time: Minimus:15c36a8f c69b5200 Fentonus:15c36a8f c770f180 err:-14 m
s ->Med Sep 11 15:04:21 2019
gitting time: Minimus:15c36a90 02361c00 Fentonus:15c36a90 01da8e80 err:-6 m
s ->Med Sep 11 15:04:22 2019
Undeplog..
gitting time: Minimus:15c36a90 3dd0e600 Fentonus:15c36a90 3d755880 err:-6 m
s ->Med Sep 11 15:04:23 2019
gitting time: Minimus:15c36a90 796bb000 Fentonus:15c36a90 79102280 err:-6 m
s ->Med Sep 11 15:04:24 2019
gitting time: Minimus:15c36a90 b5067a00 Fentonus:15c36a90 b4aae8c0 err:-6 m
s ->Med Sep 11 15:04:25 2019
gitting time: Minimus:15c36a90 f0a14400 Fentonus:15c36a90 f045b680 err:-6 m
s ->Med Sep 11 15:04:26 2019
gitting time: Minimus:15c36a91 2c3c0e00 Fentonus:15c36a91 2be08080 err:-6 m
s ->Med Sep 11 15:04:27 2019
gitting time: Minimus:15c36a91 67d6d800 Fentonus:15c36a91 677b4a80 err:-6 m
s ->Med Sep 11 15:04:28 2019
gitting time: Minimus:15c36a91 a371a200 Fentonus:15c36a91 a3151480 err:-6 m
s ->Med Sep 11 15:04:29 2019
    
```

# 7 Configuration and Control

## 7.1 Configuration and Control through Discovery

### 7.1.1 How to connect to Aquarius



**Note: A manual entirely dedicated to Discovery is now available!** After downloading Discovery ([Güralp Support: Discovery Download Page \(guralp.com\)](http://guralp.com)) click on Help → Help → Discovery Manual. Please read the sections that mention the use of Discovery in conjunction to the Discovery manual.

To view live waveforms, to control and configure the Aquarius, you will need to use Güralp Discovery software provided with the unit.

Discovery will initially “listen” for connected instruments on your local network.

This mode can be refreshed by clicking the **Scan Locally** button or by pressing the

short-cut keys **Ctrl + L**. These features are identified below:

| Status | Label      | System  | Name     | Serial# | Firmware Ver | WAN Address   | LAN Address | Uptime        | Latitude | Longitude |
|--------|------------|---------|----------|---------|--------------|---------------|-------------|---------------|----------|-----------|
| 13     | TR1207-487 | Minimus | MDN-8657 | 34391   | 1.1-1022     | 89.213.16.113 | 10.30.0.65  | 7 days 19 Hrs | 51.3612  | -1.1640   |
| 14     | TR1204-484 | Minimus | MDN-8757 | 34647   | 1.1-1022     | 89.213.16.113 | 10.30.0.67  | 6 days 17 Hrs | 51.3612  | -1.1640   |
| 15     | TR1205-485 | Minimus | MDN-8857 | 34903   | 1.1-1022     | 89.213.16.113 | 10.30.0.40  | 7 days 19 Hrs | 0.0000   | 0.0000    |
| 16     | NO LABEL   | Minimus | MDN-9355 | 37717   | 1.1-1022     | 89.213.16.113 | 10.30.0.77  | 18:01:29      | 51.3612  | -1.1640   |
| 17     | NO LABEL   | Minimus | MDN-A957 | 43351   | 1.1-1022     | 89.213.16.113 | 10.30.0.131 | 7 days 19 Hrs | 51.3612  | -1.1640   |

You can add instruments to the list by right-clicking in the blank area and selecting "Add device" or choosing this option from the Edit menu:

## Aquarius Ocean Bottom System

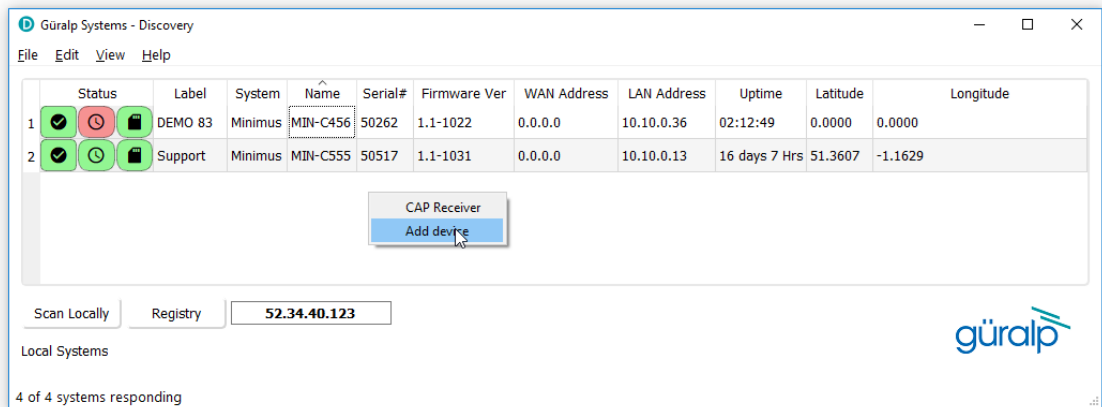

The following dialogue is displayed:

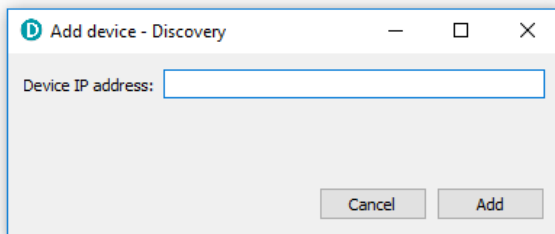

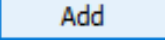
Enter the IP address of the Aquarius to be added and click the  button. The newly added device will appear in the device list.



**Note:** The newly added device will be removed from the list and not automatically re-added if a local network scan is performed.

You can choose which information is shown for each device in the main window. You can select which columns to display – and hide unwanted ones – by clicking on "Show" from the "View" menu.

# Aquarius Ocean Bottom System

| Item | Name              | Firmware Ver | WAN Address   | LAN Address     | Netmask         | Uptime         | Last Contact   | Latitude            | Longitude | Altitude  | Timing quality |     |
|------|-------------------|--------------|---------------|-----------------|-----------------|----------------|----------------|---------------------|-----------|-----------|----------------|-----|
| 1    | MIN-0957          | 1.2-8138     | 89.213.16.113 | 10.30.0.131     | 255.255.0.0     | 7 days 18 Hrs  | Just Now       | 51.3612             | -1.1640   | 105.20    | 100            |     |
| 2    | MIN-0558          | 1.1-1031     | 89.213.16.113 | 10.30.0.81      | 255.255.0.0     | 10 days 20 Hrs | Just Now       | 51.3612             | -1.1640   | 110.80    | 100            |     |
| 3    |                   | 4779         | 89.213.16.113 | 10.30.0.5       | 255.255.0.0     | 67 days 5 Hrs  | Just Now       | 0.0000              | 0.0000    | 0.00      | 100            |     |
| 4    | BGS string        | Minir        | -8560         | 89.213.16.113   | 10.30.0.92      | 255.255.0.0    | 2 days 19 Hrs  | Just Now            | 51.3612   | -1.1640   | 113.30         | 100 |
| 5    | BK64              | Minir        | -8563         | 169.229.12.201  | 172.18.8.64     | 255.255.255.0  | 11:07:10       | Just Now            | 37.8763   | -122.2355 | 211.10         | 0   |
| 6    | CVTG              | Minir        | -1022         | 201.191.198.155 | 192.168.0.100   | 255.255.255.0  | 02:48:19       | 2018-04-05T19:45:34 | 9.9381    | -84.0521  | 1206.19        | 100 |
| 7    | EAM2243           | EAM          | -15695        | 89.213.16.113   | 10.10.0.27      | 255.255.0.0    | 8 days 16 Hrs  | 2018-04-06T09:58:20 | 0.0000    | 0.0000    | 0.00           | 0   |
| 8    | EF00 Test         | Minir        | -1031         | 166.247.216.249 | 192.168.2.2     | 255.255.255.0  | 6 days 14 Hrs  | Just Now            | 29.1281   | -98.3803  | 171.00         | 100 |
| 9    | Eng_Test          | Minir        | -1022         | 89.213.16.113   | 10.30.0.58      | 255.255.0.0    | 2 days 23 Hrs  | Just Now            | 51.3611   | -1.1642   | 113.20         | 100 |
| 10   | Engineering Test  | Minir        | -8563         | 89.213.16.113   | 10.30.0.39      | 255.255.0.0    | 22:13:05       | Just Now            | 0.0000    | 0.0000    | 0.00           | 0   |
| 11   | GSL Minimus       | Minir        | -8562         | 62.49.27.35     | 192.168.254.246 | 255.255.255.0  | 1 days 19 Hrs  | Just Now            | 51.3613   | -1.1635   | 88.70          | 100 |
| 12   | HS                | Minir        | -1022         | 121.66.142.170  | 192.168.0.165   | 255.255.255.0  | 1 days 19 Hrs  | Just Now            | 36.3676   | 127.3194  | 80.90          | 100 |
| 13   | Horizontal Soak 2 | Minir        | -1022         | 89.213.16.113   | 10.20.0.86      | 255.255.0.0    | 8 days 23 Hrs  | Just Now            | 51.3610   | -1.1639   | 110.60         | 100 |
| 14   | Horizontal soak 1 | Minir        | -1022         | 89.213.16.113   | 10.20.0.232     | 255.255.0.0    | 14 days 0 Hrs  | Just Now            | 51.3611   | -1.1638   | 131.00         | 100 |
| 15   | IDL               | Minir        | -1022         | 194.117.40.80   | 10.101.80.77    | 255.255.255.0  | 91 days 15 Hrs | Just Now            | 38.7569   | -9.1567   | 91.70          | 100 |
| 16   | Murray            | Minir        | -8574         | 89.213.16.113   | 10.30.0.14      | 255.255.0.0    | 16:13:09       | Just Now            | 51.3611   | -1.1642   | 111.20         | 100 |
| 17   | NO LABEL          | Minir        | -8555         | 89.213.16.113   | 10.20.0.88      | 255.255.0.0    | 00:08:50       | Just Now            | 51.3609   | -1.1634   | 108.70         | 0   |

The "Status" column is composed of three icons that represent the Aquarius connectivity status (whether Aquarius is reachable/active or not), timing status (GNSS or PTP) and storage status (primary/secondary) respectively.

Hovering the mouse over any of these three icons will display tool-tips giving a brief description of the status including, for the timing indicator, details of which timing subsystems are operating:

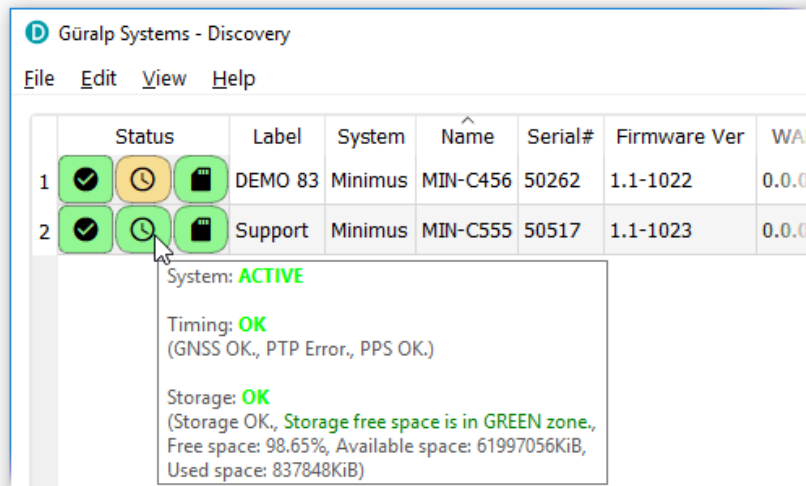

The seabed unit (Aquarius) is identified with System type "Aquarius" and Name "AQU-XXXXXX".

## Aquarius Ocean Bottom System

Right-clicking on the Aquarius row in Discovery allows to access all the functionalities, including the web interface, “LiveView” and “OBS Command & Control”.

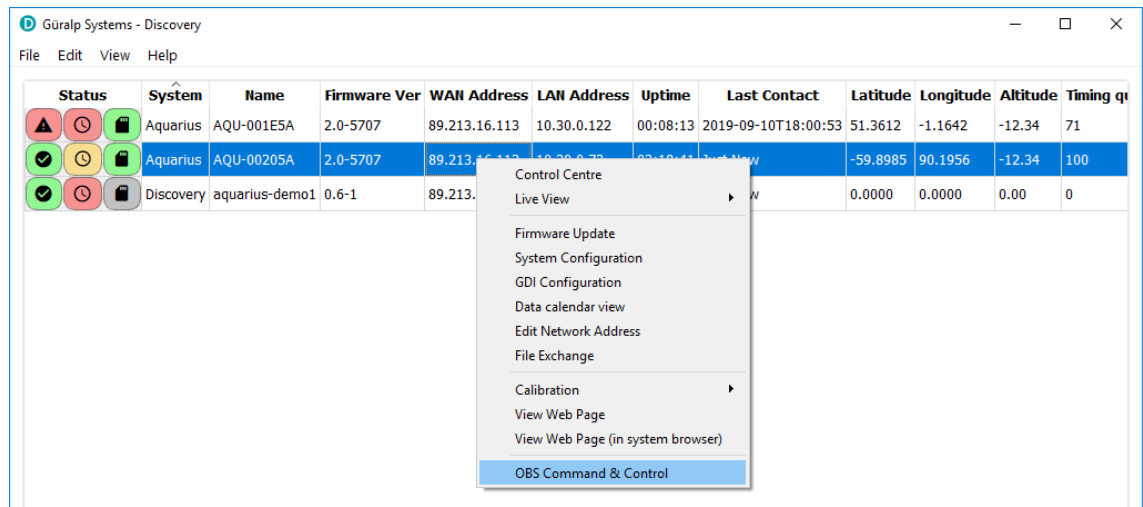

### 7.1.2 Live view

Discovery offers a versatile live waveform/data viewer. To open the Viewer, in Discovery's main window, select an instrument, right-click on it and select “Live View”.

The menu will then present three options for data streaming:

- GDI and GCF channels
- GDI only
- GCF only

The GCF option uses the Scream! Protocol to stream data in GCF packets. The GDI protocol streams data sample-by-sample and also allows the sending of each instrument's calibration parameters so that data can be expressed in terms of physical units rather than digitiser counts.

Güralp recommends using the “GDI only” option for waveform viewing.

The main features of – and the key buttons within – the Live View window are shown in the following screen-shot. Basic amplitude and time zoom functions are given in the Window zoom controls panel and streams can be easily added to or removed from the window by using the check-boxes in the left panel.

## Aquarius Ocean Bottom System

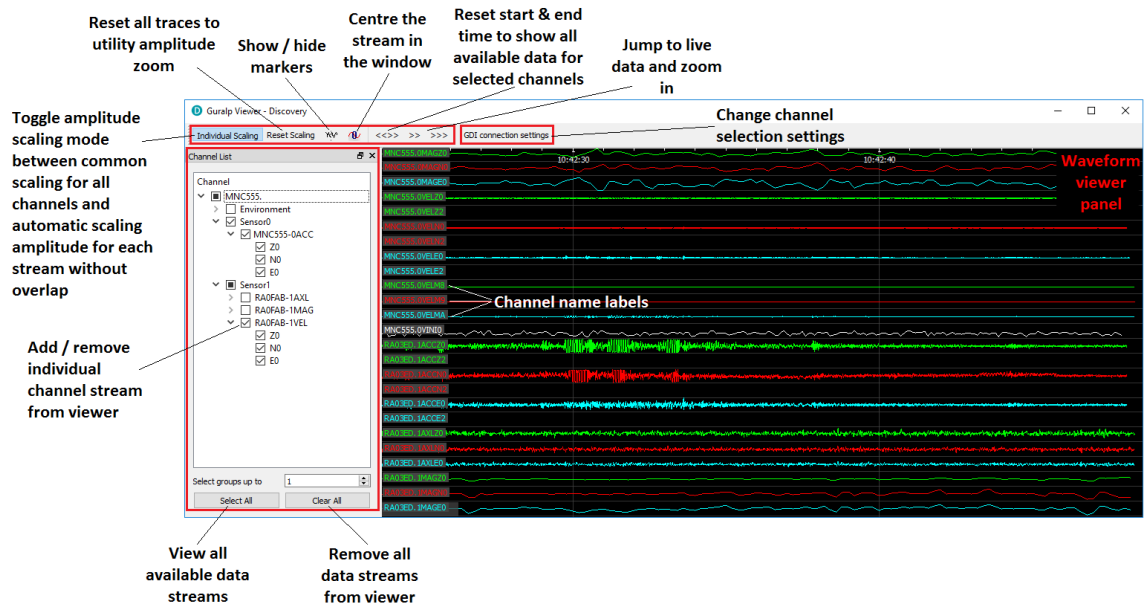

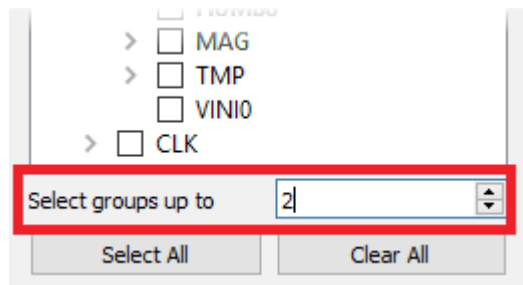

The channels are divided in groups with different hierarchical importance. The most important are the velocity/acceleration channels with higher sample rates: these belong to group 1. The least important belong to group 6, which includes humidity, temperature, clock diagnostics *etc.* When the live view is launched, only the channels in group 1 are selected. It is possible to change this setting by selecting a different group number from the “Select group up to” box at the bottom of the channel list.



When only few channels are selected for viewing, the channel name labels also show data statistics, including the maximum, minimum and average amplitudes in physical units.

If too many channels are in view for this information to be visible, you can left-click on a label and the label and trace will then expand to half the height of the screen, revealing these statistics. The other channels will be compressed into the remaining space. Another left-click on the same channel will return the window to normal. Alternatively, a left-click on a different channel will shrink the original one and expand the newly-selected one.

By selecting and dragging the mouse over a window of waveform data, the viewer will display similar statistics for the data within the selected window. When a window of data is selected, use the  key to subtract the ADC offset from the maximum, minimum and average values. Use the  key to calculate the integral

of the selected data. By right-clicking on the window, you can perform advanced analysis on the data, including plotting power spectral density graphs (PSDs), spectrograms and discrete Fourier transforms (DFTs), as shown below:

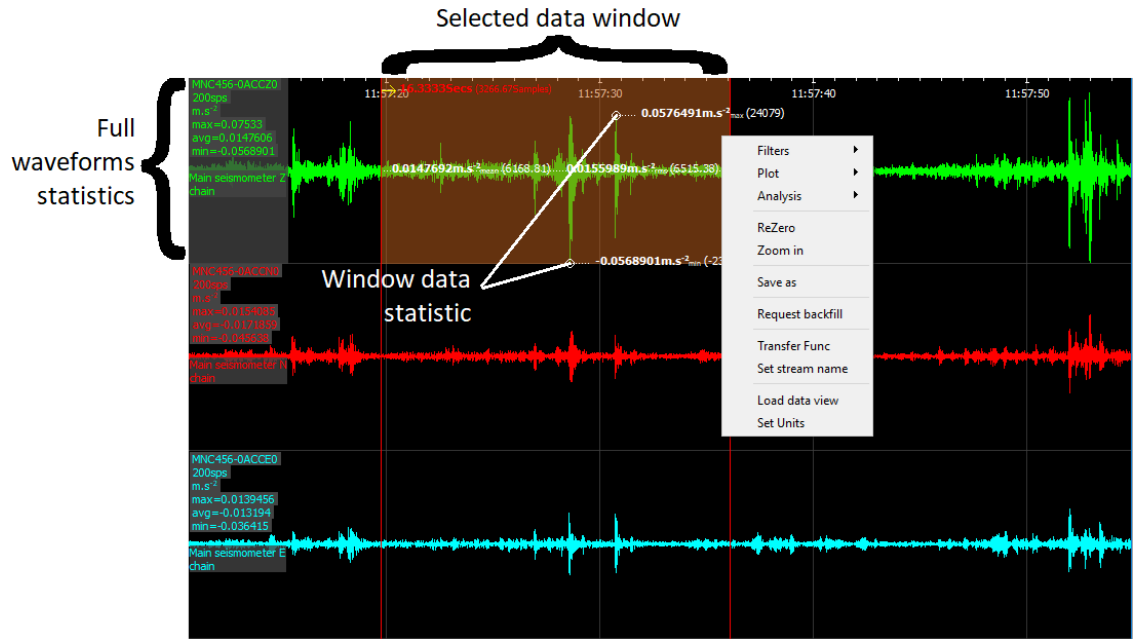



## Window control short-cuts

You can change the display of the waveforms with based on a combination of keystrokes and mouse-wheel scrolling (or track- / touch-pad scrolling on a laptop).

These commands are shown in the table below:

| Command                              | Window control                                  |
|--------------------------------------|---|
| <b><i>Amplitude control</i></b>      |   |
|                                      | Increase/decrease amplitude of all traces       |
| + hover cursor over channel label    | Increase/decrease amplitude of individual trace |
| +  + hover cursor over channel label | Shift individual trace offset up/down           |
| <b><i>Time control</i></b>           |   |
| +                                    | Pan time-scale right/left                       |
| +                                    | Zoom time-scale in/out                          |
| <b><i>Trace focus</i></b>            |   |



|   |  |
|---|--|
|  on trace label  | Focus on individual trace  |
| <b>Trace selection</b>  |  |
|  + hover cursor over on individual trace / trace label | Remove / de-select trace from Viewer window                                    |
| <b>Details control</b>  |  |
|  + hover cursor over on individual trace / trace label | Reset the maximum and minimum values to the average value of the selected data |

### 7.1.3 OBS Command & Control

This Discovery *OBS Command & Control* widget offers the end user a quicker way to go through the final steps of a pre-deployment procedure and allows to manage all the functionalities available through the acoustic communication, including the data retrieval and the ballast release.

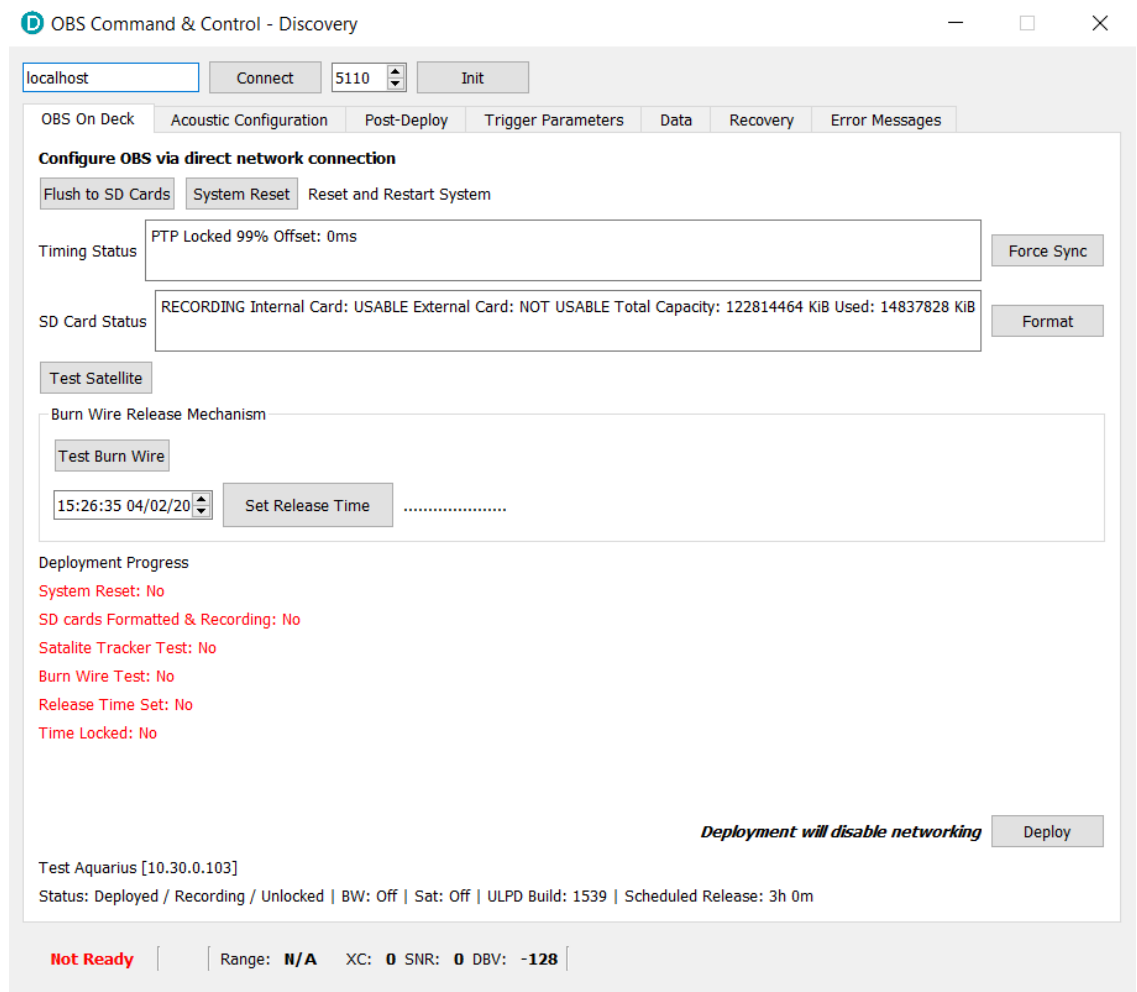

## Aquarius Ocean Bottom System

The bar at the top of *OBS Command & Control* configures the acoustic modem. The first address is device which hosts the acoustic modem. In most cases this will be the local machine.

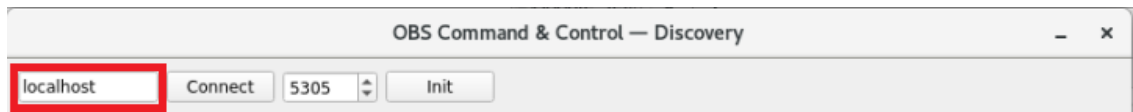

The second address is the one of the acoustic modem in the Aquarius (seabed unit).

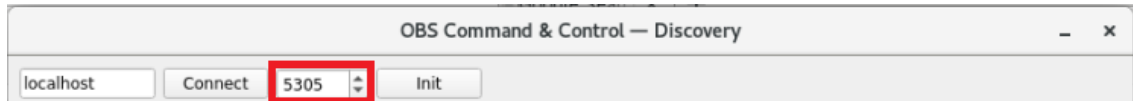



Click on “Connect” button to initiate the connection with the remote or local surface dunker driver and wait for the status at the bottom-left of the window to be **Ready**. After this, press the “Init” button. Only after these steps the end user can send commands through the surface acoustic dunker.

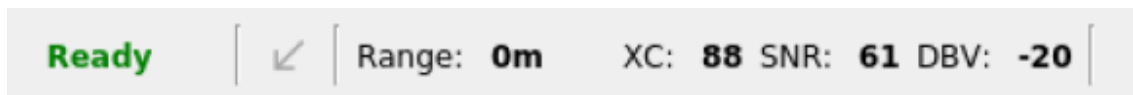

### 7.1.3.1 State of Health of the acoustic link

The “OBS Command & Control” shows the status of the acoustic link at the bottom window and it updates it every time an exchange of information with the modem occurs.



- Status: is the status of the acoustic communication and it can be **Ready**, **Busy**, **Not Ready** or **Network Error**.
- Arrow: indicates the direction of the communication (  bottom → surface or  surface → bottom).
- Range: is the slant range and it is calculated from the Turn-Around-Time.
- XC: Cross Correlation
- DBV: Degree of Voice Breaks.
- SNR: Signal to Noise Ratio.



**Note:** In certain situations (i.e. surface modem power cycle during acoustic activity), the status of the acoustic communication could get stuck in **Busy**. Click on the “Init” button, this operation should bring the status back to **Ready**.

### 7.1.3.2 OBS On Deck

The *OBS On Deck* tab of this widget connects to the Aquarius using the LAN. All the other tabs with acoustic functionalities utilise the acoustic modem connected to the Deck Unit.

OBS On Deck    Acoustic Configuration    Post-Deploy    Trigger Parameters    Data    Recovery    Error Messages

**Configure OBS via direct network connection**

Flush to SD Cards    System Reset    Reset and Restart System

Timing Status: PTP Locked 99% Offset: 0ms    Force Sync

SD Card Status: RECORDING Internal Card: USABLE External Card: NOT USABLE Total Capacity: 122814464 KiB Used: 14837828 KiB    Format

Test Satellite

Burn Wire Release Mechanism

Test Burn Wire

15:26:35 04/02/20    Set Release Time    .....

Deployment Progress

System Reset: No  
SD cards Formatted & Recording: No  
Satalite Tracker Test: No  
Burn Wire Test: No  
Release Time Set: No  
Time Locked: No

Deployment will disable networking    Deploy

Test Aquarius [10.30.0.103]  
Status: Deployed / Recording / Unlocked | BW: Off | Sat: Off | ULPD Build: 1539 | Scheduled Release: 3h 0m

### Flush to SD Cards

*Flush to SD Cards* instructs an immediate offload of any buffered data to be stored to SD card. This prevents the loss of data immediately before undeploying an Aquarius.

### System Reset

The ULPD can be reset to the “undeployed” state and the LPC rebooted pressing the *System Reset* button in the Pre-Deploy tab of the OBS Command & Control widget.

This button has the same effect as toggling the reed switch by screwing down and unscrewing the magnetic off plug.

Preparing the Aquarius to a deployment, click the “System Reset” button to start with a clean boot of both ULPD and LPC.

### Status Strings

“Timing Status” and “SD Card Status” should appear to indicate the PTP status and offset, and the some useful SD Card information.

*Force Sync* may be used during deployment to force the system time of the ULPD to PTP time. This should happen automatically when PTP lock has occurred.

A quick format of the SD cards can be performed pressing the *Format* button.

---

### Test Recovery Aids

The flashing LED beacons and satellite tracker may be switched on manually with the *Test Satellite* button.



Pressing this will cause the recovery aids to act as if the Aquarius has resurfaced: The LEDs will flash (as long as the ambient light level is low enough) and the satellite tracker will engage.

This feature should be switched off before deployment.

---

### Test Burn Wire

The *Test Burn Wire* button will energise the Burn Wire. This allows the user to check that a voltage is apparent across the Burn Wire electrodes before deployment.



Whilst in air, this will have no effect on the Burn Wire itself.

This should be turned off before deployment.

---

---

## Setting the timed Burn-Wire in the ULPD

As a back recovery option, a timed Burn Wire burn may be set.

Use the Date & Time input box to select the desired back-up Burn Wire release time, then use *Set Release Time* to send it to the Aquarius.

The screenshot shows a control panel titled "Burn Wire Release Mechanism". It contains a "Test Burn Wire" button with the status "Off". Below this is a date and time input field showing "17:26:35 04/02/20" with a dropdown arrow. To the right of the input field is a "Set Release Time" button. Further right, the text "Time until burn release: 3600 Seconds [1 Hours]" is displayed.

When the command is correctly sent, the widget shows the countdown in hours (or seconds if less than one hour).

---

## Deployment Progress List

Whilst not a replacement for the full deployment check-list found in this document, a reduced version is shown in the *OBS On Deck* widget to aid the user.

Each item in this list will turn green when the corresponding action has been carried out, or corresponding status becomes suitable for deployment.

### Deployment Progress

System Reset: Yes

SD cards Formatted & Recording: Yes

Satalite Tracker Test: Yes

Burn Wire Test: Yes

Release Time Set: Yes

Time Locked: Yes

Some of these steps may not be required for every deployment.

It is the users responsibility to confirm that the Aquarius is ready for deployment before it leaves a vessel.

---

## Deploy Button

Pressing the *Deploy* button will set the ULPD to a deployed state and switch off the LPC, therefore setting the Aquarius system into a deployed and recording state.

This will inherently prevent any further network communication with the Aquarius.

Loss of communication with the Aquarius following this procedure confirms the Aquarius as being in a deployed state.

---

## Aquarius System Status String

To provide further feedback as to the state of the system, a state of health/status string is provided in the *OBS On Deck* widget. This is automatically updated every few seconds to reflect the current state of the Aquarius system.

*Deployment will disable network*

Test Aquarius [10.30.0.103]

Status: Undeployed / Not-Recording / Locked | BW: Off | Sat: Off | ULPD Build: 1539 | Scheduled Release: 1h 0m

Above is an example of an Aquarius prior to deployment:

- It is undeployed
- It is not recording
- The internal clock is locked and external PTP time source
- The Burn Wire in not energised
- The Satellite tracking and LED beacon recovery aids are off
- The ULPD firmware version is 1539
- The Backup timed Burn Wire release is scheduled in roughly 1 hour

The user is not required to pay attention to this status string. It is provided for re-assurance.

Should network connectivity with the Aquarius be lost, this status string will disappear.

If this occurs following the user pressing the *Deploy* button, this is confirmation that the system is in a deployed state.

*Deployment will disable networking*

Deploy

Test Aquarius [10.30.0.103]

No Network Connection to Aquarius

---

### 7.1.3.3 Acoustic Modem Configuration

The *Acoustic Configuration* tab of “OBS Command & Control” allows the user to configure acoustic modems at both ends of the acoustic link.

Configuration of the local (surface) modem is performed via physical connection.

Configuration of the Remote (ocean bottom, deployed Aquarius) modem is performed over the acoustic link itself.

---

### Depth Configuration

Use the drop-down menu to select the depth range at which the OBS is deployed.

Click on *Local* → *Save & Send* to configure the acoustic modem attached to the deck-

## Aquarius Ocean Bottom System

unit or buoy unit via serial connection; click on *Remote* → *Send* to configure the acoustic modem inside the Aquarius via acoustic link.

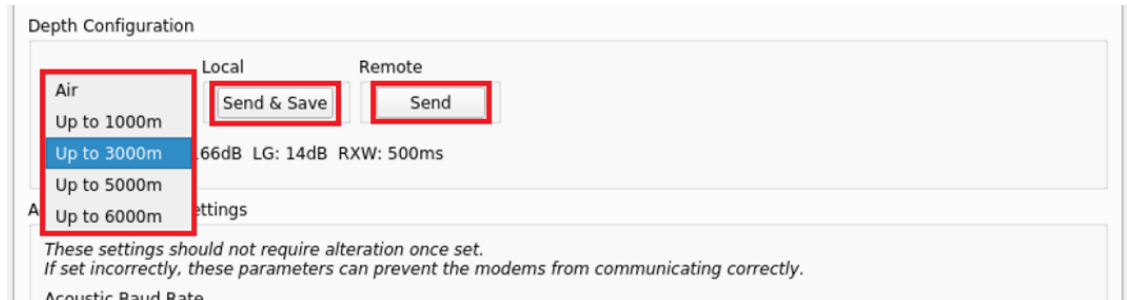

Depth Configuration

Air  
Up to 1000m  
Up to 3000m  
Up to 5000m  
Up to 6000m

Local: Send & Save  
Remote: Send

66dB LG: 14dB RXW: 500ms

Acoustic Baud Rate

*These settings should not require alteration once set.  
If set incorrectly, these parameters can prevent the modems from communicating correctly.*

## Acoustic Baud Rate

Use the drop-down menu to configure the acoustic modem transmission speed (baud rate). *Local* buttons are for the acoustic modem connected to the deck-unit, *Remote* ones for the acoustic modem in the Aquarius.

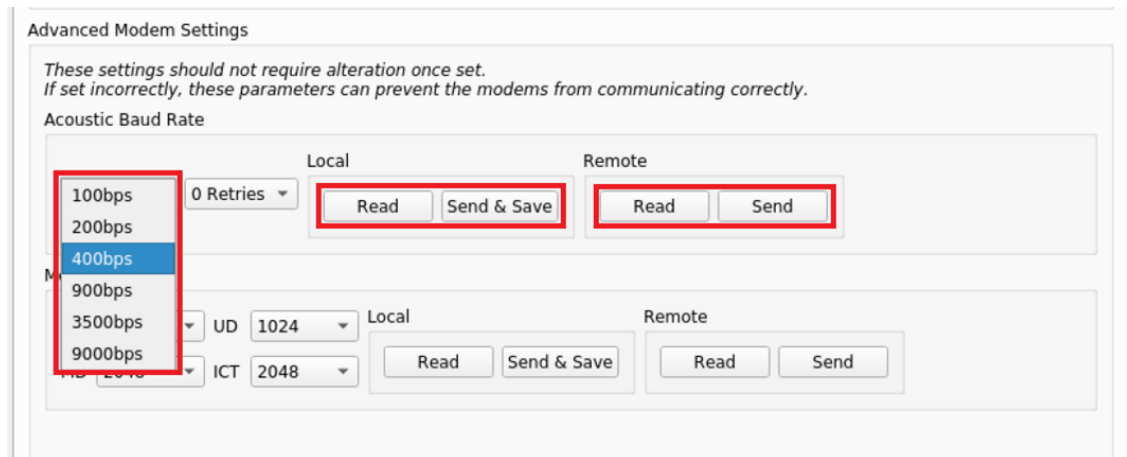

Advanced Modem Settings

*These settings should not require alteration once set.  
If set incorrectly, these parameters can prevent the modems from communicating correctly.*

Acoustic Baud Rate

Local: 0 Retries, Read, Send & Save  
Remote: Read, Send

UD: 1024, Local: Read, Send & Save, Remote: Read, Send  
ICT: 2048

The drop-down menu on the right in the *Acoustic Baud rate* section is used to set the “Master Retries” (*MR*). This parameter defines the number of times the master modem instrument will attempt to retrieve data that has been received in error. Only the data Sub Frames that were received in error are re-requested. Data Sub Frames will be pieced together automatically once they have all been received without errors. In a difficult acoustic environment this automatic re-request feature can be very powerful. However, it can result in latency in the data being delivered to the communications port.

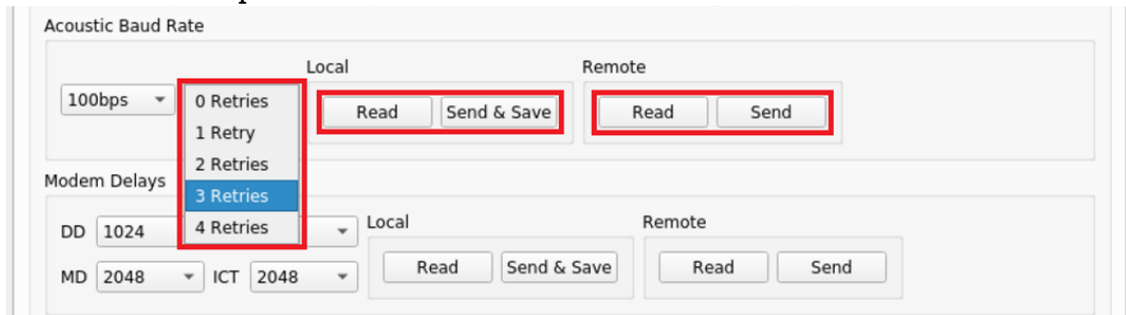

The “Modem Delays” parameters in the *Acoustic Configuration* tab are set at the factory and none of them should require alteration. In case of necessity, only an experienced user with guidance from Güralp should modify them. A detailed description of these parameters can be found in Section 15.1.1.2 on page 108.

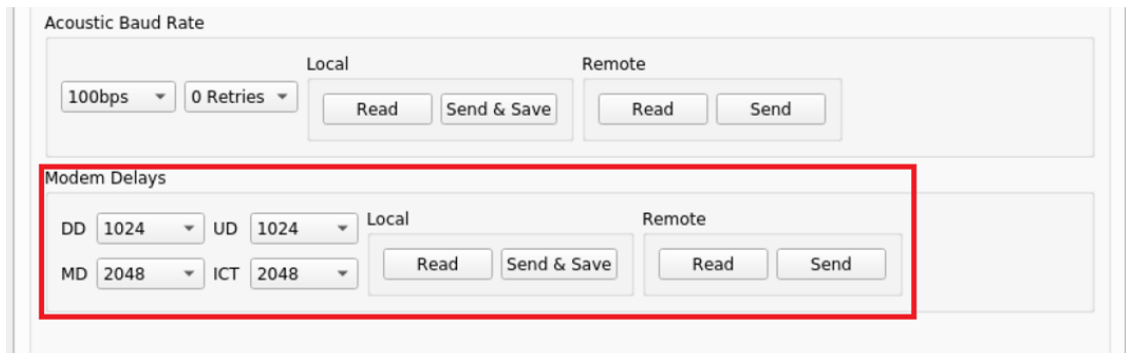

All changes in any of the remote modem parameters produced with the *Acoustic Configuration* tab can be saved, permanently, in non-volatile memory using the button *Save* at the bottom right corner of the window. If not saved, the changes will be lost at the next modem power cycle.

### 7.1.3.4 Post Deployment – Acoustic Interaction

The *Post-Deploy* tab of “OBS Command & Control” provides an interface for general configuration, control and status observation of an Aquarius via acoustic modem.

All operations in this widget require the acoustic modems to have been configured correctly.



# Aquarius Ocean Bottom System

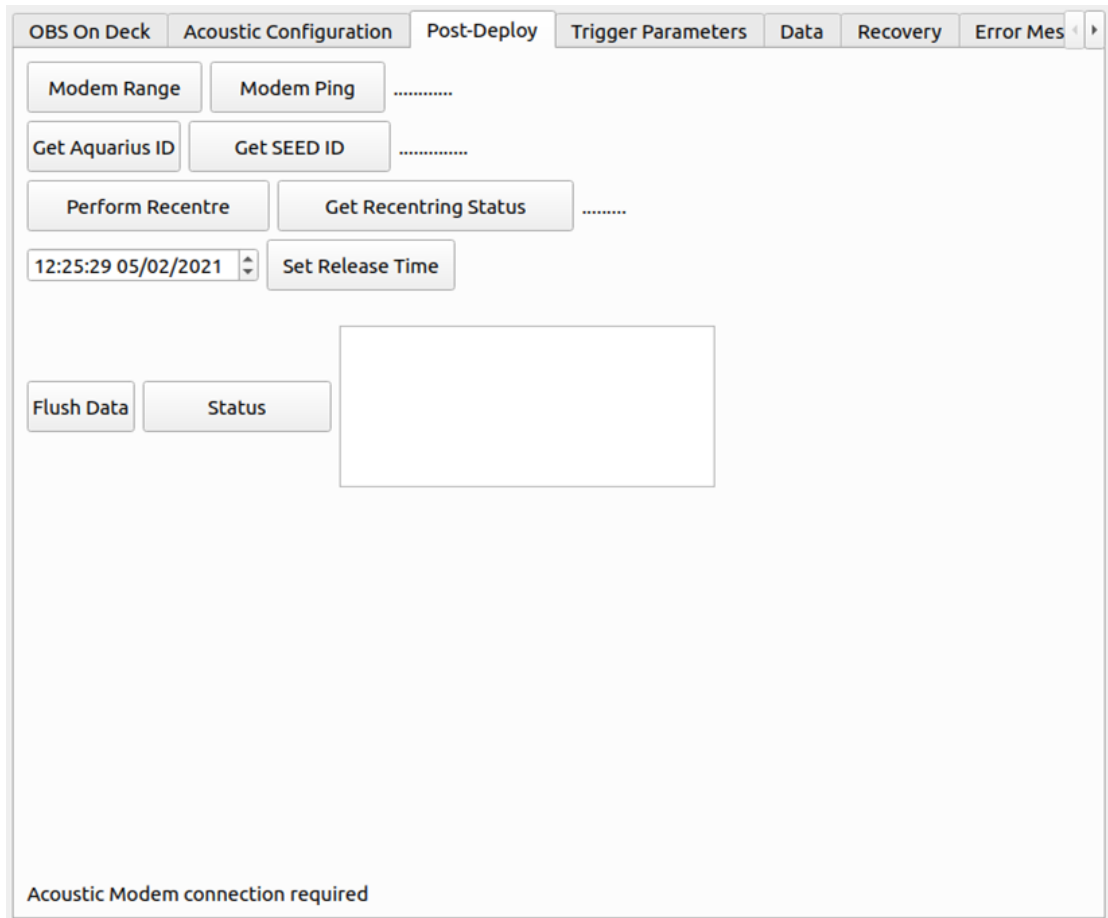

## Modem Range and Modem Ping

Two methods of making initial acoustic contact with a deployed Aquarius are available.

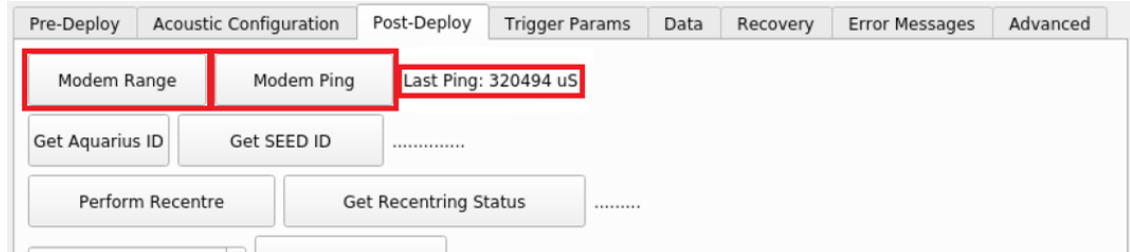

The *Modem Range* button is used to measure an individual range to a remote instrument. This is the shortest message that could be sent to the bottom modem, useful for diagnosing acoustic communication issues in challenging scenarios for the acoustic link, as explained in Section 15.3.1 on page **Error! Bookmark not defined.**

In the presence of a good acoustic link, *Modem Ping* may be used to verify the connection with the acoustic modem. The last ping in "uS" will be printed. This is the Turn-Around-Time reported by the acoustic modem.



**Note:** The Turn-Around-Time (TAT) is the time in milliseconds that the remote instrument takes to respond to an interrogation signal, starting from when the interrogation is sent until the acknowledgement is received.

## Get Aquarius ID and SEED ID

Further verification of the acoustic link with an Aquarius is available through the *Get Aquarius ID* and *Get SEED ID* buttons.

These interrogate the LPC (if awake) for the respective IDs, which will be displayed if received.

## Perform a Seismometer Centring

Click on *Perform Recentre* to start the centring of the main sensor's components. When centring is ongoing the status is Centring.

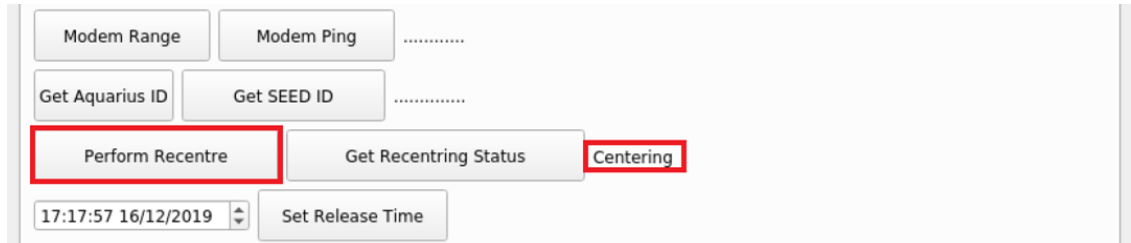

Click on *Get Recentring Status* to verify at what stage the centring is.



Z, N and E are the three components Vertical, N/S and E/W respectively.

- The first number indicates the status of the electrical centring (1 = centring, 0 = centred).
- The second number indicates the status of the mechanical centring (1 = centring, 0 = centred).



**Note:** The mechanical centring is the first stage and takes only a few seconds if the sensor is not moving. The electrical centring follows and takes around 10 minutes.

## Flush Data to the LPC

Click on *Flush Data* to flush data from the ULPD memory to the LPC microSD card. This operation is needed when the end user needs to retrieve last minutes data acoustically.

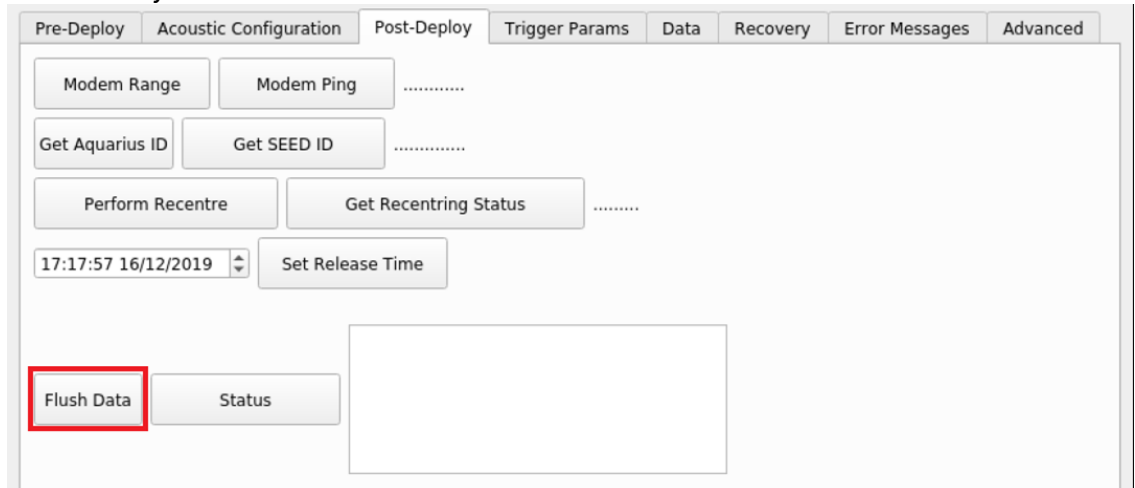

## Get Data with a certain timestamp

Once data is flushed into the LPC, the *Request OBS Data* window appears. Select the starting data and time and click on "Request Data" button to proceed.

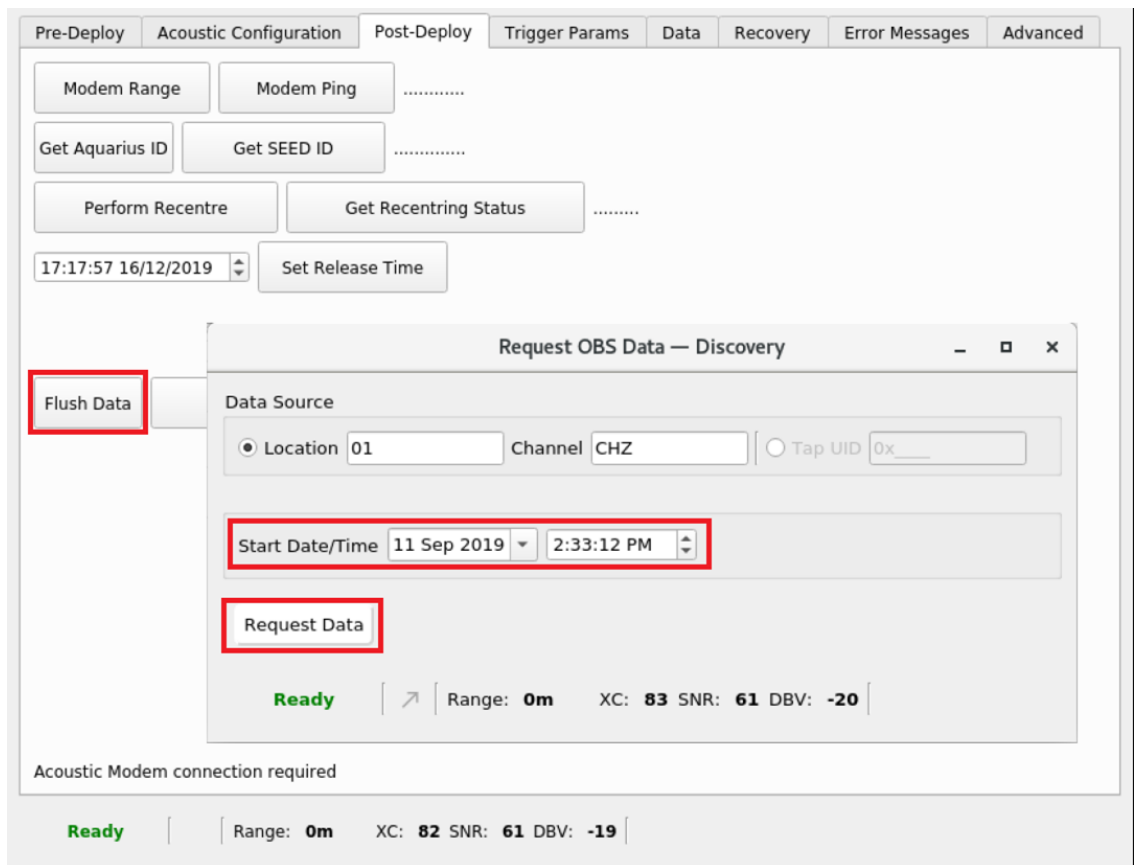

## Set timed Burn-Wire

In the Post-Deploy tab of “OBS Command & Control”, it is possible to update the Burn-Wire timer in the ULPD via acoustic commands. Select the date and time at which the Burn-Wire should be released. Once the time is configured, click on “Set Release Time” to send the command to the OBS via acoustic.

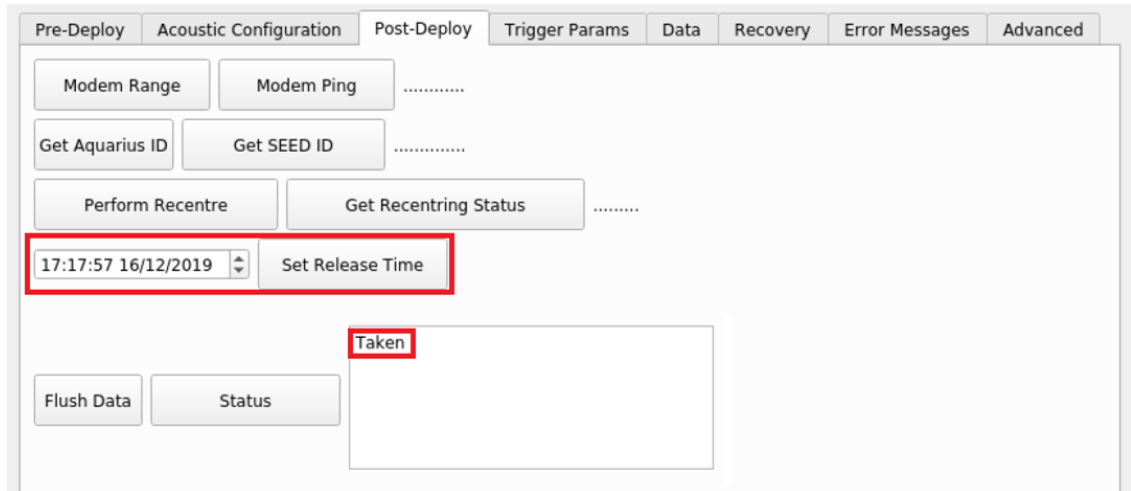

If the command is sent correctly the status notifies with the message “Taken”.

### 7.1.3.5 Recovery - Ballast Release

The *Recovery* tab of “OBS Command & Control” allows the user to recover a deployed Aquarius via the acoustic link.

To activate the Burn Wire and begin a recovery: Click on *Get the remote modem’s unique ID* to obtain the seabed modem hard-coded address.

Set the amount of time for the Burn Wire activation. 900 Seconds is adequate and further activations are possible.

## Aquarius Ocean Bottom System

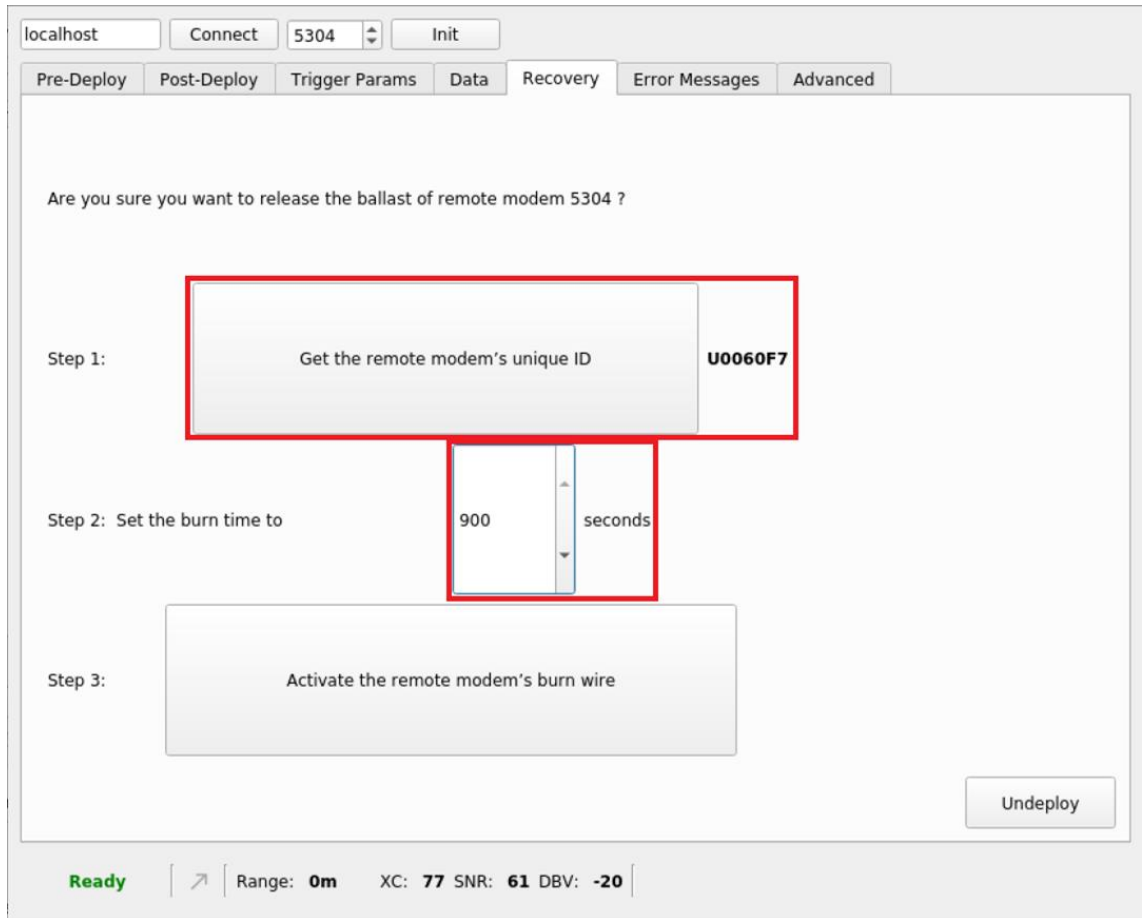

Finally, click on *Activate the remote modem's burn wire* button to send the command to the Aquarius via acoustic. Once the command is correctly sent, the countdown is showed on the window.



### 7.1.3.6 Error messages

In the *Error Messages* tab of "OBS Command & Control", errors that occur during the data retrieval via acoustic link are listed. This tool is useful to identify the cause of the issue.

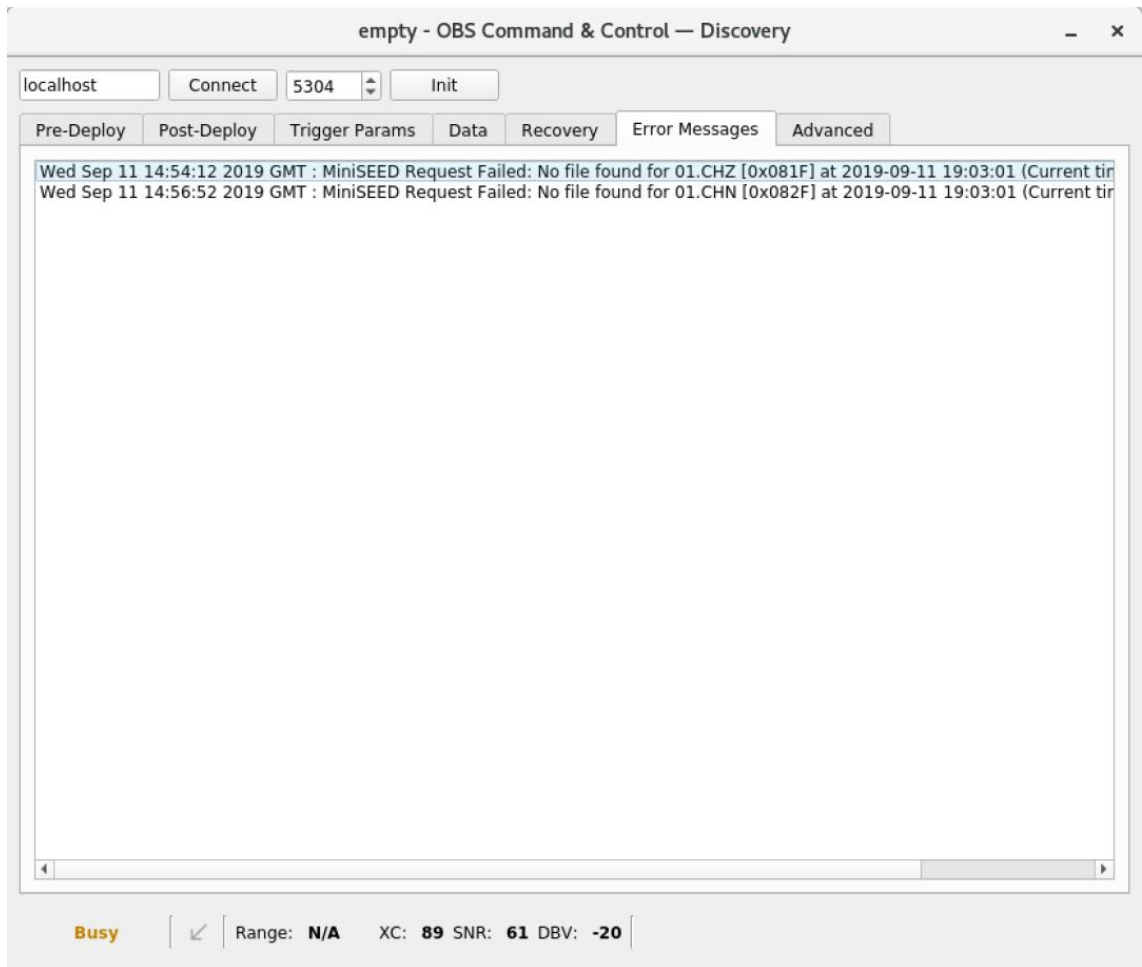

---

## 7.2 Configuration and Control through Web Interface

Discovery offers access to the Aquarius web interface for configuration and control of the instrument. To open the web page, in Discovery's main window, select an instrument, right-click on it and select "View Web Page" or "View Web Page (in system browser)".

---

### 7.2.1 Network configuration

Once the web page is open either in Discovery or web browser, navigate to the "Network" tab.

The LPC inside the Aquarius and the one-board computer in the deck-unit use DHCP (Dynamic Host Configuration Protocol) to acquire their network configuration.

The dynamically obtained I.P. address is listed in Discovery main window under "LAN Address" column.

## Aquarius Ocean Bottom System

| Status | System    | Name           | Firmware Ver | WAN Address   | LAN Address | Uptime   | Last Contact | Latitude | Longitude | Altitude | Timing |
|--------|-----------|----------------|--------------|---------------|-------------|----------|--------------|----------|-----------|----------|--------|
|        | Aquarius  | AQU-00205A     | 2.0-5707     | 89.213.16.113 | 10.30.0.73  | 03:13:31 | Just Now     | -59.8985 | 90.1956   | -12.34   | 100    |
|        | Discovery | aquarius-demo1 | 0.6-1        | 89.213.16.113 | 10.30.0.122 | 00:40:02 | Just Now     | 0.0000   | 0.0000    | 0.00     | 0      |

### 7.2.2 PTP

The Aquarius system supports timing provided through PTP when LAN is switched on.

The screenshot shows the Aquarius web interface with the 'Status' tab selected. The system information is as follows:

System type: Aquarius | Host label: DIAS-AQUARIUS | Host name: AQU-00205A (10.30.0.73) | Serial number: 00205A

| System Status              |                      |                                  |                      |                   |                       |                             |                   |
|----------------------------|----------------------|----------------------------------|----------------------|-------------------|-----------------------|-----------------------------|-------------------|
| General information        |                      |                                  |                      |                   |                       |                             |                   |
| Host name                  | AQU-00205A           | Host label                       | DIAS-AQUARIUS        | System type       | Aquarius              | Product type                | Aquarius          |
| Serial number              | 00205A               | Firmware version                 | 2.0-5707             | IPv4 address      | 10.30.0.73 (DHCP)     | SEED network and station    | DG.TEST (No site) |
| Digitiser temperature      | 29.212 °C            | Digitiser humidity               | 33.68%               | Input voltage     | 2.510 V               | Power over Ethernet voltage | 0.000 V           |
| Uptime                     | 3h 30m 47s           |                                  |                      |                   |                       |                             |                   |
| GNSS Status                |                      |                                  |                      |                   |                       |                             |                   |
| GNSS connection status     | Disconnected         | Last timestamp                   | 0000-00-00 00:00:00  |                   |                       |                             |                   |
| Last lock time             | Never                | GNSS stability                   | Disconnected         |                   |                       |                             |                   |
| Latitude                   | -59.899              | Longitude                        | 90.1957              |                   |                       |                             |                   |
| Altitude                   | -12.34               | Horizontal dilution of precision | Undefined            |                   |                       |                             |                   |
| GNSS PPS status            | Not Trusted No Pulse | GNSS NMEA stream                 | Bad input            |                   |                       |                             |                   |
| GNSS Lock state            | No lock              | Number of satellites             | Used: 0 In view: 0   |                   |                       |                             |                   |
| PTP Status                 |                      |                                  |                      |                   |                       |                             |                   |
| PTP state                  | Phase Locked         | Last PTP timestamp               | 2019-09-11 11:04:18Z |                   | Last PTP lock time    | 2019-09-11 11:02:30Z        |                   |
| Master IPv4 address        | 10.30.255.35         | Master clock class               | PRI_REF_PTP          |                   | Master clock accuracy | < 100ns (0x21)              |                   |
| Network path delay         | 32.7 us              | Network jitter estimate          | -                    |                   | Network outliers      | 1%                          |                   |
| Data record status         |                      |                                  |                      |                   |                       |                             |                   |
| microSD status             | Recording            | microSD total                    | 60686336 KiB         |                   | microSD used          | 67928 KiB                   |                   |
|                            |                      | microSD free                     | 99%                  |                   |                       |                             |                   |
| Sensors                    |                      |                                  |                      |                   |                       |                             |                   |
| Number of sensors detected | 2                    |                                  |                      |                   |                       |                             |                   |
| Sensor0                    |                      |                                  |                      | Sensor1           |                       |                             |                   |
| Serial number (0)          |                      |                                  |                      | Serial number (1) |                       |                             |                   |
| Integrator Z (0)           | 0                    |                                  |                      | Integrator N (0)  | 0                     |                             |                   |
| Seismometer Z (0)          | -5559061             |                                  |                      | Seismometer N (0) | 3261771               |                             |                   |
| Firmware ver (0)           | 0.1                  |                                  |                      | Firmware ver (1)  | 0.1                   |                             |                   |
| Integrator E (0)           | 0                    |                                  |                      | Temperature (1)   | 33.57 °C              |                             |                   |
| Seismometer E (0)          | 2680823              |                                  |                      | Yaw (1)           | 0.000°                |                             |                   |
| Integrator Z (1)           | -21691               |                                  |                      | Pitch (1)         | 0.000°                |                             |                   |
| Integrator N (1)           | 12752                |                                  |                      | Roll (1)          | 0.000°                |                             |                   |
| Integrator E (1)           | 10480                |                                  |                      | Seismometer Z (1) | -1080                 |                             |                   |
| Seismometer Z (1)          | -1080                |                                  |                      | Seismometer N (1) | -2936                 |                             |                   |
| Seismometer E (1)          | 28171                |                                  |                      | Seismometer E (1) | 28171                 |                             |                   |

The IEEE 1588 Precision Time Protocol is used to synchronise clocks across a computer network. It is significantly more accurate than NTP but generally requires specialised hardware support. PTP can be configured for multicast or unicast mode. In unicast mode, the server IP address must be specified.

This is available in the “Status” tab of the Aquarius web page. A number of reporting parameters are given, including:

- PTP state.



## Aquarius Ocean Bottom System

- Last PTP time-stamp and last PTP lock date/time.
- PTP Stability:
  - Standby  $\Rightarrow$  PTP is running but timing is provided by GNSS;
  - No Master  $\Rightarrow$  PTP not available;
  - 1-100%  $\Rightarrow$  PTP locking process indicator. 100% indicates a time accuracy of better than 200ns.
- Master IPv4 address.
- Master clock class and accuracy.
- Master time source.
- Network path delay.
- Network jitter estimate: quality indicator.
- Network outliers.

In the Aquarius PTP is the only source of timing available. To configure its settings, visit the “Network” tab in web page.

The screenshot shows the Aquarius web interface with the 'Network' tab selected. The 'Network Config' section includes settings for DHCP (Enabled), DNS1 (209.244.0.3), DNS2 (84.200.69.80), Web Login (Not Required), Username (admin), Password (masked), HTTP Port (80), SeedLink (Enabled, 65536 records), Send status.txt Every (300 seconds), SeedLink Data Packet Format (Optimal), TFTP Server (10.30.255.197), and TFTP File. The 'Network Timing' section includes PTP Mode (Run always - Override GPS), PTP Offset Correction (0 nanoseconds), PTP Transmission Mode (Multicast), NTP S (Disabled), Registry Address (52.34.40.123), and Group ID (obs-dev).

Under the heading “Network config” are four options:

- **Disabled**  $\Rightarrow$  PTP is never used (default settings).
- **Run if needed – Offline backup**  $\Rightarrow$  PTP is automatically enabled whenever the GNSS signal is lost. It is disabled while GNSS is available. This mode is used to minimise network traffic when GNSS is the primary timing source.
- **Run always – Online backup**  $\Rightarrow$  PTP is always running but GNSS is used as the primary timing source. This mode is useful for faster fall-back from GNSS to PTP timing and for validation that PTP is available.

- **Run always – Override GPS** = PTP is always running and takes priority over GNSS. This mode is useful in a system where PTP is the primary timing source, but GNSS may occasionally be connected for validation purposes.

Select the option **“Run always – Override GPS”** before the deployment of Aquarius OBS.

### 7.2.3 Setting up streamed data

The monitoring and configuration of transmitted data is handled using the “Data Stream” tab in the web page. Data streaming is only included for testing purposes prior to the deployment.

| Channel sampling rate              | Data transform | SEED name - please use check-box to modify the default | RESPonse file - if available  |
|------------------------------------|----------------|--|-------------------------------|
| <b>Seismic channels</b>            |                |  |                               |
| 1AUXX0                             | 100 Hz         | <input type="checkbox"/> DG.TEST,01 .HDF               | <a href="#">RESP file 54</a>  |
| 1VELZ0                             | 250 Hz         | <input type="checkbox"/> DG.TEST,01 .CHZ               | <a href="#">RESP file 57</a>  |
| 1VELN0                             | 250 Hz         | <input type="checkbox"/> DG.TEST,01 .CHN               | <a href="#">RESP file 62</a>  |
| 1VELE0                             | 250 Hz         | <input type="checkbox"/> DG.TEST,01 .CHE               | <a href="#">RESP file 67</a>  |
| 1VELZ2                             | 5 Hz           | <input type="checkbox"/> DG.TEST,01 .MHZ               | <a href="#">RESP file 58</a>  |
| 1VELN2                             | 5 Hz           | <input type="checkbox"/> DG.TEST,01 .MHN               | <a href="#">RESP file 63</a>  |
| 1VELE2                             | 5 Hz           | <input type="checkbox"/> DG.TEST,01 .MHE               | <a href="#">RESP file 68</a>  |
| <b>Mass position channels</b>      |                |  |                               |
| 1INTZ0                             | 5 Hz           | <input type="checkbox"/> DG.TEST,01 .MMZ               |                               |
| 1INTN0                             | 5 Hz           | <input type="checkbox"/> DG.TEST,01 .MMN               |                               |
| 1INTE0                             | 5 Hz           | <input type="checkbox"/> DG.TEST,01 .MME               |                               |
| <b>MEMS accelerometer channels</b> |                |  |                               |
| 1AXLZ0                             | 5 Hz           | <input type="checkbox"/> DG.TEST,01 .MNZ               | <a href="#">RESP file 87</a>  |
| 1AXLN0                             | 5 Hz           | <input type="checkbox"/> DG.TEST,01 .MNN               | <a href="#">RESP file 92</a>  |
| 1AXLE0                             | 5 Hz           | <input type="checkbox"/> DG.TEST,01 .MNE               | <a href="#">RESP file 97</a>  |
| <b>Magnetometer channels</b>       |                |  |                               |
| 1MAGZ0                             | 5 Hz           | <input type="checkbox"/> DG.TEST,01 .MFZ               | <a href="#">RESP file 102</a> |
| 1MAGN0                             | 5 Hz           | <input type="checkbox"/> DG.TEST,01 .MFN               | <a href="#">RESP file 105</a> |
| 1MAGE0                             | 5 Hz           | <input type="checkbox"/> DG.TEST,01 .MFE               | <a href="#">RESP file 108</a> |

This page allows to configure the transmitted channels for each of the connected sensors. The names and contents of each channel are described in Section 11.1 on page **Error! Bookmark not defined.**





**Note:** When changing a setting in the Aquarius web page, ensure that you wait until the page refreshes before changing another setting. This allows time for the previous change to take effect.

The drop-down box at the top-left of the page named “Display Streams” filters out visible channels among Enabled and Disabled. The option “Apply configuration for tap groups” automatically apply the same configuration to three streams that belong to the same tap, e.g. 1VELZ0, 1VELN0, 1VELE0. The drop-down box at the top-right of the page named “Display On Page” allows to move from different instruments, e.g. Sensor 1.



**Note:** The most relevant streams for the Aquarius are located on Sensor 1. Other sensor’s streams could be ignored by the end user.

The page is divided in four columns:

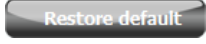
- in most-left column, drop-down boxes are available for each channel to either select a sample rate or to exclude the channel from streaming (by selecting the “Disabled” option). All streaming can be stopped by clicking the  button. Same configuration can be applied to recorded channels by clicking the  button. Default channel configuration can be applied by clicking the  button.
- second column from the left is not relevant for the Aquarius OBS;
- in third column from left, Location and Channel SEED codes can be configured. Cells are greyed out by default (default values applied) and they can be edited by clicking on the check-box;
- in most-right column contains links to the RESP files associated to each of the seismic channels (see Section 7.2.8 on page **Error! Bookmark not defined.**).

Upon changing the sample rate or changing Location and Channels codes, the Aquarius will need to be restarted for the changes to come into effect; this can be done by pressing the  button.

Once the Aquarius has successfully restarted, the full web browser display and controls will be available for use again.

## 7.2.4 Setting up recorded channels

The main panel of the "Data Record" tab in the web interface is shown here:

System type: Aquarius | Host label: DIAS-AQUARIUS | Host name: AQU-00205A (10.30.0.73) | Serial number: 00205A

**Data Record**

Buttons: Disable All, Restore default, Reboot, Copy to Data Stream, Copy FR to all

Recording status: **Recording**

Display Streams: Low Power Recording,  Apply configuration for tap groups, Display On Page: Sensor 1

**Channels configuration**

| Channel sampling rate               | Data transform                   | SEED name - please use check-box to modify the default | RESPonse file - if available  |
|-------------------------------------|----------------------------------|--|-------------------------------|
| <b>Seismic channels</b>             |                                  |  |                               |
| S1SeisXFR 100 Hz                    | Transforms Disabled for this tap | <input type="checkbox"/> DG.TEST,01 HDF                | <a href="#">RESP file 56</a>  |
| S1SeisZFR 250 Hz                    | Transforms Disabled for this tap | <input type="checkbox"/> DG.TEST,01 CHZ                | <a href="#">RESP file 61</a>  |
| S1SeisNFR 250 Hz                    | Transforms Disabled for this tap | <input type="checkbox"/> DG.TEST,01 CHN                | <a href="#">RESP file 66</a>  |
| S1SeisEFR 250 Hz                    | Transforms Disabled for this tap | <input type="checkbox"/> DG.TEST,01 CHE                | <a href="#">RESP file 71</a>  |
| <b>Mass position channels</b>       |                                  |  |                               |
| S1IntZFR 5 Hz                       | Transforms Disabled for this tap | <input type="checkbox"/> DG.TEST,01 MMZ                |                               |
| S1IntNFR 5 Hz                       | Transforms Disabled for this tap | <input type="checkbox"/> DG.TEST,01 MMN                |                               |
| S1IntEFR 5 Hz                       | Transforms Disabled for this tap | <input type="checkbox"/> DG.TEST,01 MME                |                               |
| <b>MEMS accelerometer channels</b>  |                                  |  |                               |
| <b>Magnetometer channels</b>        |                                  |  |                               |
| <b>Low latency seismic channels</b> |                                  |  |                               |
| <b>Auxiliary channels</b>           |                                  |  |                               |
| S1PresFR 5 Hz                       | Transforms Disabled for this tap | <input type="checkbox"/> DG.TEST,01 MDI                | <a href="#">RESP file 113</a> |
| S1HumidBFR 5 Hz                     | Transforms Disabled for this tap | <input type="checkbox"/> DG.TEST,01 MIO                | <a href="#">RESP file 116</a> |
| S1ExtPresFR 5 Hz                    | Transforms Disabled for this tap | <input type="checkbox"/> DG.TEST,01 MDO                | <a href="#">RESP file 119</a> |
| S1APGFR 5 Hz                        | Transforms Disabled for this tap | <input type="checkbox"/> DG.TEST,01 MDU                | <a href="#">RESP file 122</a> |
| S1STAZFR 1 Hz                       | Transforms Disabled for this tap | <input type="checkbox"/> DG.TEST,01 LZ0                | <a href="#">RESP file 125</a> |
| S1LTAZFR 1 Hz                       | Transforms Disabled for this tap | <input type="checkbox"/> DG.TEST,01 LZ1                | <a href="#">RESP file 128</a> |
| S1RatioZFR 1 Hz                     | Transforms Disabled for this tap | <input type="checkbox"/> DG.TEST,01 LZ2                | <a href="#">RESP file 131</a> |

This page allows to configure the recording channels for each of the connected sensors. The names and contents of each channel are described in Section 11 on page **Error! Bookmark not defined.**



**Note:** Only the taps with name ending in FR (Fix Recording) should be enabled.





**Note:** When changing a setting in the Aquarius web page, ensure that you wait until the page refreshes before changing another setting. This allows time for the previous change to take effect.

The drop-down box at the top-left of the page named "Display Streams" filters out visible channels among Enabled and Disabled. The option "Apply configuration for tap groups" automatically apply the same configuration to three streams that belong to the same tap, e.g. S1SeisZFR, S1SeisNFR, S1SeisEFR. The drop-down box at the top-

## Aquarius Ocean Bottom System

right of the page named "Display On Page" allows to move from different instruments, e.g. Sensor 1.

The page is divided in four columns:

- in most-left column, drop-down boxes are available for each channel to either enable the recording or to exclude the channel from recording (by selecting the "Disabled" option). All streaming can be stopped by clicking the  button. Same configuration can be applied to recorded channels by clicking the  button. Default channel configuration can be applied by clicking the  button.



**Note:** The sample rates for FR channels are fixed:

- main seismic channel: 250 sps
- mass position, PLL offset, pressure, humidity, internal temperature and input voltage: 5 sps
- STA/LTA channels, power and external temperature: 1 sps.

- second column from the left is not relevant for the Aquarius OBS;
- in third column from left, Location and Channel SEED codes can be configured. Cells are greyed out by default (default values applied) and they can be edited by clicking on the check-box;
- in most-right column contains links to the RESP files associated to each of the seismic channels (see Section 7.2.8 on page **Error! Bookmark not defined.**).

Upon changing enabling/disabling channels or changing Location and Channels codes, the Aquarius will need to be restarted for the changes to come into effect; this can be done by pressing the  button.

Once the Aquarius has successfully restarted, the full web browser display and controls will be available for use again.

MicroSD cards need to be specifically formatted to operate with the Aquarius. The cards shipped with the Aquarius are supplied pre-formatted.

Data are stored on the microSD cards in miniSEED format. Each channel is saved as a series of 128 MiB files. Instrument and station meta-data (e.g. instrument response, coordinates, compression type etc.) are stored in "Dataless SEED" format.



The MicroSD card and data recording status can be monitored in the upper panel of the "Storage" tab.

The left-hand column provides details of the primary microSD card and the right-hand column shows the status of the backup card.

| SD Cards status                               |           |   |           |
|---|-----------|---|-----------|
| External microSD card present                 | PRESENT   | Number of 128-MiB miniSEED files              | 452       |
| External microSD card usable                  | USABLE    | Internal microSD card usable                  | USABLE    |
| External microSD card init count              | 1         | Internal microSD card init count              | 1         |
| External microSD card is primary microSD card | PRIMARY   | Internal microSD card is primary microSD card | BACKUP    |
| Primary microSD card is recording samples     | RECORDING | Backup microSD card is recording samples      | RECORDING |

Sections of this panel indicate the status of the following:

- Whether a card is inserted;
- Whether an inserted card is usable (i.e. correctly formatted); and
- Whether the card is recording data.

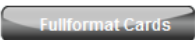
 **Note:** If the recording status of the cards is marked **NOT RECORDING**, clicking on  or  may solve the issue. Note that the quick format simply moves the write-pointer to the beginning of the recording space, hence overwriting any existing data. The full format, in contrast, erases all the existing data (and can take several hours).

The card re-formatting process fills the card with 128 MiB files containing zeroes. Each file is given a temporary, place-holder name. When data are written, these files are renamed and then over-written with data.

There are two methods for card reformatting: “Quick format” and “Full format”. The quick format mode should be used for pre-deployment tests (e.g. stomp/huddle tests) to ensure that the instruments are operating properly. This mode simply marks the existing files as empty without deleting their contents. Full formatting should be used prior to a long-term deployment to ensure that all headers are included and files are fully clean before writing.

The formatting process formats both fixed and removable cards, sequentially.

 **Note:** A series of tests separated only by quick formats can leave some files with residual data in them. This is not normally a problem because a deployment will typically create data-sets longer than any test, over-writing any data remaining from the tests.

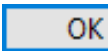
To quick-format the cards, click the  button in the “Storage” tab: a dialogue box will appear to confirm the formatting operation – click on  button to continue.

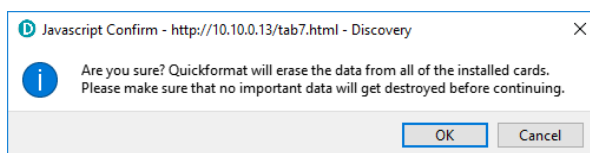

The instrument web page will refresh and return to the “Status” tab. The reformatting operation is now complete.

To full-format the cards, click the **Fullformat Cards** button in the “Storage” tab and a dialogue box will appear to confirm the formatting operation – click on **OK** button to continue.

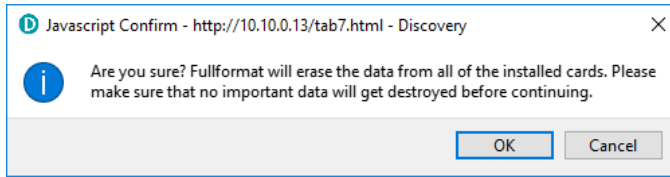

The process takes several hours: check the status countdown indicators on the top-right of “Storage” tab.



## 7.2.5 Download recorded data

The “Storage” tab of the web browser interface displays the miniSEED files stored on the microSD card:

System type: Aquarius | Host label: DIAS-AQUARIUS | Host name: AQU-00205A (10.30.0.73) | Serial number: 00205A

| SD Cards status                               |                  |
|---|------------------|
| External microSD card present                 | <b>PRESENT</b>   |
| External microSD card usable                  | <b>USABLE</b>    |
| External microSD card init count              | 1                |
| External microSD card is primary microSD card | <b>PRIMARY</b>   |
| Primary microSD card is recording samples     | <b>RECORDING</b> |

| SD Card files                         |              |                               |
|---------------------------------------|--------------|-------------------------------|
| Filename                              | Size (bytes) | Last data timestamp           |
| 00C95A_S1SeisEFR_00250_00000.mseed    | 18337792     | 2019-09-11 07:16:58.000000000 |
| 00C95A_S1SeisXFR_00100_00001.mseed    | 3272704      | 2019-09-11 07:16:58.000000000 |
| 00C95A_S1PresFR_00005_00002.mseed     | 483328       | 2019-09-11 07:16:58.000000000 |
| 00205A_S0TempRA_00010_00003.mseed     | 454656       | 2019-09-11 11:26:05.700000000 |
| 00205A_S0HumidA_00010_00004.mseed     | 450560       | 2019-09-11 11:26:30.200000000 |
| 00205A_S0Voltage_00010_00005.mseed    | 491520       | 2019-09-11 11:27:22.300000000 |
| 00C95A_S1TempRSeaFR_00001_00006.mseed | 204800       | 2019-09-11 07:16:58.000000000 |
| 00C95A_S1PowerFR_00001_00007.mseed    | 204800       | 2019-09-11 07:16:58.000000000 |
| 00C95A_S1RatioZFR_00001_00008.mseed   | 225280       | 2019-09-11 07:16:58.000000000 |
| 00C95A_S1LTAZFR_00001_00009.mseed     | 204800       | 2019-09-11 07:16:58.000000000 |
| 00C95A_S1STAZFR_00001_00010.mseed     | 204800       | 2019-09-11 07:16:58.000000000 |
| 00C95A_S1IntEFR_00005_00011.mseed     | 319488       | 2019-09-11 07:16:58.000000000 |
| 00C95A_S1IntNFR_00005_00012.mseed     | 299008       | 2019-09-11 07:16:58.000000000 |
| 00C95A_S1IntZFR_00005_00013.mseed     | 356352       | 2019-09-11 07:16:58.000000000 |
| 00C95A_S1ExtPresFR_00005_00014.mseed  | 331776       | 2019-09-11 07:16:58.000000000 |
| 00C95A_S1APGFR_00005_00015.mseed      | 339968       | 2019-09-11 07:16:58.000000000 |
| 00C95A_S1VoltageFR_00005_00016.mseed  | 356352       | 2019-09-11 07:16:58.000000000 |
| 00C95A_S1HumidBFR_00005_00017.mseed   | 368640       | 2019-09-11 07:16:58.000000000 |
| 00C95A_S1TempRBF_00005_00018.mseed    | 356352       | 2019-09-11 07:16:58.000000000 |
| 00205A_S0SeisXFR_00100_00019.mseed    | 3235840      | 2019-09-11 07:16:58.000000000 |

## Aquarius Ocean Bottom System

Clicking on the file from the list automatically starts a download using your browser's standard mechanism:

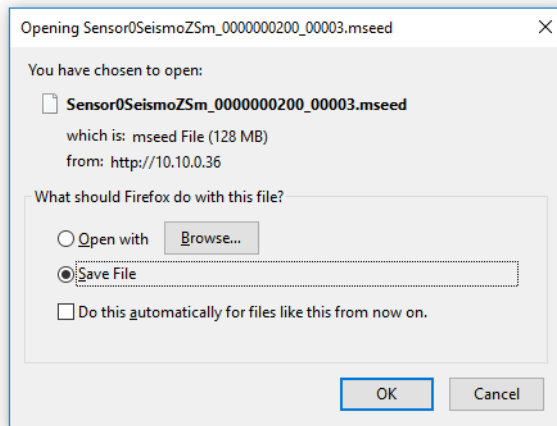

Multiple files can be downloaded simultaneously by ticking the boxes on the left of each link and clicking on **Download selected files** button.

Data for a single stream spanning a specific time-interval can be downloaded from the Storage page of the web interface. To do this, start by selecting the desired stream from the drop-down menu:

| Filename                                | Size (bytes) | Last data timestamp           |
|---|--------------|-------------------------------|
| Sensor0AccelZRou_0000000100_00000.mseed | 458752       | 2018-08-15 12:26:24.900000000 |
| Sensor0AccelERou_0000000100_00001.mseed | 487424       | 2018-08-15 12:25:02.750000000 |
| Sensor0AccelNRou_0000000100_00000.mseed | 528384       | 2018-08-15 12:28:54.980000000 |
| Sensor0SeismoESm_0000000200_00000.mseed | 2060288      | 2018-08-15 12:26:40.360000000 |
| Sensor0SeismoNSm_0000000200_00000.mseed | 2060288      | 2018-08-15 12:26:45.410000000 |
| status.log                              | 8624         | 2018-08-15 12:20:28.000000000 |
| system.log                              | 11425        | 2018-08-15 12:14:46.000000000 |
| init.log                                | 11425        | 2018-08-15 12:14:46.000000000 |
| table_of_events.bin                     | 1024         | 1969-12-31 23:59:42.000000000 |

**Auxiliary files**

| Filename     | Description                |
|--------------|----------------------------|
| DG.dataless  | less SEED file             |
| fram.log     | log file                   |
| calvals.txt  | AM! calibration values     |
| polezero.txt | AM! zeros, poles and gains |
| calib.txt    | calibration text file      |

Channel: DG.TEST.OK.HCA from: dd / mm / yyyy -- : -- To: dd / mm / yyyy -- : -- Download

... then select the start and end dates and times using the pop-up calendars:



## Aquarius Ocean Bottom System

The screenshot shows a web interface for the Aquarius Ocean Bottom System. At the top, there is a table with columns for file names, sizes, and timestamps. Below this is an 'Auxiliary files' section with a table listing files like 'DG\_dataless', 'fram.log', 'calvals.txt', 'polezero.txt', and 'calib.txt'. A calendar pop-up is displayed over the interface, showing the month of August 2018. The date '15' is highlighted. Below the calendar, there is a 'Channel data download by time selection' section with a 'Channel' dropdown set to 'DG.TEST.0K.HCA', a 'From' field set to 'dd/mm/yyyy', and a 'Download' button.

Lastly, click the [Download](#) download button to initiate a file transfer using your browser's standard mechanism.



**Note:** The pop-up calendars are not supported by Discovery's built-in browser and Explorer. The required dates can simply be typed in or the entire operation can be performed in an external web browser.

The "Storage" tab also shows links to five auxiliary files, which are either saved in the Aquarius flash RAM, in the microSD card or are dynamically generated:

The root directory of the SD card contains:

- a file named `init.log`. This contains the first 32MiB of system log information since the card was last formatted;
- a file named `system.log`. This contains the last 64MiB of the system log'
- a file named `status.log`. This contains the last 32MiB of dumps of system state of health information. A new dump is generated every 20 minutes.
- a file named `table_of_events.bin`. This is not human readable: it is used by the Seismic Events Table in the "Trigger" tab

|                          |                                     |       |                               |
|--------------------------|-------------------------------------|-------|-------------------------------|
| <input type="checkbox"/> | <a href="#">status.log</a>          | 42205 | 2019-09-11 11:13:19.000000000 |
| <input type="checkbox"/> | <a href="#">system.log</a>          | 45406 | 2019-09-11 11:32:05.000000000 |
| <input type="checkbox"/> | <a href="#">init.log</a>            | 45311 | 2019-09-11 11:32:05.000000000 |
| <input type="checkbox"/> | <a href="#">table_of_events.bin</a> | 39936 | 2019-09-11 06:54:55.000000000 |

The remaining files are listed in the Auxiliary files section:

- `network.DATALESS`: where *network* is the two-character Network code defined in the "Setup" tab (e.g. GU.DATALESS). This file is a Dataless SEED volume that contains meta-data including instrument responses, coordinates, compression type etc. The Dataless SEED volume is generated from the .RESP files for each channel;
- `fram.log`: FRAM log file (stored in FRAM);
- `calvals.txt`: calibration values in the format compatible with the Scream! Software package (dynamically generated);

## Aquarius Ocean Bottom System

- `polezero.txt`: poles, zeros and normalising factors in the format compatible with the Scream! software (dynamically generated);
- `calib.txt`: calibration text file with poles, zeros and gains expressed in hexadecimal (stored in FRAM);

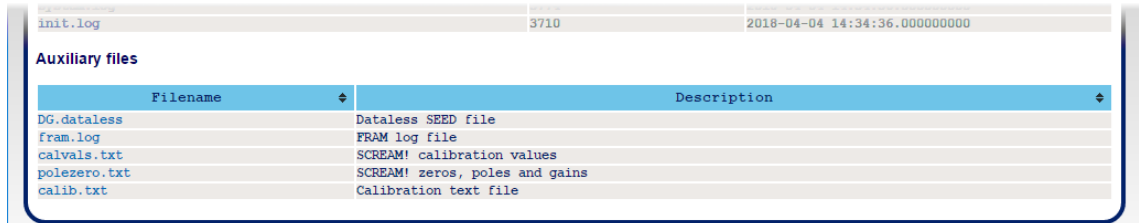

| Filename     | Description                    |
|--------------|--------------------------------|
| DG.dataless  | Dataless SEED file             |
| fram.log     | FRAM log file                  |
| calvals.txt  | SCREAM! calibration values     |
| polezero.txt | SCREAM! zeros, poles and gains |
| calib.txt    | Calibration text file          |

### 7.2.5.1 Bulk data extraction via network

Files stored on the SD card can be downloaded using HTTP. The example bash script below can be used from a Linux PC or from the WSL shell on a Windows PC: It extracts all files from the SD Card into a directory named after the date and the network address of the instrument.

```
#!/bin/bash
# Invoke with one argument: the network
# address of the instrument
set -x

if [ "$#" -ne 1 ] ; then
    echo "Usage: $(basename $0) network_address"
    exit 1
fi

NET_ADDRESS=$1
DATE=$(date --iso-8601)
SAVEDIR = ${DATE}_${NET_ADDRESS}
echo Saving to $$SAVEDIR

mkdir $$SAVEDIR
cd $$SAVEDIR
wget -rnp http://$NET_ADDRESS/tab9.html
cd ..

echo Done
```

### 7.2.5.2 Time based data extraction via network

The example Python script below will extract seismic data from the SD card based on a specified time interval. This is similar to the FDSN data archive retrieval service: <https://www.fdsn.org/webservices/fdsnws-dataselect-1.1.pdf>

Channel names are as given on the "Recording" tab of the web interface and the times are specified as UNIX Epoch seconds since 1970 (UTC). The resulting file is in MiniSeed format.

## Aquarius Ocean Bottom System

The script forms an http request to the instrument in the form  
<http://192.168.254.101/data?channel=DG.TEST.01.CHZ&from=1605810714&to=1605810814>

```
import os
import wget
from obspy import read, read_inventory, UTCDateTime
from obspy.signal import PPSD

##### Start of variable to set #####
temp = os.environ["TEMP"]
sensor = "192.168.254.101"
channel = "DG.TEST.01.HHZ"
start = UTCDateTime("2020-10-19T00:00:00.0")
end = UTCDateTime("2020-10-19T06:00:00.0")
##### End of variables to set #####

startUNIX = UTCDateTime(start).timestamp
#We use the 'start'&'end' to cut the data using Obspy
endUNIX = UTCDateTime(end).timestamp
# We use the 'startUNIX'&'endUNIX' to pull the
# data from the instrument

if os.path.exists(r"{0}\tt.mseed".format(temp)):
# See if temp file exists, if so delete.
    os.remove(r"{0}\tt.mseed".format(temp))

print(r"http://{0}/data?channel={1}&from={2}&to={3}".format(sensor, channel, startUNIX, endUNIX))
wget.download(r"http://{0}/data?channel={1}&from={2}&to={3}".format(sensor, channel, startUNIX, endUNIX),
r"{0}\tt.mseed".format(temp))

st = read(r'{0}\tt.mseed'.format(temp), starttime=start,
endtime=end, format='MSEED')
print(st)
st.plot()
dataless =
read_inventory(r'http://{0}/DG.dataless'.format(sensor))

ppsd = PPSD(st[0].stats, metadata=dataless)
ppsd.add(st)
ppsd.plot()
```

The following example in bash allows you to extract from the SD card the three seismic components at a given date and time, and specify the length of the miniSEED files. It then combines the three component in an individual miniSEED file, which name includes the network code, station code, start date and time :

```
#!/bin/bash
# Invoke with one argument: the IP address

set -x
```

## Aquarius Ocean Bottom System

```
# enter your network details
net_code=DG
station_code=04D67
location_code=0L

# choose the day
day=2024-04-28

# choose the start time in 24-hours format (e.g. 16 = 4pm)
start_hour=16

# choose the length of the miniSEED in hours (e.g. 1 = 1-hour-long
miniSEED)
step=1

utc=$(date --date ${day} +%s)
start_utc=$(expr $utc + 3600 \* ${start_hour})
end_utc=$(expr ${start_utc} + 3600 \* ${step})

echo $utc
echo $start_utc
echo $end_utc

wget -v -Oz_component.mseed
http://$1/data?channel=${net_code}.${station_code}.${location_code}
.HNZ\&from=${start_utc}\&to=${end_utc}
wget -v -On_component.mseed
http://$1/data?channel=${net_code}.${station_code}.${location_code}
.HNN\&from=${start_utc}\&to=${end_utc}
wget -v -Oe_component.mseed
http://$1/data?channel=${net_code}.${station_code}.${location_code}
.HNE\&from=${start_utc}\&to=${end_utc}

# Convert from Unix timestamp to date and time
date_string=`date -d @${start_utc} +%Y.%m.%d-%H.%M.%S`

# In this example, the 3-components miniSEED file will be named
"DG.04D67-2024.04.28-16.00.00.mseed"
cat z_component.mseed n_component.mseed e_component.mseed >
${net_code}.${station_code}-${date_string}.mseed
```

---

### 7.2.6 Acoustic modem set-up

The acoustic modems addresses can be configured from the “Network” tab in the Aquarius webpage.

## Aquarius Ocean Bottom System

| Acoustic Modem                                    |                 |   |                                   |
|---|-----------------|---|-----------------------------------|
| Local modem address                               | 5304            | Remote modem address  | 5308                              |
|   |                 | Power Levels & Gain   | Suitable in air                   |
|   |                 | Leave unchanged<br>TODO: Auto based on depth<br>Min power levels & Max gain<br><b>Suitable in air</b><br>Suitable down to 1000m<br>Suitable down to 3000m<br>Suitable down to 5000m<br>Suitable down to 6000m |                                   |
| WARNING: Non-default settings are in effect       |                 |   |                                   |
| Tunnel (ppp/l2tp settings) - Test                 |                 |   |                                   |
| LNS url   |                 | LNS Username  |                                   |
| No check has been performed yet                   |                 | Update Connection   | Start Test                        |
| Tunnel (ppp/l2tp settings) - Permanent Connection |                 |   |                                   |
| LNS url_ip  | gc01.guralp.com | Connection status   | Connection has not started yet... |
|   |                 |   | off                               |

- “Local modem address” is the address of the acoustic modem in the seabed unit.
- “Remote modem address” is the address of the acoustic modem at the surface.
- The drop-down menu “Power Levels & Gain” allows to automatically set the appropriate acoustic modem power levels selecting the relevant deployment scenario.

### 7.2.7 Deploying the Aquarius

Before deployment the Aquarius will need to be set in “Full Power Save” mode.

“Full Power Save” mode makes a number of configuration changes in order to reduce the unit's power consumption and it is meant to be used any time the Aquarius is going to be deployed on the seabed.

The “Full Power Save” mode can be specified using the “Deploy mode” drop-down menu in the “Setup” tab of the Aquarius web page. Changes are not applied immediately.

The screenshot shows the Aquarius web interface with the 'Setup' tab selected. The 'Deploy Mode' dropdown menu is open, showing 'Normal' selected and 'Power Save' as an option. The 'Deploy' button is highlighted with a red box. The interface also shows system information, digitizer controls, and configuration settings.

The final step is to click on the **Deploy** button and confirm or cancel the operation from the pop-up window that appears.

|                                       |                 |   |  |  |             |
|---------------------------------------|-----------------|---|--|--|-------------|
| <b>Digitizer Controls</b>             |                 |   |  | The "Reset All Settings" button will ALSO affect settings on other pages |             |
| <input type="button" value="Reboot"/> |                 | <input type="button" value="Reset All Settings"/> |  |  |             |
| <b>Digitizer Config</b>               |                 | System is about to be deployed. Are you sure?     |  |  |             |
| Date                                  | Wed 11 Sep 2019 | Time  |  | 1  | Auto Reboot |
| Host Label                            | DIAS-AQUARIUS   | Station Code                                      |  | DG   | Site Name   |
| Bluetooth PIN                         | 0000            | Bluetooth   |  | High   |             |
| Deploy Mode                           | Power Save      | Auto Center D                                     |  |  | Time Offset |
| Undeploy                              |                 | Flush to SD                                       |  | <input type="button" value="Perform deployment."/>                       |             |

A thirty-second count-down will start before the system enters power-save mode. The screen changes and a new button is added:

|                                 |                 |                         |            |                |   |
|---------------------------------|-----------------|-------------------------|------------|----------------|---|
| <b>Digitizer Config</b>         |                 |                         |            |                |   |
| Date                            | Wed 11 Sep 2019 | Time                    | 1:02:04 PM | Auto Refresh   | 1   |
| Host Label                      | DIAS-AQUARIUS   | Station Code            | TEST       | Network Code   | DG  |
| Bluetooth PIN                   | 0000            | Bluetooth               | Enabled    | Filter quality | High  |
| Deploy Mode                     | Power Save      | Auto Center Disable(hr) | 1          | Deploy         | <input type="button" value="Abort deployment"/> |
| You can abort deployment within | 26s             | Time Offset             | -3ms       | Undeploy       | Flush to SD                                     |

You can cancel the operation before the countdown is complete by clicking the  button.

When the Aquarius is set in "Full Power Save" mode and it has been deployed the LPC's LAN interface is switched off and the ULPD starts recording the FR channels.

At the recovery, the LPC can be rebooted with its LAN on turning on the PoE.

Recording in the ULPD can be stopped pressing the  button. As stated in Section 4.3 on page **Error! Bookmark not defined.** even pressing the  button the ULPD will stay in its deployed state until next reboot (see Section 6.3 on page **Error! Bookmark not defined.**) or power cycle (see Section 4.12 on page **Error! Bookmark not defined.**).

## 7.2.8 Calibration data

Calibration is a procedure used to verify or measure the frequency response and sensitivity of a sensor. It establishes the relationship between actual ground motion and the corresponding output voltage. Calibration values, or response parameters, are the results of such procedures.

Response parameters typically consist of a sensitivity or "gain", measured at some specified frequency, and a set of poles and zeroes for the transfer function that expresses the frequency response of the sensor. A full discussion of poles and zeroes is beyond the scope of this manual.

The gain for a seismometer is traditionally expressed in volts per ms<sup>-1</sup> and, for an accelerometer, in volts per ms<sup>-2</sup>. Other instruments may use different units: an electronic thermometer might characterize its output in mV per °C.

A calibration procedure is also used to establish the relationship between the input voltage that a digitiser sees and the output, in counts, that it produces. The results are

## Aquarius Ocean Bottom System

traditionally expressed in volts per count. Each Aquarius is programmed at the factory so that it knows its own calibration values.

When transmitting miniSEED data, the responses of the instruments and digitisers are encoded in a message called a "Dataless SEED" volume. The contents of these volumes can be displayed in human-readable form, known as RESP, by clicking on the "RESP file" link of each channel in the "Data Stream" and "Data Record" tab in the web page.

Clicking on a RESP file link produces a page like this:

```
#          << Guralp SEED response file builder v1.2-8615 >>
#
#          ===== CHANNEL RESPONSE DATA =====
B050F03  Station:      TEST
B050F16  Network:       DG
B052F03  Location:      OK
B052F04  Channel:       HNZ
B052F22  Start date:   2018,214,11:26:48
B052F23  End date:     No Ending Time
#
#          +-----+
#          | Channel Sensitivity, TEST ch HNZ |
#          +-----+
#
B058F03  Stage sequence number:      0
B058F04  Sensitivity:                2.131148E+05
B058F05  Frequency of sensitivity:  1.000000E+00 HZ
B058F06  Number of calibrations:     0
#
#          +-----+
#          | Response (Poles & Zeros), TEST ch HNZ |
#          +-----+
#
B053F03  Transfer function type:     A [Laplace Transform (Rad/sec)]
B053F04  Stage sequence number:     1
B053F05  Response in units lookup:  M/S**2 - Acceleration in Metres Per Second Squared
B053F06  Response out units lookup:  V - Volts
B053F07  A0 normalization factor:   3.022955E+12
B053F08  Normalization frequency:   1.000000E+00
```

Right-click anywhere and select "Back" to return to the Aquarius web-page.

# Aquarius Ocean Bottom System

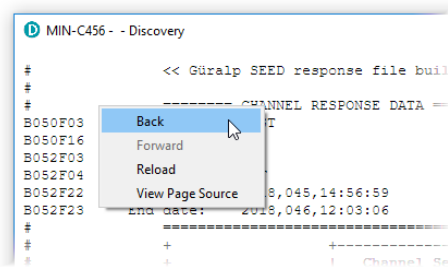

To save a RESP file, right click on it in the main list and select "Save Link":

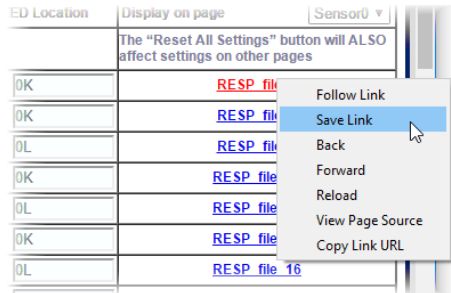



## 8 Pre-deployment procedures

### 8.1 Charging batteries

Follow the instruction in Section 5.4 on page 23 to charge the batteries correctly before the deployment.

### 8.2 Attach Ballast and Burn-Wire System

#### 8.2.1 Locate System on Ballast

The Aquarius system (comprising of pressure vessel, buoyancy and ancillaries) sits in/on-top-of twin steel ballast rings. The Aquarius system is lowered (by the lifting frame) down on to new ballast rings.



The easiest way to approach this task is to raise the plates off the ground with suitable blocks first, to ensure the lowered Aquarius system sits down on to the ballast plates directly rather than resting on the ground. This can make aligning the circular ridge on the Aquarius buoyancy with the inner circle of the ballast easier, and reduces the force required by the burn-wire tensioning tool (which would otherwise be required to lift the ballast plates before tensioning occurred).

The ballast plates each have three pairs of opposing slots cut into their perimeters at equal intervals, each with a different slot depth. These allow for three different pre-

## Aquarius Ocean Bottom System

tension settings for the straps suspending the ballast plates, to account for manufacturing variances in the straps and buoyancy.



It is essential to ensure that the slots are correctly aligned between the two ballast plates before proceeding.

Select an opposing pair of slots in the ballast plates (if in doubt, pick the middle pair) and insert the two strap loops into these slots.



Ensure that the strap loops are located as far into the slots as possible, so they cannot slip out when tension is applied.

## Aquarius Ocean Bottom System



Now carefully lower the Aquarius system onto the ballast plates.

As the system is being lowered, observe that the protruding circular rim in the underside of the buoyancy aligns and locates properly into the inner circle of the ballast plates. Therefore, the buoyancy is permitted to sit down fully into the ballast plates.

In addition, ensure that the Aquarius system is rotationally aligned with the chosen slots in the ballast plates, such that the straps will travel vertically from the ballast plate slots to the hooks in the burn-wire arms.



### 8.2.2 Tension Burn-Wire

With the Aquarius system located on ballast plates, ensure that the two strap loops are hooked securely over the burn-wire arms. When brought together, the arms should rest equidistantly from the lifting frame (and the centre of the Aquarius) as shown below.

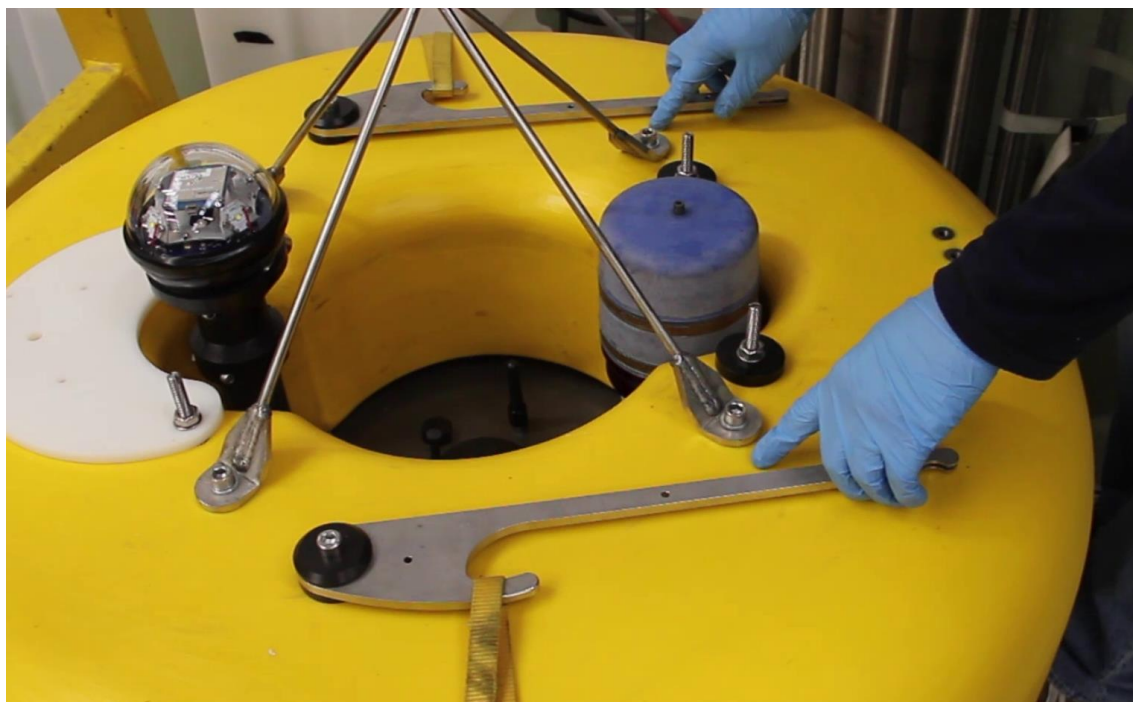

## Aquarius Ocean Bottom System

If the arms are not equidistantly spaced, this indicates that either;

- the buoyancy is not properly located into the ballast plates
- the Aquarius is not rotationally aligned with the chosen strap slots on the ballast rings.

In either case, the Aquarius and ballast arrangement must be adjusted.

## Aquarius Ocean Bottom System

The arms must be tensioned to permit the burn-wire to be installed. Use the supplied burn-wire tensioning tool to achieve this.

Locate the white wire loop around the smaller/inner notch in one of the arms as shown below:

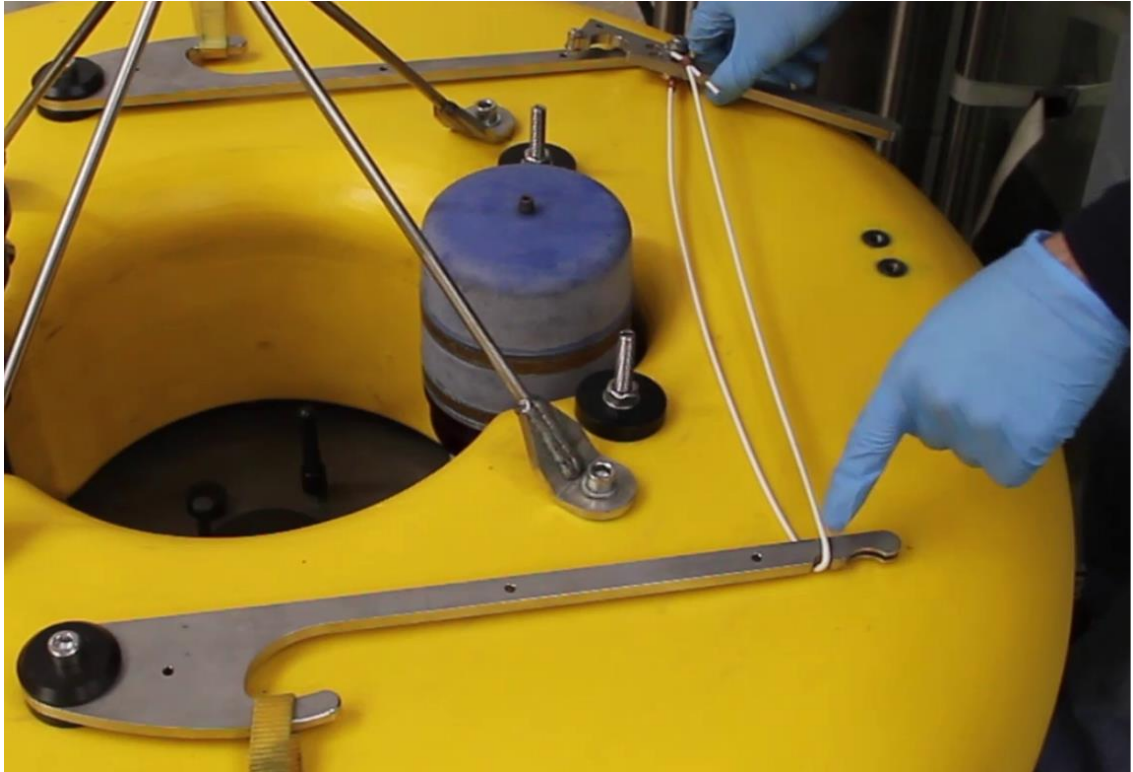

Then align the tip of tensioning tool into the smaller/inner notch in the opposing arm as shown below. Ensure that the retaining washers straddle the arm to prevent the tensioning tool slipping.



## Aquarius Ocean Bottom System

Now pivot the tensioning tool around the inner/smaller notch to bring the two arms together. Take care to ensure that the wire loop passes around the arm and pivot point.



With the arms tensioned with the tensioning tool, insert each end of a new burn-wire into the larger/outer notch of each of the arms.

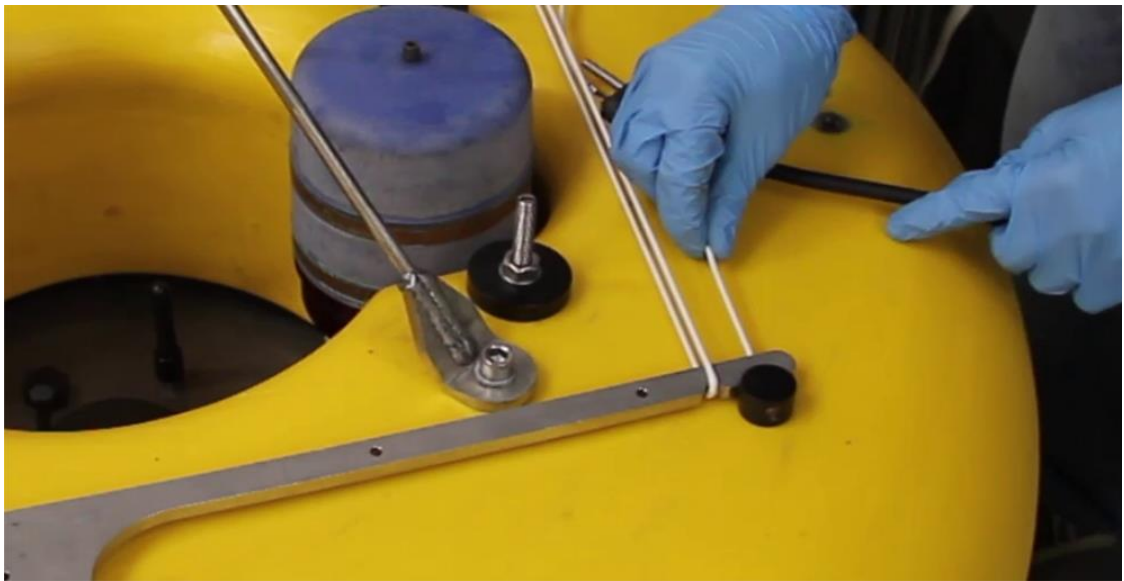

Ensure that the burn-wire itself passes through the slots cut into the arms.

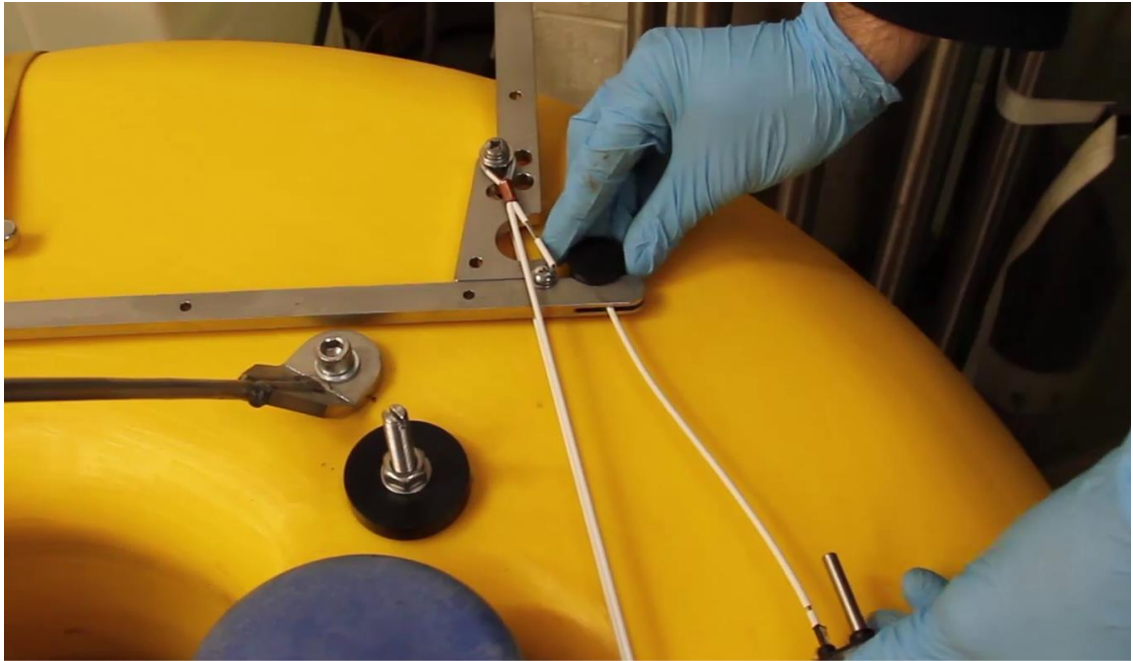

With the burn-wire in place, now release the tensioning tool to transfer the tension of the ballast release system from the tool to the burn-wire itself.

As tension is transferred, ensure that the tensioning tool wire loop passes cleanly around the burn-wire ends and does not force them from the arm notches.

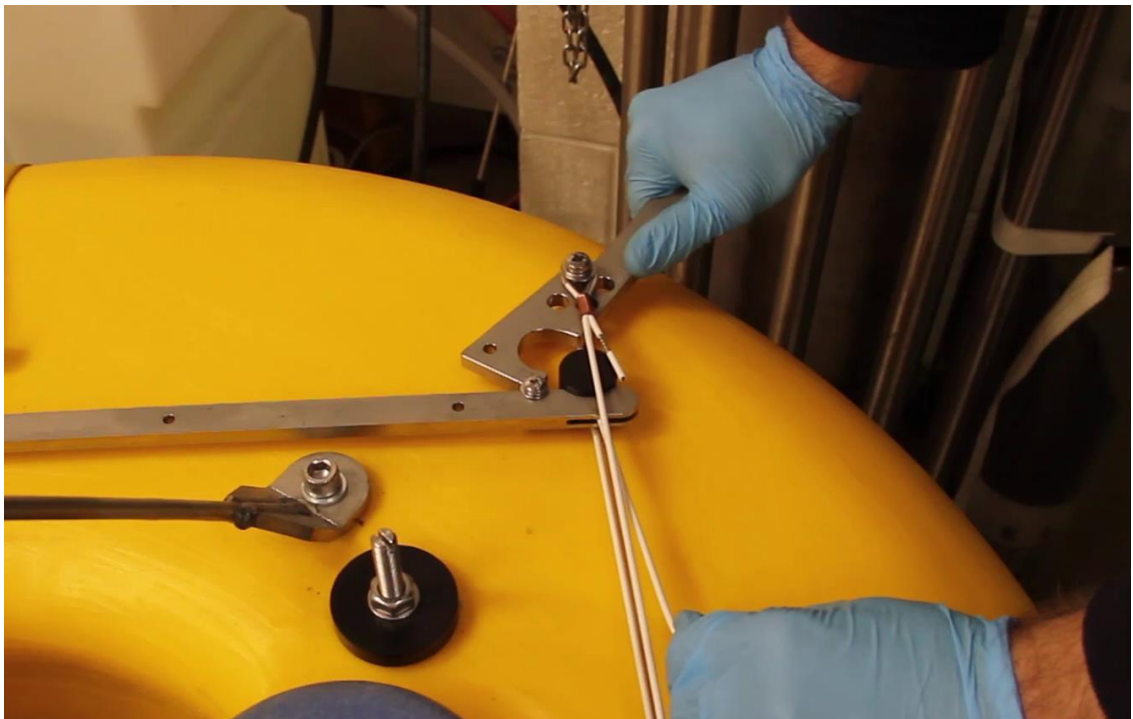

As the tensioning tool is removed, the burn-wire passes completely through the tensioning tool wire loop, including the central potted junction node and electrical cable.



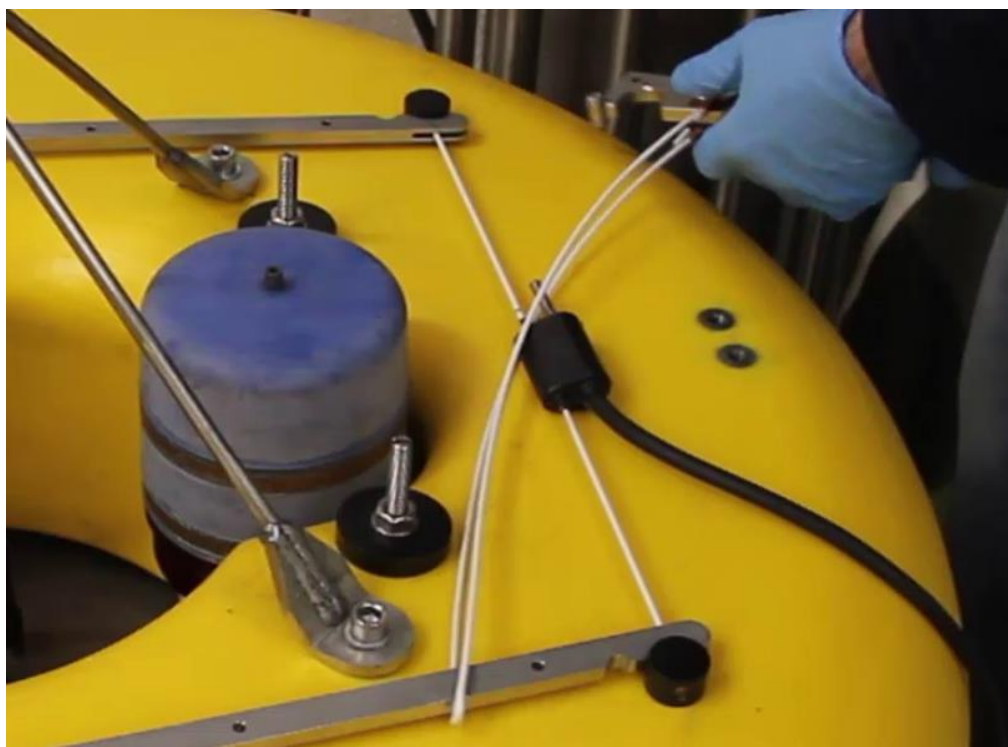

Finally, after cleaning and applying grease as required the two way Subconn burn-wire connector may be mated with the cable loom. The electrical operation of the burn-wire should be verified by manually activating the burn-wire from Discovery and assessing the anode to cathode voltage with a multimeter.

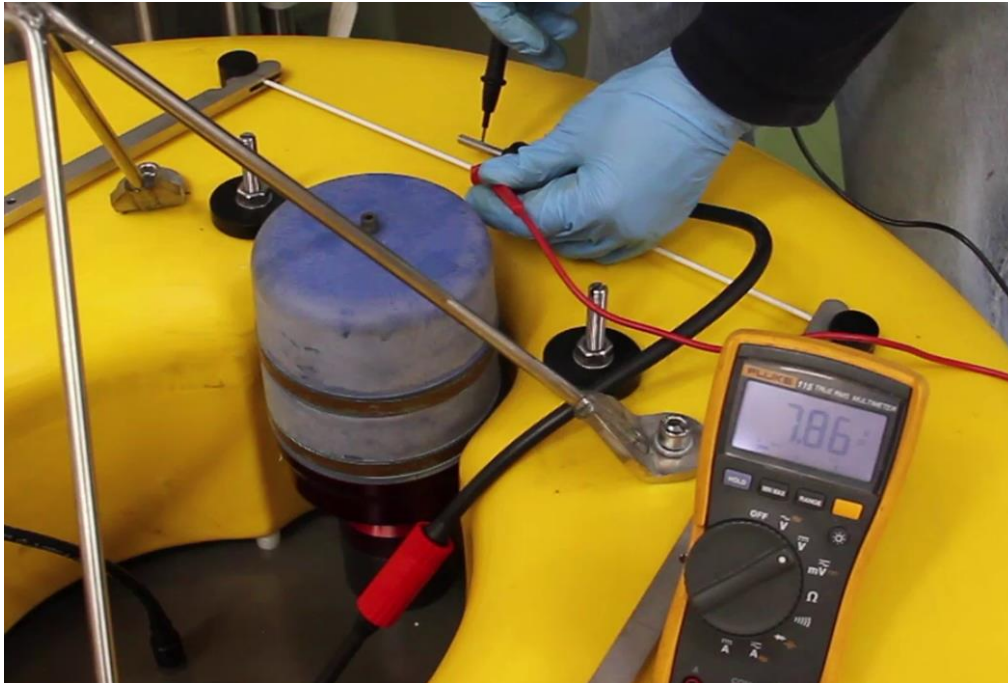

---

## 8.3 Time synchronization and configuration

Follow the instruction in Section 7.2.2 on page **Error! Bookmark not defined.** to configure the PTP settings. If using the deck unit, PTP must be set in unicast mode, with I.P. 192.168.0.10.

Use the “OBS Command & Control” widget (see Section 7.1.3.2 on page 35) to obtain the time offset when the PTP reaches a good stability. Offset should be 0ms before deployment.

Follow the procedure in Section 13 on page 100 when configuring the Aquarius using the web page (see Section 7.2 on page 47) and the “OBS Command & Control” widget (see Section 7.1.3, page 33). This procedure also check all sensors in the Aquarius and the Burn-Wire, so the APG and the Burn-Wires need to be connected using the relevant cable.

---

## 8.4 Acoustic communication check

It is important to verify the operation of the acoustic modems before deployment. Although not optimal, it is possible to operate the modems out of water with the use of a suitable acoustic coupler. One such aluminium coupler is supplied with your system.

By placing the coupler on the Aquarius modem transducer, the topside Dunker modem may then be stacked on top and temporarily held or secured in place.

Set both modems to power levels suitable for operation in air, refer to Section 7.1.3.3 on page 38.



**Caution:** Remember to set the acoustic settings of both modems appropriately for the intended operational depth before deployment.

Follow the instruction in Section 7.1.3.4 on page 40 to verify whether the acoustic link is properly working. Note that only low data transfer speeds will be possible and the failure rate of acoustic transactions may be high. This is normal when out of water.

## 8.5 Final assembling

When time synchronization, configuration and test of the Aquarius has been completed, the Ethernet and serial cable can be disconnected from the OBS top lid. Place the Seacon Hummer series dummy cap and screw the locking sleeve down. Check also connection of the accessory and Burn-Wire cable by the 8 way Subconn Mini series connector.

Check that all the other caps have been properly screwed down with all the O-rings in place.

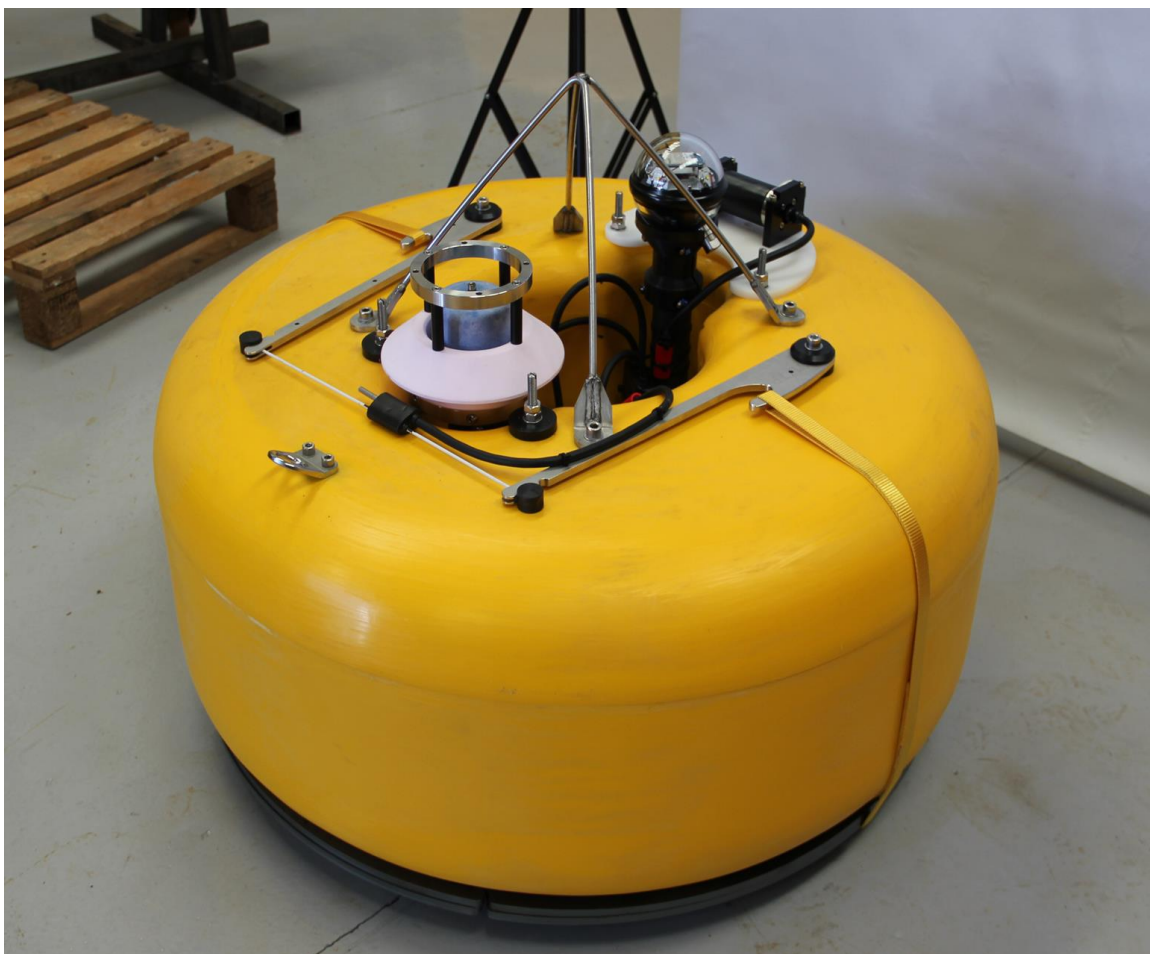

## 9 Post Deployment procedure

### 9.1 Checking seismometer's data

If working with the deck unit and a local surface dunker, open Discovery and start the "OBS Command & Control" widget from the menu "View" → "OBS" → "Command & Control".

Verify in the "OBS Command & Control" widget the correctness of the I.P. address ("localhost" if working in local) and use the "Connect" button on top of the window to establish the connection.

Follow the instructions in Section 7.1.3.4 on page 44 to download the desired set of data.

### 9.2 OBS Locator

This widget can be used to determine the location of the Aquarius once it reaches the seabed or to monitor its drift during its free fall, monitor the trajectory of the boat as it travels, load and visualize previous data.

Open Discovery and the "OBS Command & Control" widget. Verify the correctness of the I.P. address and use the "Connect" button on top of the window to establish the connection. Keeping the "OBS Command & Control" window open, click on menu "View" → "OBS" → "Locator" to open the "OBS Locator" widget.

## Aquarius Ocean Bottom System

| System    | Name           | Serial#      | WAN Address | LAN Address | Uptime         |
|-----------|----------------|--------------|-------------|-------------|----------------|
| Affinity  | DAS-40554C     | 40554C       | 0.0.0.0     | 10.30.0.10  | 636 days 1 Hrs |
| Affinity  | DAS-405552     | 405552       | 0.0.0.0     | 10.30.0.59  | 342 days 6 Hrs |
| AQU       | 001E5A         | 7770         | 0.0.0.0     | 10.30.0.85  | 00:20:01       |
| AQU       | 315B           | 12635        | 0.0.0.0     | 10.30.0.32  | 05:23:13       |
| AQU       | 3B5C           | 15196        | 0.0.0.0     | 10.30.0.136 | 01:15:32       |
| AQU       | 755C           | 30044        | 0.0.0.0     | 10.30.0.88  | 4 days 3 Hrs   |
| Aquarius  | AQU-555C       | 21852        | 0.0.0.0     | 10.30.0.103 | 01:13:56       |
| Certimus  | CERT-CC5A      | 52314        | 0.0.0.0     | 10.30.0.102 | 3 days 4 Hrs   |
| Certimus  | CERT-F85C      | 63580        | 0.0.0.0     | 10.30.0.62  | 2 days 23 Hrs  |
| Discovery | Ojczysta       | 3417EBDFD616 | 0.0.0.0     | 10.30.0.33  | 10 days 4 Hrs  |
| Discovery | aquarius-demo1 | 4C5262264CEC | 0.0.0.0     | 10.30.0.41  | 00:21:12       |
| EAM       | eam3467        | 3467         | 0.0.0.0     | 10.30.0.47  | 468 days 6 Hrs |
| EAM       | eam2887        | 2887         | 0.0.0.0     | 10.30.0.42  | 27 days 6 Hrs  |
| Fortimus  | FMUS-165A      | 5722         | 0.0.0.0     | 10.30.0.121 | 00:50:07       |
| Fortimus  | FMUS-8B59      | 35673        | 0.0.0.0     | 10.30.0.65  | 4 days 0 Hrs   |
| Fortimus  | FMUS-004E5A    | 20058        | 0.0.0.0     | 10.30.0.107 | 5 days 22 Hrs  |
| Fortimus  | FMUS-9059      | 36953        | 0.0.0.0     | 10.30.0.58  | 01:13:31       |

### 9.2.1 Overview

The “OBS Locator” widget can:

- Ping (manually or automatically) the acoustic modem and automatically calculate the slant range from the ping return time.
- Request the depth of the Aquarius, resolved by the Keller pressure sensor.
- Automatically plot surface circles indicating the area of location of the Aquarius.
- Track boat movements by plotting its relative position every 5 seconds.
- Manually adjust the depth of the Aquarius, if correction is needed.
- Set the value for the speed of sound in water.
- Save data log files.
- Load and visualise previous log files.

### 9.2.2 Locating Aquarius

Before you continue, make sure a successful connection has been established (see Section 7.1.3 on page **Error! Bookmark not defined.**), i.e. the modem state in the status bar says “Ready”.

## Aquarius Ocean Bottom System

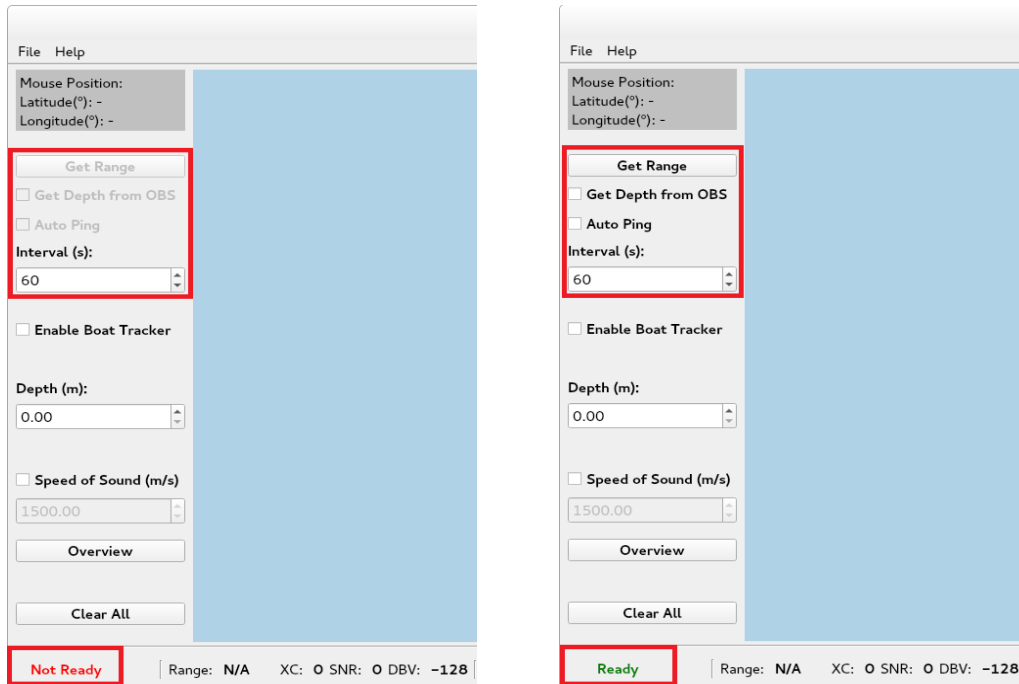

### 9.2.2.1 Pinging the bottom unit

Pinging the acoustic modem could be done either manually or automatically. For manual control, click on “Get Range” button. Alternatively, a timer can be set, on which timeout a ping will be sent. The slant range between the boat and the unit is calculated from the Turn-Around-Time.

If “Get Depth from OBS” box is checked when a ping is sent, the pressure value from the Keller pressure sensor is also requested. The value of the depth will automatically get updated in the “Depth (m)” spin-box.



**Note:** Requesting and transmitting data from the Keller pressure sensor uses more power than pinging the acoustic modem. Uncheck the box once the unit reaches the sea bed.

Once the slant range and depth are calculated, a circle with a radius equal to the surface distance between the boat (*black* cross) and the Aquarius is plotted.

## Aquarius Ocean Bottom System

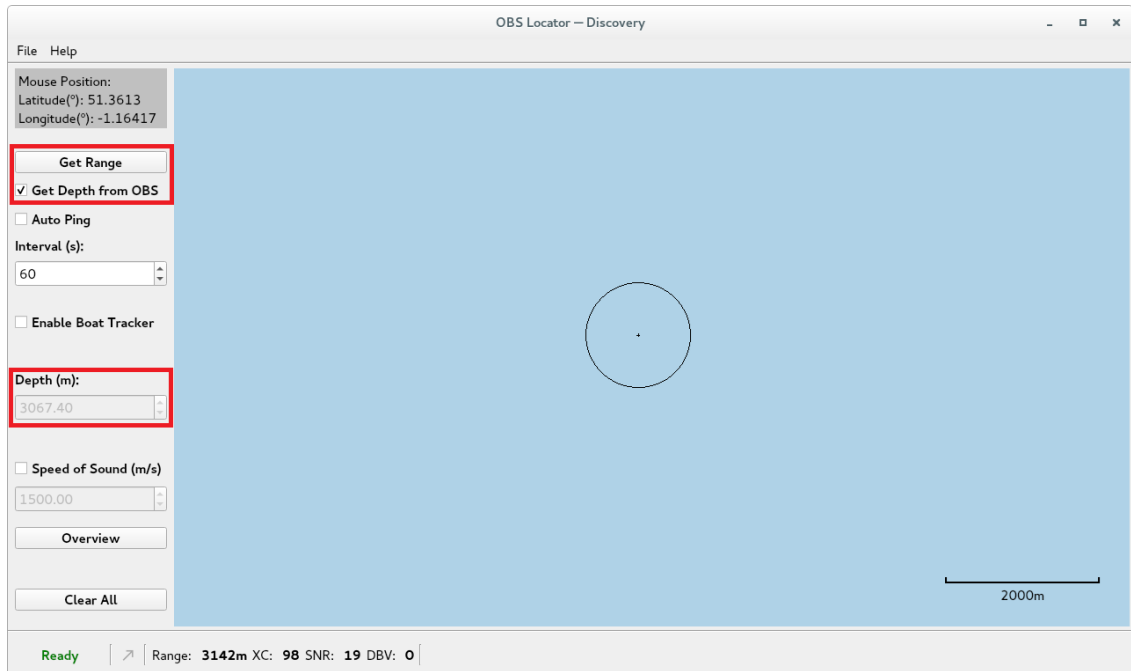

### 9.2.2.2 Recording Aquarius location

Use the “Depth (m)” to manually adjust the depth of the unit, if the circles fail to intersect in a single point. All circles will be dynamically replotted with a radius corresponding to the new depth.

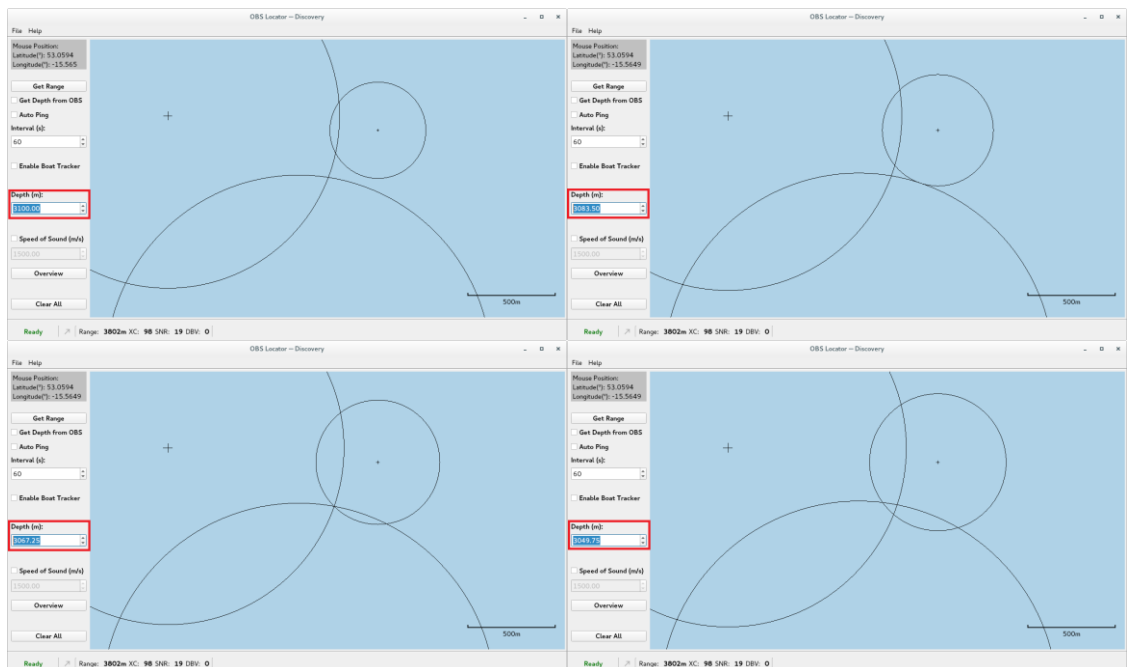

Mark the Aquarius location (*blue* cross) by zooming IN and double-clicking on the intersection point of the circles.

## Aquarius Ocean Bottom System

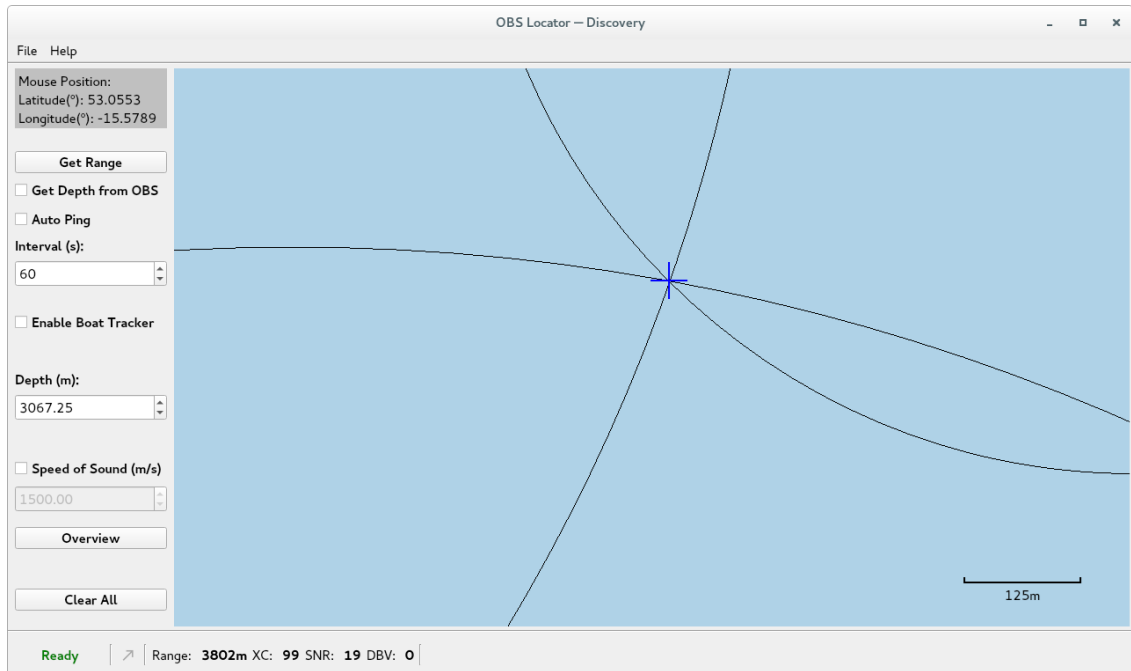

### 9.2.2.3 Boat Tracker

The boat tracking feature is activated when “Enable Boat Tracker” is checked. It plots the relative location of the boat (*red* triangle) and its trajectory every 5 seconds. It is intended to provide an overview of the boat movement when travelling during the triangulation process.



**Note:** None of these locations are recorded in the log file.



**Caution:** This tool is not intended for navigation use.



## Aquarius Ocean Bottom System



### 9.2.2.4 Speed of Sound

The default value for the speed of sound used to calculate the slant range from the ping return time is 1,500m/s.

To change it, check the "Speed of Sound (m/s)" box and enter a different value. The change will also effect the already plotted circles.

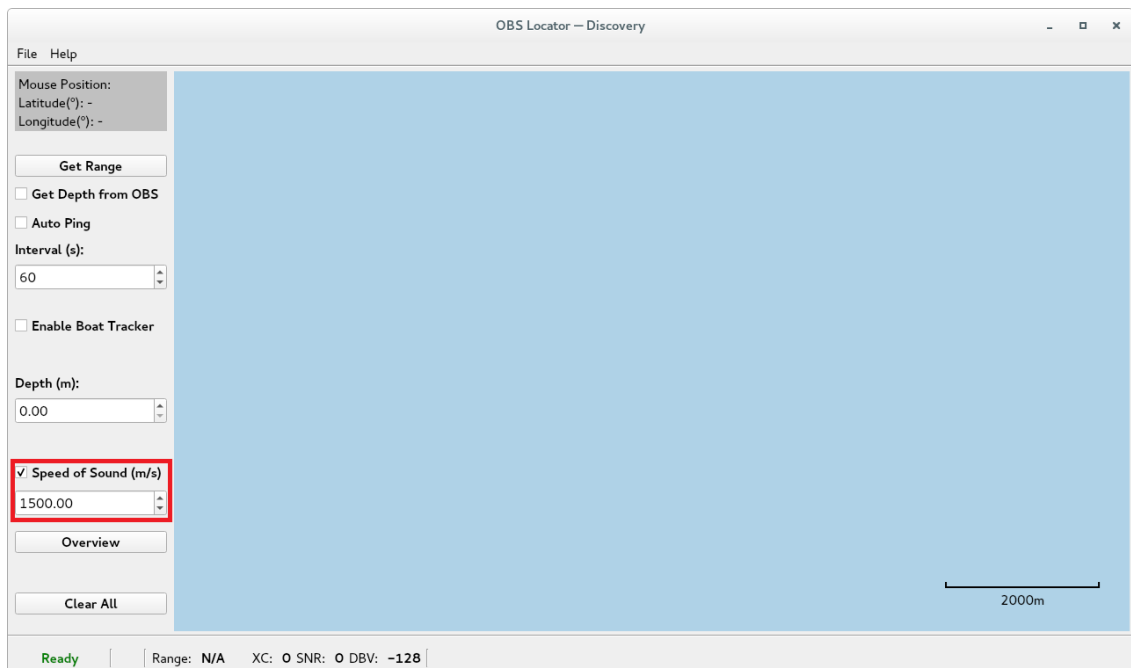

### 9.2.2.5 Map Navigation

“Mouse Position” indicates the location on the map under the centre of the cursor. It is disabled by default until an event is recorded and plotted.

Use the “Overview” button to zoom the current view of the map to fit all graphical items.

Use the “Clear All” button to clear all graphical items from the map.

The bar in the bottom right corner of the map indicates the current map scale.



### 9.2.3 Data processing



**Note:** None of the modifications described below are automatically saved. Once finished, save the changes to a log file via “Save As” button in the “File” menu or Ctrl+S.

#### 9.2.3.1 Add Circle

To add a new circle manually, right-click and select “Add Circle”. In the “Add/Edit” box, enter the desired location (latitude and longitude), range, OBS depth and speed of sound and click on “Add”.

# Aquarius Ocean Bottom System

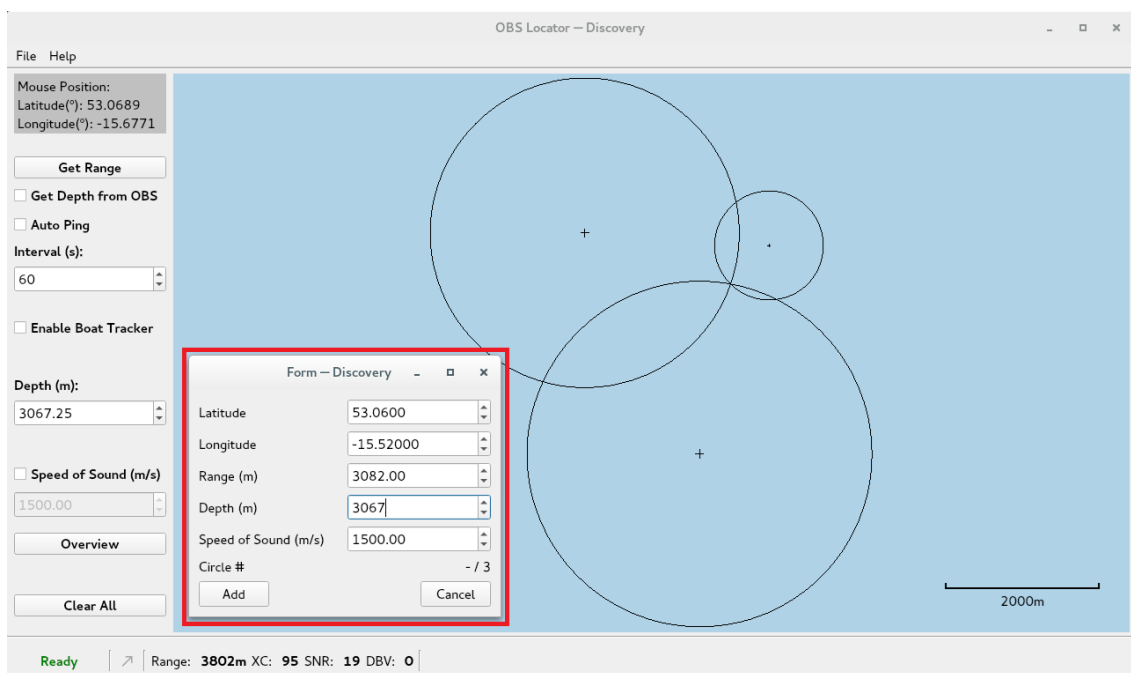
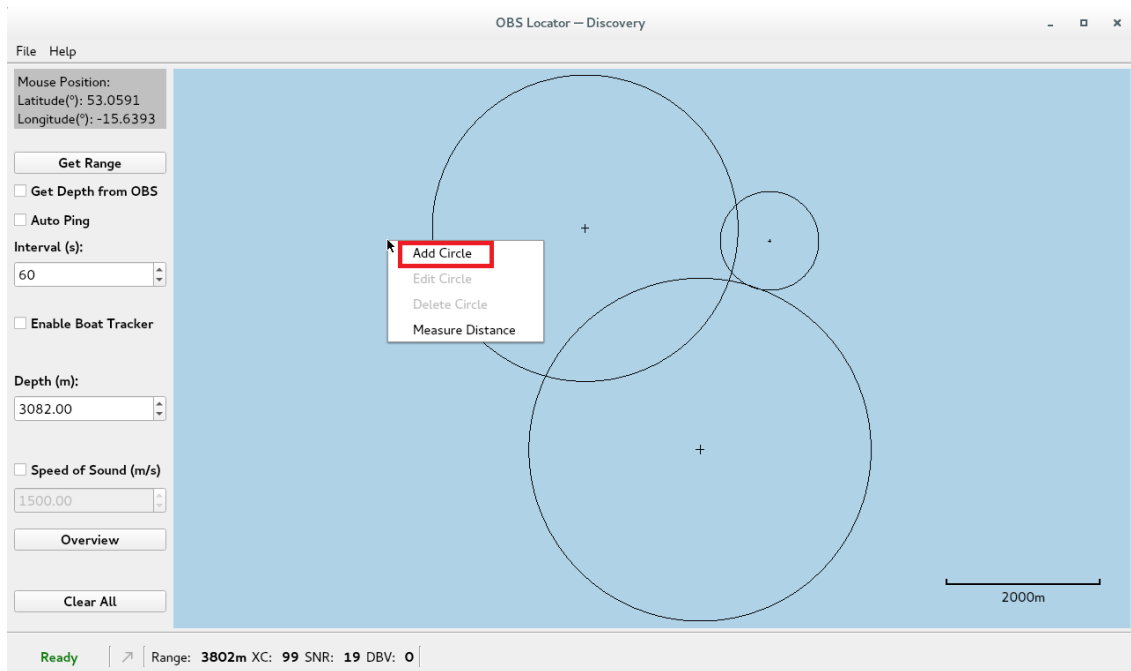

## Aquarius Ocean Bottom System

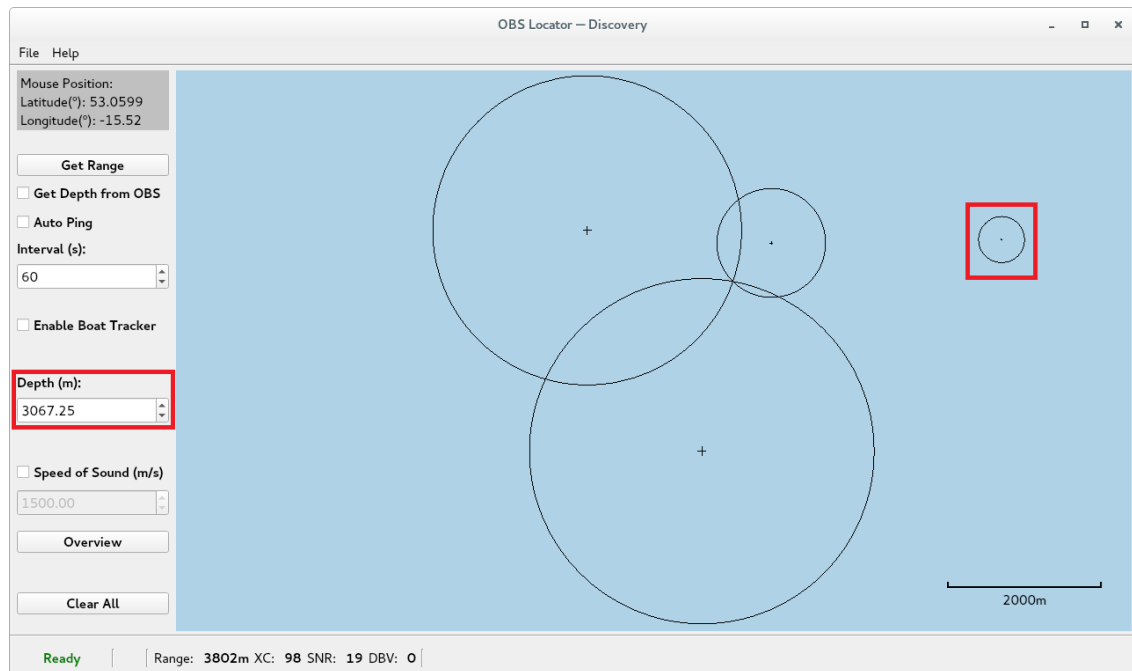

**Note:** Manually added circles will be automatically painted using the value of the current depth rather than their own depth. In cases when the value of the current depth is greater than the value of the slant range, this circle will not be visible until the current depth is less than the range.

### 9.2.3.2 *Edit Circle*

To edit an existing circle, right-click on it and select “Edit Circle”. The circle to be edited will get highlighted and an “Add/Edit” box will open with the current parameters of this circle. To change any of them, simply use the spin-box arrows or the keyboard. Changes apply immediately.

# Aquarius Ocean Bottom System

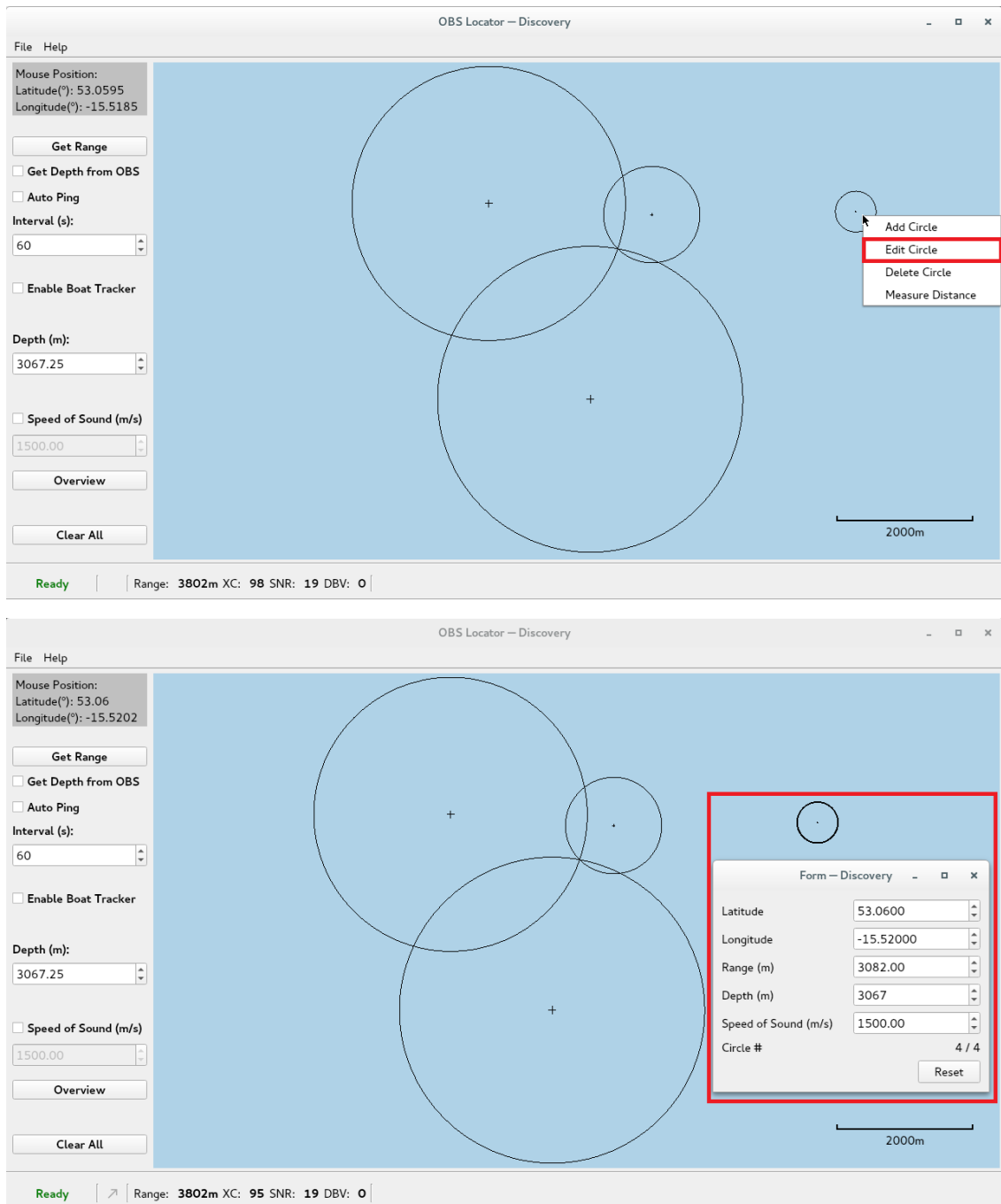

### 9.2.3.3 Delete Circle

To delete an existing circle, right-click on it and select “Delete Circle”.

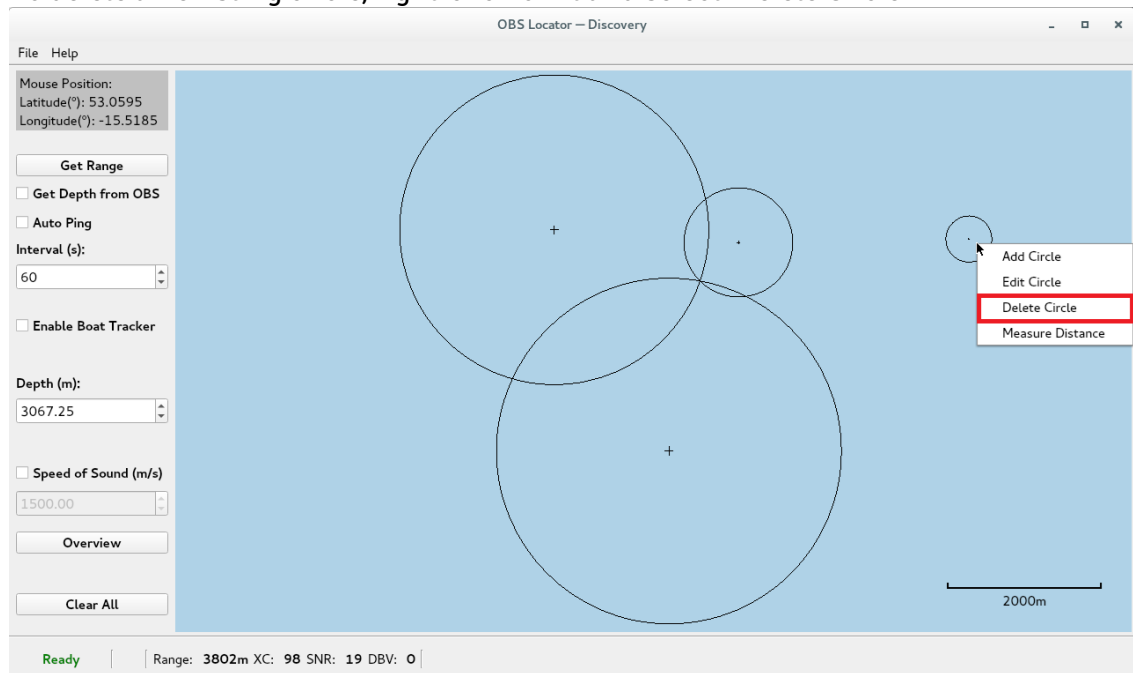

### 9.2.3.4 Measure Distance

“Measure Distance” tool is useful for measuring the distance between two or multiple points on the map. To use it, right-click on the map and select “Measure Distance”.

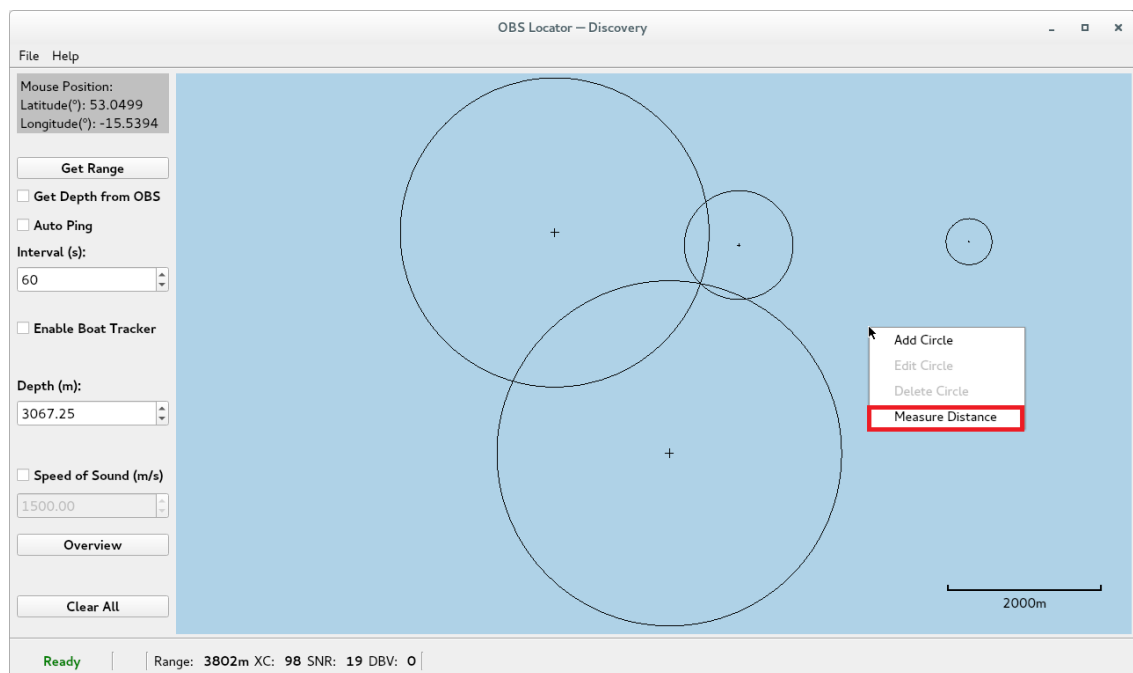

To add a new point, double-click on the map and a white dot will mark it. The distance next to each dot indicates the total distance between that point and the first one.

## Aquarius Ocean Bottom System

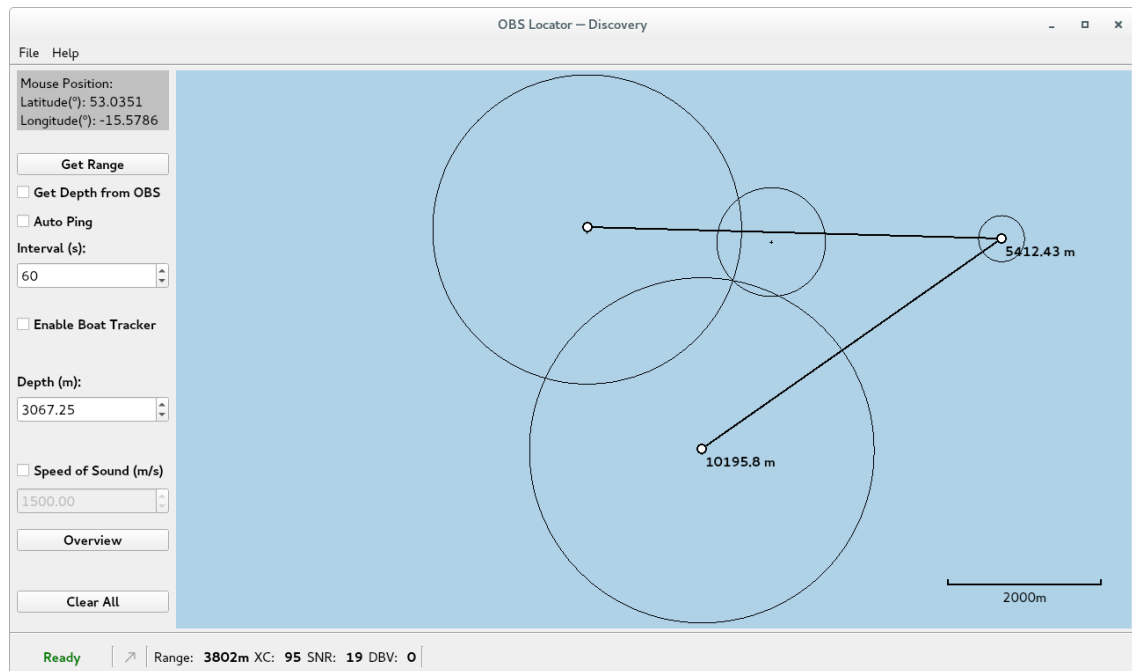

To delete an existing point, click on it. If it is a middle point, the distance between its neighbours is measured instead and the total distance for each point gets updated. If it is the last point, the last distance segment is removed. The first point cannot be deleted unless all other points are deleted first.

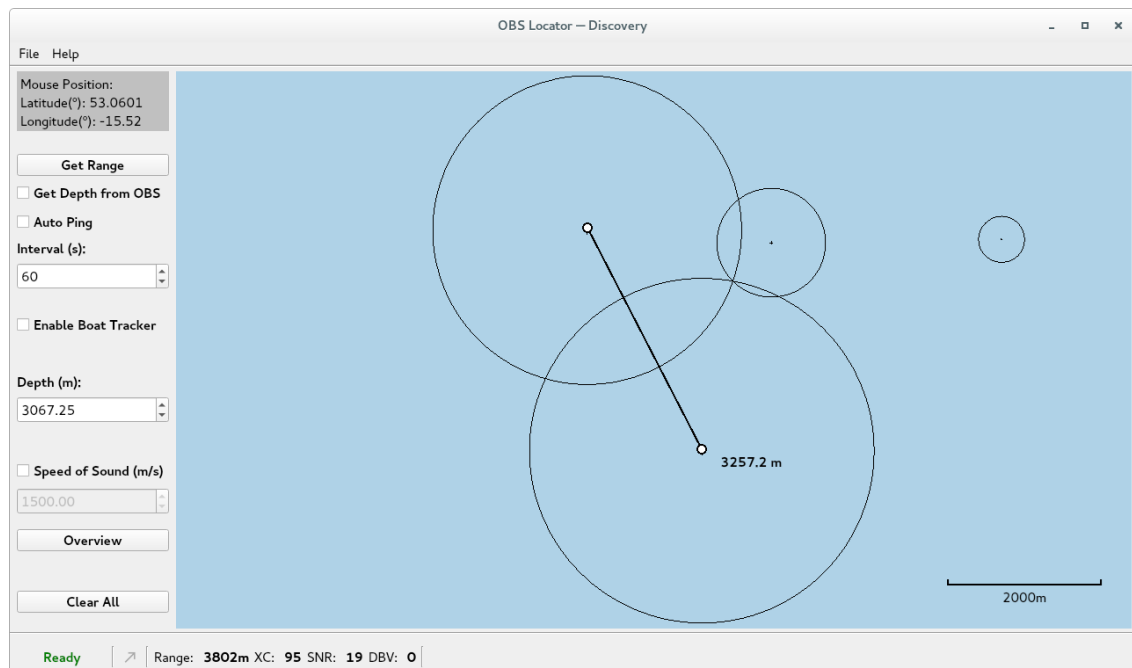

To delete all points at once, right-click on the map and select "Clear Measurement"

## Aquarius Ocean Bottom System

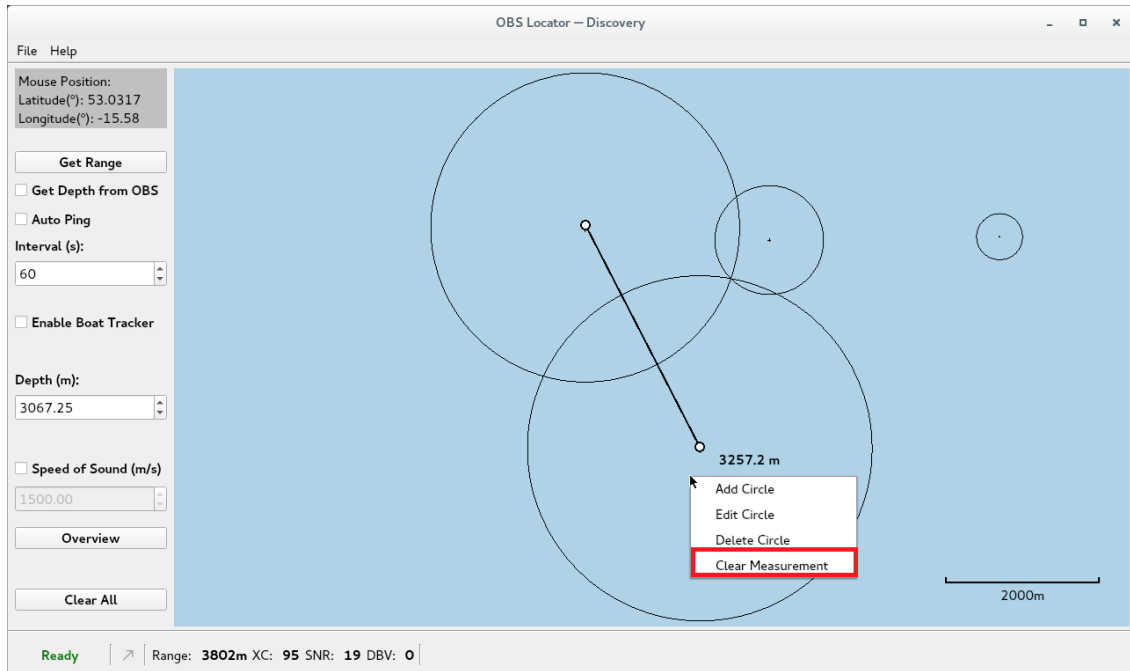

### 9.2.4 Log Files

There are two types of data files generated by the OBS Locator – standard log file (.log) and “Boat Tracker” log file (.btr). The former file stores the parameters of each circle or the location of the OBS, while the latter file stores the location of the boat while the “Boat Tracker” is enabled. Both files are automatically generated and updated, and could be loaded at the same time later on.

#### 9.2.4.1 File Formats

The file name of either file type is the *\*current date\** in *dd-mm-yyyy* format and is saved in the application configuration directory:

|         |   |
|---------|---|
| MacOS   | "~/Library/Preferences/Guralp Systems/Discovery/obs_locator/"         |
| Windows | "C:/Users/<USER>/AppData/Local/Guralp Systems/Discovery/obs_locator/" |
| Linux   | "~/.config/Guralp Systems/Discovery/obs_locator/"                     |

The data in the standard (.log) file has the following formats:

*Date (dd-mm-yyyy), Time (hh:mm:ss), Boat Location (Lat,Lon), Turn-Around-Time (us), Slant Range (m), OBS Depth (m), Speed of Sound (m/s)*

*Date (dd-mm-yyyy), Time (hh:mm:ss), OBS Location: Lat,Lon, Depth: xxxx (m)*



## Aquarius Ocean Bottom System

```
Open 12-10-2019.log Save
~/workspace
# .log is a generic log file in which data for each ping is recorded. The file starts with the header 'Date
Time Lat,Lon dTime Range Depth SoS', which indicates the format of the recorded data on each line. Date (dd-mm-
yyyy), Time (hh:mm:ss), Location (xxx.xxxx,xxx.xxxxx), Turn-Around-Time (us), Range (m), OBS Depth (m), Speed
of sound (m/s). The OBS location (once triangulated) is also recorded in .log file on a separate line with the
Date, Time, OBS Location and Depth. The name of each .log and .btr file should start with a date with dd-mm-
yyyy format. That will allow the two files from the same deployment to be loaded simultaneously. If the header
or any of the data does not hold the specified formats, an error message will be printed.

Date Time Lat,Lon TAT Range Depth SoS
12-10-2019 15:55:42 53.0594,-15.5649 3877760 3148.32 3076 1500
12-10-2019 16:48:1 53.0349,-15.5781 4753320 3804.99 3085 1500
12-10-2019 17:6:42 53.0607,-15.6008 4574546 3670.91 3082 1500
12-10-2019 17:9:7 OBS Location: 53.0549,-15.5723 Depth: 3069m

Plain Text Tab Width: 8 Ln 1, Col 749 INS
```

The data in the “Boat Tracker” (.btr) file has following format:

*Date (dd-mm-yyyy), Time (hh:mm:ss), Location (Lat,Lon)*

```
Open *16-12-2019.btr Save
~/config/Guralp Systems/Discovery/obs_locator
# .btr is a log file of the boat location while the 'Boat Tracker' function is enabled. Each .btr file starts
with the header 'Date Time Lat,Lon' which indicates the format of the recorded data on each line. Date (dd-mm-
yyyy), Time (hh:mm:ss), Location (xxx.xxxx,xxx.xxxxx). If at any point the 'Boat Tracker' is disabled and
later on enabled again, this breakpoint will be recorded as '#break' which would act as an identifier to
distinguish the different trajectories. The name of each .log and .btr file should start with a date with dd-
mm-yyyy format. That will allow the two files from the same deployment to be loaded simultaneously. If the
header or any of the data does not hold the specified formats, an error message will be printed.

Date Time Lat,Lon
16-12-2019 11:40:28 51.3605,-1.16163
16-12-2019 11:40:33 51.3587,-1.16354
16-12-2019 11:40:38 51.3564,-1.16582
16-12-2019 11:40:43 51.3531,-1.16891
16-12-2019 11:40:48 51.35,-1.16627
16-12-2019 11:40:53 51.3463,-1.16379
16-12-2019 11:40:55 51.3443,-1.16323
16-12-2019 11:41:0 51.3442,-1.16198
16-12-2019 11:41:5 51.3455,-1.15886
16-12-2019 11:41:10 51.3473,-1.15654
16-12-2019 11:41:30 51.3471,-1.1554
16-12-2019 11:41:35 51.3473,-1.15255
16-12-2019 11:41:40 51.346,-1.14843
16-12-2019 11:41:45 51.3492,-1.1376
16-12-2019 11:41:50 51.3487,-1.1365
16-12-2019 11:41:55 51.3486,-1.13539
16-12-2019 11:42:0 51.3495,-1.1369
16-12-2019 11:42:5 51.3595,-1.14676
16-12-2019 11:42:10 51.3605,-1.16162
#break

Plain Text Tab Width: 8 Ln 1, Col 700 INS
```



**Note:** Additional comments could be added to either of the files. Comments should be added before the header of the file (“Data Time Lat, Lon...”) and should start with #.

### 9.2.4.2 Save As

Modifications of the data made via any of the methods described in Section 9.2.3 on page **Error! Bookmark not defined.** will not be automatically saved. To save any changes, navigate to the menu bar and click “File” → “Save As” or press Ctrl+S.



**Note:** Always make sure that the name of either of the data type files starts with a date in *dd-mm-yyyy* format.

---

### 9.2.4.3 *Load*

To load a data file, navigate to the menu bar and click “File” → “Open” or press Ctrl+O. Only files with (.log) and (.btr) extension can be loaded.

All the data from a (.log) file will be loaded and visualised except for the Aquarius location (if present).

It is possible to load both (.log) and (.btr) at the same time. To do so, simply select them together when loading the files. The only condition is that the two files are from the same deployment, i.e. the date in the name of the files is the same.

# 10 Recovery procedure

## 10.1 Releasing the ballast

Follow the instructions in Section 7.1.3.5 on page 45 to initiate the release of the ballast.

In case the ballast is not released via acoustic command, the Aquarius releases it when the timer in ULPD, configured in the “OBS Command & Control” expires (see Section 35 on page 37).

## 10.2 Locating the Aquarius on the sea surface

Once the Aquarius reaches the sea surface, the recovery aids (satellite tracker and LED strobe) will be automatically activated by the pressure sensor. Follow the instructions in Section 4.9.1 on page **Error! Bookmark not defined.** to locate the OBS.

## 10.3 Recover the Aquarius and check the time drift

Once the Aquarius is recovered, connect the OBS to the deck unit using the Ethernet cable and switch on the PoE on the deck unit to start powering up the OBS from the deck unit rather than internal batteries. This procedure will reboot the LPC in normal mode with the LAN interface on.

Open the Aquarius webpage and monitor the “PTP Stability” in the “Status” tab. Wait until the stability has a “green” status (>90%).

| PTP Status          |              |                         |                         |                       |                         |
|---------------------|--------------|-------------------------|-------------------------|-----------------------|-------------------------|
| PTP state           | Phase Locked | Last PTP timestamp      | 2019-08-14<br>12:41:59Z | Last PTP lock time    | 2019-08-12<br>07:47:06Z |
| Master IPv4 address | 10.30.255.35 | Master clock class      | PRI_REF_PTP             | Master clock accuracy | < 100ns (0x21)          |
| Network path delay  | 28.6 us      | Network jitter estimate | ± 559 ns                | Network outliers      | 3%                      |
|                     |              |                         |                         | PTP stability         | 100%                    |
|                     |              |                         |                         | Master time source    | GPS                     |

Go to the “Setup” tab and click on “Flush to SD” button to save in the LPC storage the data still in the ULPD buffer. Click on “Stop Recording” button to stop recording in the ULPD.

|             |            |                         |   |        |             |      |
|-------------|------------|-------------------------|---|--------|-------------|------|
| Deploy Mode | Power Save | Auto Center Disable(hr) | 1 | Deploy | Time Offset | -6ms |
| Undeploy    |            | Flush to SD             |   |        |             |      |

Wait until the status shows a good stability for the PTP. Check the calculated offset in either the “Setup” tab of the webpage, or the “Pre-Deploy” tab of the “OBS Command & Control” widget in Discovery, and take note of it.



**Caution:** The offset information is not recorded in the microSD cards.

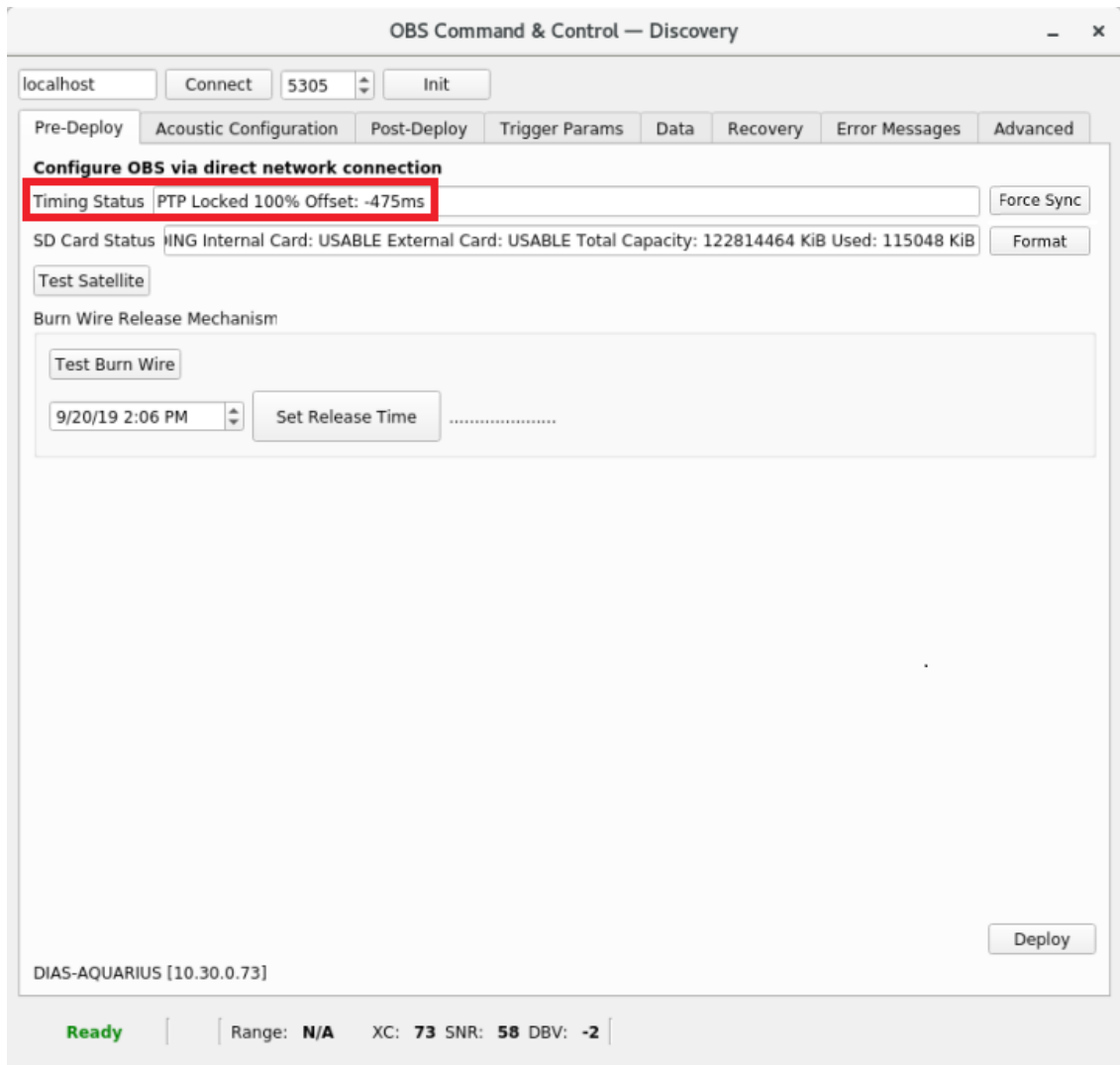

## 10.4 Download the data

In the “Storage” tap of the Aquarius web browser are listed all the miniSEED files recorded during the deployment. Follow the instructions in Section 7.2.5 on page **Error! Bookmark not defined.** to download them.

# 11 Appendix A – Channel names

## 11.1 Data streaming

The table in this section shows the names and codes of the streamed channels. The first character “x” in miniSEED channel code represents the sample rate. The possible values are shown in the table below:

|          |                        |
|----------|------------------------|
| <b>F</b> | ≥ 1000Hz to < 5000Hz   |
| <b>C</b> | ≥ 250 Hz to < 1000Hz   |
| <b>H</b> | ≥ 80Hz to < 250Hz      |
| <b>B</b> | ≥ 10Hz to < 80Hz       |
| <b>M</b> | > 1Hz to < 10Hz        |
| <b>L</b> | ≈ 1Hz                  |
| <b>V</b> | ≈ 0.1Hz                |
| <b>U</b> | ≈ 0.01Hz               |
| <b>R</b> | ≥ 0.0001 Hz to < 0.001 |

| Sensor                               | Component | Digital filter mode | Data streaming   |                  |                       |
|--------------------------------------|-----------|---------------------|------------------|------------------|-----------------------|
|                                      |           |                     | Live stream name | Live Stream code | miniSEED channel code |
| Seismometer (velocity response)      | Vertical  | Acausal             | S1SeisZ          | 1VELZ0           | xHZ                   |
|                                      |           |                     | S1SeisZ          | 1VELZ2           | xHZ                   |
|                                      |           | Causal              | S1SeisZLowLat    | 1VELZC           | xHZ                   |
|                                      | North     | Acausal             | S1SeisN          | 1VELN0           | xHN                   |
|                                      |           |                     | S1SeisN          | 1VELN2           | xHN                   |
|                                      |           | Causal              | S1SeisNLowLat    | 1VELNC           | xHN                   |
|                                      | East      | Acausal             | S1SeisE          | 1VELE0           | xHE                   |
|                                      |           |                     | S1SeisE          | 1VELE2           | xHE                   |
|                                      |           | Causal              | S1SeisELowLat    | 1VELEC           | xHE                   |
| Digital seismic sensor mass position | Vertical  | Acausal             | S1IntZ           | 1INTZ0           | xMZ                   |
|                                      | North     | Acausal             | S1IntN           | 1INTN0           | xMN                   |
|                                      | East      | Acausal             | S1IntE           | 1INTE0           | xME                   |
| MEMS accelerometer                   | Vertical  | Acausal             | S1AccZ           | 1AXLZ0           | xNZ                   |
|                                      |           | Causal              | S1AccZLowLat     | 1AXLZC           | xNZ                   |
|                                      | North     | Acausal             | S1AccN           | 1AXLN0           | xNN                   |

## Aquarius Ocean Bottom System

| Sensor                           | Component               | Data streaming      |                  |                  |                       |
|----------------------------------|-------------------------|---------------------|------------------|------------------|-----------------------|
|                                  |                         | Digital filter mode | Live stream name | Live Stream code | miniSEED channel code |
|                                  | East                    | Causal              | S1AccNLowLat     | 1AXLNC           | xNN                   |
|                                  |                         | Acausal             | S1AccE           | 1AXLE0           | xNE                   |
|                                  |                         | Causal              | S1AccELowLat     | 1AXLEC           | xNE                   |
| Magnetometer                     | Z                       | Acausal             | S1MagZ           | 1MAGZ0           | xFZ                   |
|                                  | N                       | Acausal             | S1MagN           | 1MAGN0           | xFN                   |
|                                  | E                       | Acausal             | S1MagE           | 1IMAGE0          | xFE                   |
|                                  | Yaw                     | Acausal             | S1RotYaw         | 1ROTY0           | xYY                   |
|                                  | Pitch                   | Acausal             | S1RotPitch       | 1ROTP0           | xYP                   |
|                                  | Roll                    | Acausal             | S1RotRoll        | 1ROTR0           | xYR                   |
| Temperature                      | Sea temperature chain   | Acausal             | S1TemprSea       | 1TSEA0           | xKO                   |
|                                  | Sensor temperature      | Acausal             | S1TemprB         | 1TMPB0           | xKO                   |
| Humidity within sensor enclosure |                         | Acausal             | S1HumidB         | 1HUMB0           | xIO                   |
| Pressure                         | Within sensor enclosure | Acausal             | S1Pressure       | 1PRSR0           | xDI                   |
|                                  | External sea            | Acausal             | S1ExtPressure    | 1PRSR1           | xDO                   |
|                                  | ParoScientific          | Acausal             | S1APG            | 1PRSR2           | xDU                   |
| PLL clock offset                 |                         | Acausal             | S1PLLOffset      | 1PLL0            | xYO                   |
| Sensor power                     |                         | Acausal             | S1Power          | 1PWR0            | xEO                   |
| Sensor input voltage             |                         | Acausal             | S1Voltage        | 1VOLT0           | xE1                   |
| STA/LTA                          | STA                     | Acausal             | S1STAZ           | 1STAZ0           | xZ0                   |
|                                  | LTA                     | Acausal             | S1LTAZ           | 1LTAZ0           | xZ1                   |
|                                  | Ratio                   | Acausal             | S1RatioZ         | 1RatZ0           | xZ2                   |

## 11.2 Data recording

| Sensor                          | Component | Data recording      |                  |                       |
|---------------------------------|-----------|---------------------|------------------|-----------------------|
|                                 |           | Digital filter mode | Data Record name | miniSEED channel code |
| Seismometer (velocity response) | Vertical  | Acausal             | S1SeisZFR        | CHZ                   |
|                                 | North     | Acausal             | S1SeisNZFR       | CHN                   |
|                                 | East      | Acausal             | S1SeisEFR        | CHE                   |

## Aquarius Ocean Bottom System

| Sensor                               | Component               | Data recording      |                  |                       |
|--------------------------------------|-------------------------|---------------------|------------------|-----------------------|
|                                      |                         | Digital filter mode | Data Record name | miniSEED channel code |
| Digital seismic sensor mass position | Vertical                | Acausal             | S1IntZFR         | MMZ                   |
|                                      | North                   | Acausal             | S1IntNFR         | MMN                   |
|                                      | East                    | Acausal             | S1IntEFR         | MME                   |
| Temperature                          | Sea temperature chain   | Acausal             | S1TemprSeaFR     | LKO                   |
|                                      | Sensor temperature      | Acausal             | S1TemprBFR       | MKO                   |
| Humidity within sensor enclosure     |                         | Acausal             | S1HumidBFR       | MIO                   |
| Pressure                             | Within sensor enclosure | Acausal             | S1PresFR         | MDI                   |
|                                      | External sea            | Acausal             | S1ExtPresFR      | MDO                   |
|                                      | ParoScientific          | Acausal             | S1APGFR          | MDU                   |
| PLL clock offset                     |                         | Acausal             | S1PLLOffsetFR    | MYO                   |
| Sensor power                         |                         | Acausal             | S1PowerFR        | LE3                   |
| Sensor input voltage                 |                         | Acausal             | S1VoltageFR      | ME4                   |
| STA/LTA                              | STA                     | Acausal             | S1STAZFR         | LZ0                   |
|                                      | LTA                     | Acausal             | S1LTAZFR         | LZ1                   |
|                                      | Ratio                   | Acausal             | S1RatioZFR       | LZ2                   |

# 12 Appendix B – Connector pin-outs

## 12.1 OBS – APG/Hydrophone and Burn-Wire

This is an SubConn Micro Circular 8-way socket connector.

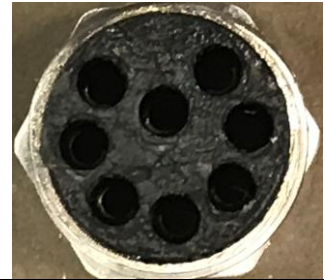

| Pin | Function                            |
|-----|-------------------------------------|
| 1   | Burn-Wire DC+                       |
| 2   | Burn-Wire DC-                       |
| 3   | APG FRQ Temperature                 |
| 4   | APG FRQ Pressure                    |
| 5   | APG RS-232 Tx / Hydrophone Signal + |
| 6   | APG RS-232 Rx / Hydrophone Signal - |
| 7   | APG RS-232 Gnd / Hydrophone Gnd     |
| 8   | APG V+ / Hydrophone Power           |



Wiring details for the compatible plug, as seen from the cable end (*i.e.* when assembling).



## 12.2 OBS – Ethernet and Serial RS-232

This is an Seacon Hummer 18-way socket connector.



| Pin | Function        |
|-----|-----------------|
| 1   | Ethernet C+     |
| 2   | Ethernet C-     |
| 3   | Ethernet D+     |
| 4   | Ethernet D-     |
| 5   | Ethernet A+     |
| 6   | Ethernet A-     |
| 7   | Ethernet B+     |
| 8   | Ethernet B-     |
| 9   | LPC RS-232 Tx   |
| 10  | ULPD RS-232 Tx  |
| 11  | ULPD RS-232 Rx  |
| 12  | LPC RS-232 Rx   |
| 13  | External power+ |
| 14  | External power+ |
| 15  | External power+ |
| 16  | External power- |
| 17  | External power- |
| 18  | External power- |

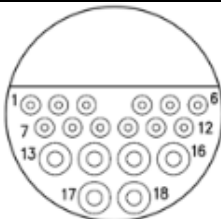

Wiring details for the compatible socket, as seen from the cable end (*i.e.* when assembling).

## 12.3 OBS – Battery charger

These are standard 32-way military-specification bayonet plug.



| Pin | Function                                   | Pin | Function                                   | Pin | Function                                 |
|-----|--|-----|--|-----|--|
| A   | P1 T4 CHARGE (PACK 1 4S MAIN + CONNECTION) | M   | P0 T4 CHARGE (PACK 0 4S MAIN +CONNECTION)  | Z   | P0 T1 SENSE LINK CONNECTION (PACK 0 1S+) |
| B   | P1 T4 CHARGE (PACK 1 4S MAIN + CONNECTION) | N   | P0 T4 CHARGE (PACK 0 4S MAIN +CONNECTION)  | a   | P0 T2 SENSE LINK CONNECTION (PACK 0 2S+) |
| C   | TEMPERATURE SENSE POSITIVE                 | P   | P2 T2 SENSE LINK CONNECTION (PACK 2 1S+)   | b   | P0 T4 SENSE LINK CONNECTION (PACK 0 4S+) |
| D   | P2 T0 CHARGE (PACK 2 1S MAIN - CONNECTION) | R   | P1 T0 CHARGE (PACK 1 1S MAIN - CONNECTION) | c   | P0 T0 SENSE LINK CONNECTION (PACK 0 1S-) |
| E   | P2 T0 CHARGE (PACK 2 1S MAIN - CONNECTION) | S   | P1 T0 CHARGE (PACK 1 1S MAIN - CONNECTION) | d   | P2 T1 SENSE LINK CONNECTION (PACK 2 1S+) |
| F   | P2 T0 SENSE LINE CONNECTION (PACK2 1S-)    | T   | P1 T2 SENSE LINK CONNECTION (PACK 1 1S+)   | e   | P1 T1 SENSE LINK CONNECTION (PACK 1 1S+) |
| G   | P2 T4 CHARGE (PACK 2 4S MAIN + CONNECTION) | U   | P1 T4 SENSE LINK CONNECTION (PACK 1 4S+)   | f   | P1 T3 SENSE LINK CONNECTION (PACK 1 3S+) |
| H   | P2 T4 CHARGE (PACK 2 4S MAIN + CONNECTION) | V   | P1 T0 SENSE LINK CONNECTION (PACK 1 1S-)   | g   | P2 T3 SENSE LINK CONNECTION (PACK 2 3S+) |
| J   | P0 T0 CHARGE (PACK 0 1S MAIN - CONNECTION) | W   | TEMPERATURE SENSE NEGATIVE                 | h   | 24 V DC CHARGE ENABLE +                  |
| K   | P0 T0 CHARGE (PACK 0 1S MAIN - CONNECTION) | X   | TEMPERATURE SENSE SIGNAL                   | j   | 24 V DC CHARGE ENABLE -                  |
| L   | P0 T3 SENSE LINK CONNECTION (PACK 0 3S+)   | Y   | P2 T4 SENSE LINK CONNECTION (PACK 2 4S+)   |     |  |

## Aquarius Ocean Bottom System



Wiring details for the compatible socket, as seen from the cable end (*i.e.* when assembling).

# 13 Appendix C – Deployment check-list

This deployment checklist is provided for information only. Refer to Section 9 on page **Error! Bookmark not defined.** for full details of the deployment procedure.

Aquarius S/N: \_\_\_\_\_

Acoustic modem address: \_\_\_\_\_

Acoustic modem UID: \_\_\_\_\_

Deployment location: Latitude \_\_\_\_\_,

Longitude: \_\_\_\_\_

Deployment date: \_\_\_\_/\_\_\_\_/\_\_\_\_\_

| Operation   | Check |
|---|-------|
| Fully charge the batteries inside the Aquarius (see Section 5.4 on page 23).  |       |
| Screw the charger pressure cap back in.   |       |
| Attach the ballast to the Burn-Wire system (see Section 8.2 page 65).   |       |
| Connect the Seacon Hummer series connector on the Aquarius and the Ethernet and console connectors to the Deck Unit.  |       |
| Remove the magnetic off plug and fit the vent cap <u>with the O-ring</u> and the sacrificial anode / If the cap with the O-ring is already in place and the system is already on, switch PoE on, reset it using the <i>System Reset</i> button in the <i>OBS On Deck</i> tab of <i>OBS Command &amp; Control</i> widget.  |       |
| In the Deck Unit, switch the PoE on.  |       |
| Check PTP lock either from the LPC web page ( <i>Status</i> tab, <i>PTP status</i> section, <i>PTP stability</i> cell) or from the <i>OBS Command &amp; Control</i> widget / <i>Pre-Deploy</i> tab / <i>Timing Status</i> . If <i>No Master</i> is shown in the above fields, check PTP network configuration in the LPC (see Section 7.2.2 on page 48) or GPS fix in the PTP server. |       |
| Check whether recording of non FR channels for Sensor 0 and Sensor 1 are disabled in the LPC web page / <i>Data Record</i> tab (see Section 7.2.4 on page 52).  |       |
| Select all the FR channels on Sensor1 to be recorded from the LPC web page / <i>Data Record</i> tab.  |       |

| Operation   | Check |
|---|-------|
| If changes were made in the LPC web page / <i>Data Record</i> tab, reboot the LPC.  |       |
| In the LPC web page / <i>Trigger</i> tab, set as trigger source <i>SIRatioZFR</i> and choose appropriate values for STA/LTA parameters. Set the Whalesong Sender as trigger destination. Set the threshold to 0 (see Section 7.2 on page <b>Error! Bookmark not defined.</b> ). This will disable triggering until the OBS is on the seabed. At that point this parameter can be modified via acoustics, if a buoy unit is present. |       |
| Download the Dataless file from the <i>Storage</i> tab of the LPC web page.   |       |
| Set the bottom acoustic modem address in the <i>Network</i> tab of the LPC web page ( <i>Local modem address</i> ) and take note of it. In case of an installation with a buoy unit on the surface, set also the surface acoustic modem address ( <i>Remote modem address</i> in the LPC web page, see Section 7.2.6 on page 60).   |       |
| In the LPC web page, <i>Network</i> tab, set temporarily the acoustic modem <i>Power level &amp; gain</i> to <i>Suitable in air</i> (see Section 7.2.6 on page 60)  |       |
| Test the Burn-Wires via acoustic command from the <i>Recovery</i> tab in the <i>OBS Command &amp; Control</i> widget (see Section 7.1.3.5 on page 45).  |       |
| In the LPC web page, <i>Network</i> tab, set the acoustic modem <i>Power level &amp; gain</i> to a depth suitable for the specific installation (see Section 7.2.6 on page 60).   |       |
| <i>Quick format</i> the SD cards either from the LPC web page ( <i>Storage</i> tab) or from the <i>Pre-Deploy</i> tab of the Discovery <i>OBS Command &amp; Control</i> widget ( <i>Format</i> button).   |       |
| Check live data from sensors in the Discovery <i>Live View</i> (see Section 7.1.2 on page 30).  |       |
| Test Burn-Wires from ULPD using the Discovery <i>OBS Command &amp; Control</i> widget, <i>OBS On Deck</i> tab, <i>Test Burn Wire</i> button (see Section 7.1.3.2 on page 36).   |       |
| Test the satellite tracker and LED strobe activating them from the Discovery <i>OBS Command &amp; Control</i> widget, <i>OBS On Deck</i> tab, <i>Test Satellite</i> button.   |       |

Aquarius Ocean Bottom System

| Operation   | Check |
|---|-------|
| Set the time for the backup Burn-Wires that would be activated by the ULPD timer. Use the Discovery <i>OBS Command &amp; Control</i> widget, <i>OBS On Deck</i> tab for this task (see Section 7.1.3.2 on page 37).   |       |
| If the <i>Offset</i> in <i>OBS Command &amp; Control</i> / <i>OBS On Deck</i> tab / <i>Timing Status</i> is not 0ms force a time synchronization using the button <i>Force Sync</i> .   |       |
| Wait until the message <b>Good to go</b> is displayed in the <i>OBS On Deck</i> tab in <i>OBS Command &amp; Control</i> (see Section 7.1.3.2 on page 35).   |       |
| DEPLOY the Aquarius either from the LPC web page (see Section 7.2.7 on page 61) or from the Discovery <i>OBS Command &amp; Control</i> widget, <i>OBS On Deck</i> tab, <i>Deploy</i> button.  |       |
| Switch off the PoE in the Deck Unit and unplug the Seacon Hummer series connector.  |       |
| Plug the Seacon Hummer series dummy cap.  |       |
| Fit the central block of buoyancy and mount the lifting frame.  |       |
| Deploy the Aquarius in the water.   |       |
| Range the Aquarius while is descending towards the seabed. For this task, you could either use the <i>Modem Ping</i> button in the <i>OBS Command &amp; Control</i> widget / <i>Post-Deploy</i> tab or the <i>OBS location</i> widget (see Section 9.2.2.1 on page 78). |       |
| Click on the <i>Status</i> button in the <i>OBS Command &amp; Control</i> widget / <i>Post-Deploy</i> tab to show the Aquarius depth (inferred from the Keller pressure sensor data) and other SoH info.  |       |
| When the Aquarius will have reached the seabed, wake up the LPC asking for the Aquarius ID or for the SEED ID using the <i>OBS Command &amp; Control</i> widget, <i>Post-Deploy</i> tab.  |       |
| Force a centring via acoustics using the button <i>Perform Recentre</i> in the <i>Post-Deploy</i> tab of the <i>OBS Command &amp; Control</i> widget (see Section 40 on page 43).   |       |
| Check re-centring status using the button <i>Get Recentring Status</i> in the <i>Post-Deploy</i> tab of the <i>OBS Command &amp; Control</i> widget.  |       |

## Aquarius Ocean Bottom System

| Operation  | Check |
|--|-------|
| When centring is completed, flush data from the ULPD to the LPC microSD cards using the <i>Flush Data</i> button in <i>Post-Deploy</i> tab of the <i>OBS Command &amp; Control</i> widget. |       |
| Retrieve data via acoustic comms to check sensor performance (see Section 7.1.3.4 on page 44).   |       |

# 14 Appendix D – Recovery check-list

This recovery checklist is provided for information only. Refer to Section 10 on page **Error! Bookmark not defined.** for full details of the recovery procedure.

Aquarius S/N: \_\_\_\_\_

Acoustic modem address: \_\_\_\_\_

Acoustic modem UID: \_\_\_\_\_

Deployment location: Latitude \_\_\_\_\_,

Longitude: \_\_\_\_\_

Recovery date: \_\_\_\_/\_\_\_\_/\_\_\_\_\_

Time offset at the recovery: \_\_\_\_\_ms

| Operation  | Check |
|--|-------|
| Release the ballast using the <i>Recovery</i> tab in the <i>OBS Command &amp; Control</i> widget. 900 seconds, as burning time, should be sufficient.  |       |
| Check the <b>Status in the OBS Command &amp; Control widget / Post-Deploy tab</b> to monitor the power going into the Burn-Wire release system.  |       |
| <i>Status</i> can also be used to check the Aquarius depth while ascending to the surface.   |       |
| When on the surface, LED will start working if it's dark. The satellite tracker will send messages with its position to the first responders set in the web portal.  |       |
| Bring the Aquarius on board.   |       |
| Connect the Seacon Hummer series connector on the Aquarius and the Ethernet and console connectors to the Deck Unit.   |       |
| In the Deck Unit, turn the PoE on.   |       |
| Open the <i>OBS Command &amp; Control</i> widget, <i>Pre-deploy</i> tab, to check the clock offset and <u>take note of it</u> .  |       |
|  <b>Note:</b> The offset will be correct only when the PTP stability is close to 100%. <b>The offset is not stored in the SD cards.</b> |       |
| Download data from the Aquarius the <i>Storage</i> tab in the LPC web server (see Section 7.2.5 on page 55).   |       |



## Aquarius Ocean Bottom System

| <b>Operation</b>   | <b>Check</b> |
|--|--------------|
| Before storing back the Aquarius for long time, charge batteries at least at 50% and plug the magnetic switch. |              |

## 15 Appendix E – Acoustic Modem link

### 15.1 Description of Operation

The acoustic data transmission link between an Aquarius and the surface comprises of two nodes; referred to here as a *Surface* (Ship based Deck Unit or Buoy System) and *Bottom* (Aquarius or Aquarius) modems. The *Bottom* modem type and capability varies between Aquarius and Aquarius, but the principles of operation and fault finding are the same.

Each modem, *Surface* or *Bottom*, has a unique identification number which is set at the factory; this is rarely used directly. Acoustic modems have a more convenient user configurable *Acoustic Modem Address* which is used to direct communications to correct nodes.



**Caution:** It is essential to know the *Acoustic Modem Address* of the modem you wish to communicate with. **Be sure to note the Address of an Aquarius before deployment.**

Each communication node has the concept of *Local* and *Remote*. The *Local Acoustic Modem Address* is the address of the modem at node you are directly interacting with; the *Remote Acoustic Modem Address* is the address of the modem you wish to communicate with acoustically.

There are two types of acoustic transmission; *Commands* and *Data*. *Commands* are modem only communications pertaining to the operation, configuration and status of the acoustic modems themselves. The system (*e.g.* Aquarius, Buoy system or Deck unit) attached to a modem that has a *Command* directed at it is not aware that an acoustic transmission has taken place (and will not wake up if asleep, for example). *Data* transmissions are acoustic transmissions that require interaction with, or a response from the attached *Surface* or *Bottom* systems. Setting a time for the backup burn wire operation, commanding an OBS to perform re-centring, obtaining seismic data from an OBS and an OBS informing a *Surface* system of a seismic event are all examples of acoustic *Data* transmissions.

*Commands* are shorter and more robust acoustic transmissions than *Data* transmissions. Therefore, it is good practice to make first contact with a deployed OBS with a *Command* to verify the quality of an acoustic link.

*Data* transmissions (sent with the *MDFT* command) are typically much longer than *Commands*. Each *Data* transmission frame is split up into multiple sub-frame transmissions, up to 16 per frame. The number of sub-frames required to send a given packet of data depends on the bitrate. Data packets to be transferred between *Surface* and *Bottom* nodes are always sized to fit within one acoustic transfer frame,

regardless of bitrate. Larger transmissions are split into smaller packets to ensure this.

---

## 15.1.1 Modem Configuration

This manual is not intended to serve as a reference for the acoustic modem protocol; a subset of possible configuration options and parameters is included, limited to those which are most likely to require alteration during the operation of the Aquarius and associated systems.

These parameters fall into three categories; *Power & Gain*, *Delay* and *Bitrate & Retries*.

---

### 15.1.1.1 Power & Gain

In order for two acoustic modem nodes to communicate, the strength of the acoustic signals they transmit and the sensitivity to incoming signals being received must be appropriate for the parameters of the installation.

---

#### Power

There are two relevant configuration parameters for setting power levels of acoustic transmission in a modem: *Start Power Level (SPL)* and *Telemetry Power Level (TPL)*. These must be set at an appropriate level for the particular depth of water. It is important to note that more power does not always result in a stronger acoustic link, especially in shallow water scenarios. Higher transmission power increases the likelihood of destructive acoustic reflections and saturation at the receiving node. Instead a sufficient power level should be chosen.

The selection of power parameters should be performed using the *OBS Command & Control* window for the *Surface* modem, and the *Bottom* modem if the OBS has already been deployed. The *Acoustic Configuration* tab contains controls for setting power, gain and other parameters dependant on depth under *Depth Configuration* (see Section 7.1.3.3 on page 38).

The depth related power and gain settings should be set *Locally* in the *Bottom* OBS node before deployment via the LPC web interface, "Network" tab (see Section 7.2.6 on page **Error! Bookmark not defined.**).

It is also possible to read and set these parameters manually using the *Configuration Status (CS)* command (see Section 15.2 on page **Error! Bookmark not defined.**). This should only be attempted with support from Güralp.

---

#### Gain

In addition, it is possible to set the gain of acoustic signals as they are received at a modem. This is known as the *Linear Gain (LG)* parameter. It is desirable to set *LG* as low as possible yet as high as necessary. Too high a gain setting will result in saturation and increased noise (lower signal to noise ratio). Too low a gain will result in a weak acoustic link and, in the worst case, losing communication with an OBS *Bottom* node altogether.



**Warning:** While most acoustic parameters can be corrected if incorrectly set; setting *Linear Gain (LG)* too low for a given depth may result in **permanently** losing communications with a deployed OBS. Exercise special caution when setting or changing *LG*.

The selection of *LG* should be performed using the Discovery *OBS Command & Control* window for the *Surface* modem, and the *Bottom* modem if the OBS has already been deployed. The *Acoustic Configuration* tab contains controls for setting power, gain and other parameters dependant on depth under *Depth Configuration* (see Section 7.1.3.3 on page 38).

The depth related power and gain settings should be set *Locally* in the *Bottom* OBS node before deployment via LPC web interface. This is especially important for *LG*, "Network" tab (see Section 7.2.6 on page **Error! Bookmark not defined.**).

It is also possible to read and set these parameters manually using the *Configuration Status (CS)* command (see Section 15.2 on page **Error! Bookmark not defined.**). This should only be attempted with support from Güralp.

---

### 15.1.1.2 Delays

---

#### Receiver Wait

The primary delay parameter, that has the most impact on the success of acoustic transmissions, is *Receiver Wait* or *RXW*. *RXW* defines the amount of time an acoustic modem will wait for a response from the receiving node for.

The correct delay setting depends exclusively on the distance between two communicating acoustic modems (slant range). This is dictated by the installation depth of the OBS, apart from situations which require a large ratio of lateral distance to depth (these should be avoided as much as possible).

The depth related *RXW*, along with *NPL*, *TPL* and *SPL*, should be set *Locally* in the *Bottom* OBS node before deployment via LPC web interface, "Network" tab (see Section 7.2.6 on page **Error! Bookmark not defined.**).

In the surface modem *RXW* should be set, along with *NPL*, *TPL* and *SPL*, in the depth configuration section of the *Acoustic Configuration* tab of the Discovery *Command & Control* window (see Section 7.1.3.3 on page 38). Using the same tab of the *OBS Command & Control* widget it is also possible to change *RXW* in the bottom modem via acoustic command.

---

#### Local Modem Delays

Local modem delays define the timings of the interactions between a modem and the attached system (*Surface* or *Bottom/OBS*). These delays only impact *Data* transmissions with the *MDFT* command. None of the local modem delays should require alteration during the deployment, operation or recovery of an Aquarius. Changing these parameters should only be attempted with guidance from Güralp.

*Data Delay* or *DD* defines the time delay between the end of one sub-frame transmission and the beginning of the next.

*Modem Delay* or *MD* defines the maximum time that the recipient modem of a request for data will wait before sending a reply. This allows the attached system to provide data to the modem for the response. It takes effect when the responding modem does not already have data to send.

*Uplink Delay* or *UD* defines the time that the recipient modem of a request for data will wait before sending a reply in the case of data having already been loaded for the response.

*Inter Character Time* or *ICT* is the timeout implemented by the recipient modem of a request for data before automatically sending the response. It is applied after the first character is sent serially from the associated system.

All of the local modem delays for the *Surface* and *Bottom* modems can be read and set via the *Modem Delays* section of the *Acoustic Configuration* tab in the *OBS Command & Control* window in Discovery.

It is also possible to read and set these parameters manually using the *Modem Status (MS)* command (see Section 15.2 on page **Error! Bookmark not defined.**). This should only be attempted with support from Güralp.

---

### 15.1.1.3 Bitrate & Retries

---

#### Bitrate

For *Data* transmissions it is possible to define the bitrate (*TS*) that data sub-frames will be transmitted at. Higher bitrates allow a given packet of data to be transferred faster and with fewer sub-frames, but in certain conditions it increases the risk of the recipient modem not successfully receiving the sub-frame and discarding it.



**Note:** The setting of bitrate does not affect *Commands*

The *Data* transmission bitrate should be set in via the *Acoustic Baud Rate* section in the *Acoustic Configuration* tab of the *OBS Command & Control* window (see Section 7.1.3.3 on page 39). The optimal bitrate setting is the highest value that only infrequently causes lost sub-frames.



**Warning:** Decreasing the bitrate in the OBS modem, when it is not needed, wastes energy. The user should always aim to the highest bit rate possible to optimize the energy per bit during acoustic data transfer.

It is also possible to set the bitrate manually by changing the *Telemetry Scheme* or *TS* parameter using the *MS* command (see Section 15.2 on page **Error! Bookmark not defined.**).



**Note:** It is possible, and sometimes desirable, to set different bitrates (*TS*) in the *Surface* and *Bottom* modems, usually with the surface modem set to a slower bitrate.

## Master Retries

In the case of *Data* transmission sub-frames not successfully received following a request for data, the requesting modem can re-request specific failed sub-frames. This feature allows the data bitrate to be increased without loss of connectivity.

This is set via the *Master Retries (MR)* parameter (not to be confused with the *MR* or *Measure Range* command) using the *MS* command (see Section 15.2 on page **Error! Bookmark not defined.**). It is set to an appropriate value by default and should not require alteration.

## 15.2 Sonardyne Debugger

Discovery offers a useful tool for troubleshooting called “Sonardyne Debugger”. It allows to test the functionalities of the acoustic modem.

In Discovery select the Aquarius and click on “Edit” → “Sonardyne Debugger” to launch the interface.

| System    | Name           | Serial#      | Connection Type     | LAN Address |
|-----------|----------------|--------------|---------------------|-------------|
| Aquarius  | AQU-755C       | 30044        | (AQU-755C)          | 10.30.0.88  |
| Aquarius  | AQU-315B       | 12635        | (AQU-315B)          | 10.30.0.32  |
| Aquarius  | AQU-555C       | 21852        | (AQU-555C)          | 10.30.0.103 |
| Aquarius  | AQU-001E5A     | 7770         | (AQU-001E5A)        | 10.30.0.85  |
| Certimus  | CERT-CC5A      | 52314        | (CERT-CC5A)         | 10.30.0.102 |
| Certimus  | CERT-F85C      | 63580        | (CERT-F85C)         | 10.30.0.62  |
| Discovery | Ojczysta       | 3417EBDFD616 | (DISC-3417EBDFD616) | 10.30.0.33  |
| Discovery | aquarius-demo1 | 4C5262264CEC | (DISC-4C5262264CEC) | 10.30.0.41  |
| EAM       | eam3467        | 3467         | (eam3467)           | 10.30.0.47  |
| EAM       | eam2887        | 2887         | (eam2887)           | 10.30.0.42  |
| Fortimus  | FMUS-545A      | 21594        | (FMUS-545A)         | 10.30.0.18  |
| Fortimus  | FMUS-9059      | 36953        | (FMUS-9059)         | 10.30.0.58  |

The “Sonardyne Debugger” can be used either in a Discovery installed in a PC or a Deck Unit connected via serial to a surface modem or in a remote Discovery, connected via TCP/IP to the Discovery connected via serial to the surface modem (i.e. Discovery onshore that connects via satellite link to the Discovery installed on the buoy PC).

## Aquarius Ocean Bottom System

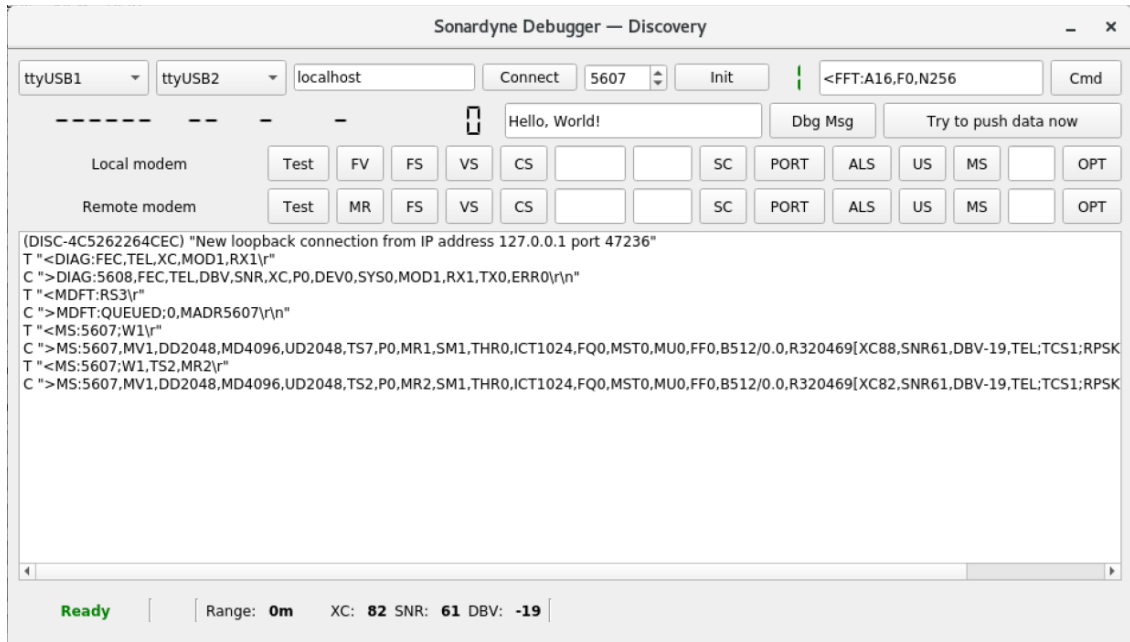

The top section of the window is used to establish the serial connection to the modem and the TCP/IP connection to the Discovery physically connected to the modem. The following screenshot shows a configuration in a Discovery in a deck unit, so connected by serial to the surface modem. The hostname used in this case is "localhost". Press the "Connect" button to establish a connection to the local Discovery at IP 127.0.0.1. Wait for the status at the bottom-left of the window to be **Ready**.

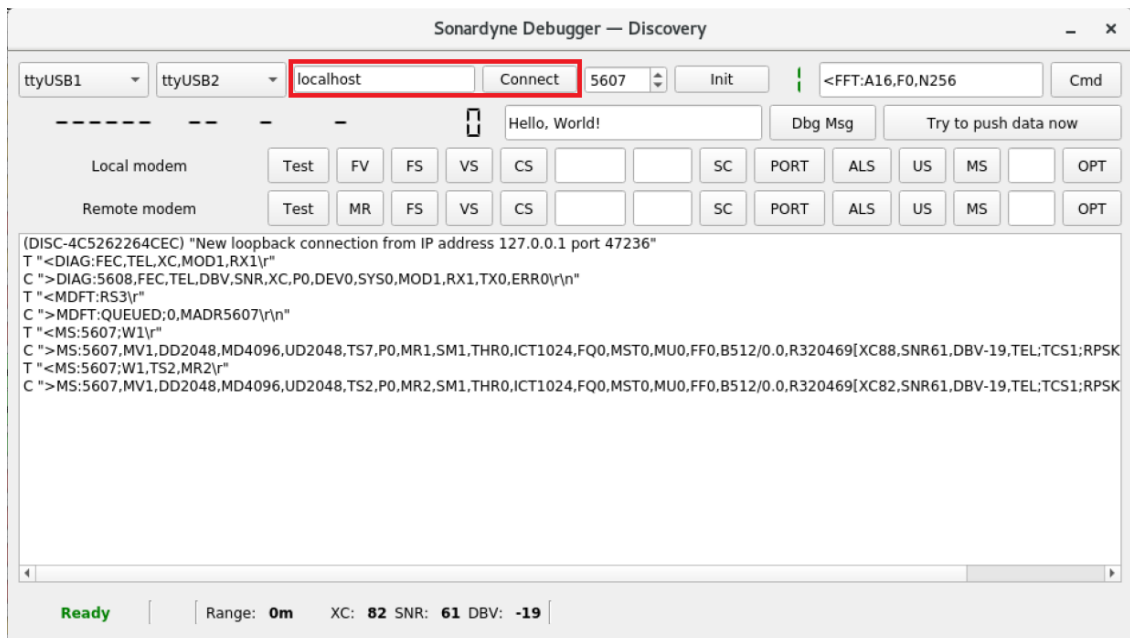

Use the drop down menus at the top-left to select the PC serial ports connected to the "Command" and "Data" ports of the surface modem. These ports are used in the modem for console commands and data transmission respectively.

## Aquarius Ocean Bottom System

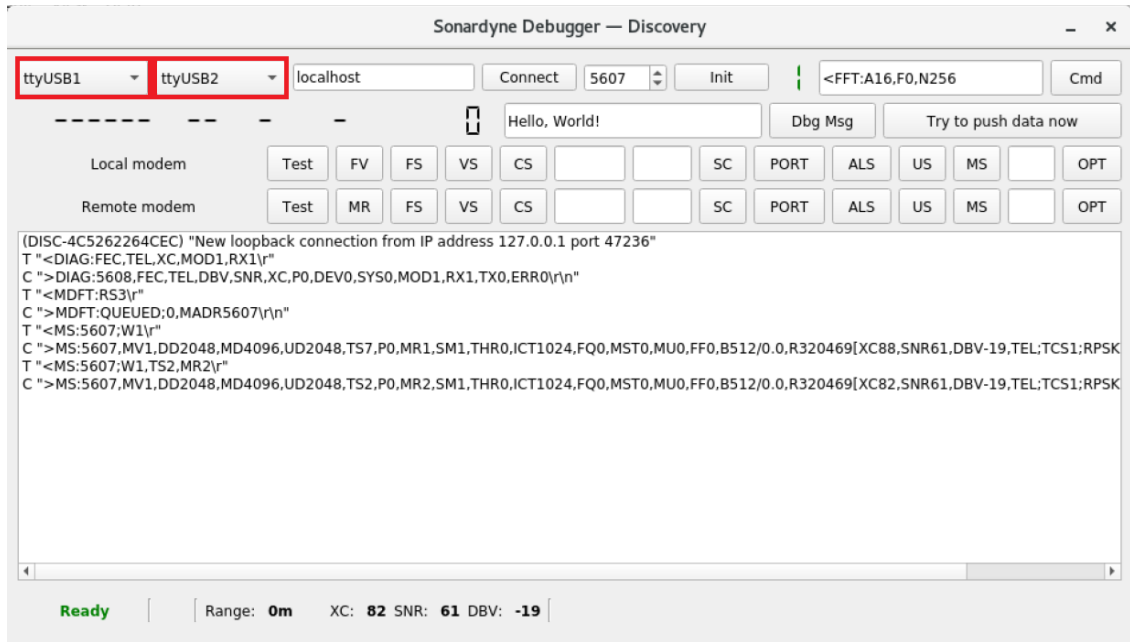

**Note:** In Windows use the Device Manager to determine the ports. In Linux use command `dmesg | grep ttyS` or `dmesg | grep ttyUSB` (in case you are using USB to serial converters) to show available ports.

The pre-selected ports are saved in the config.ini file (see Section 16 on page **Error! Bookmark not defined.**).

In case of a Sonardyne Debugger in a remote Discovery, insert the WAN or LAN IP address of the PC where the Discovery, physically connected to the surface modem, is installed and click the "Connect" button. As shown in the screenshot below, both the serial ports drop down menu will be blanked.

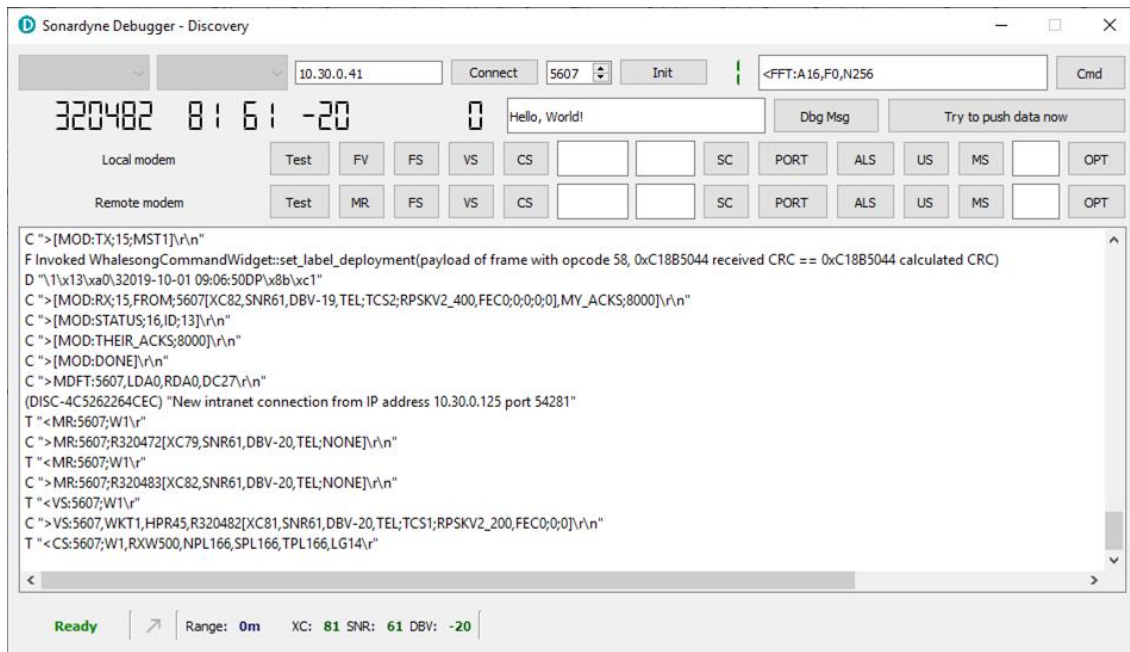



## Aquarius Ocean Bottom System

Type in the acoustic address of the remote acoustic modem.

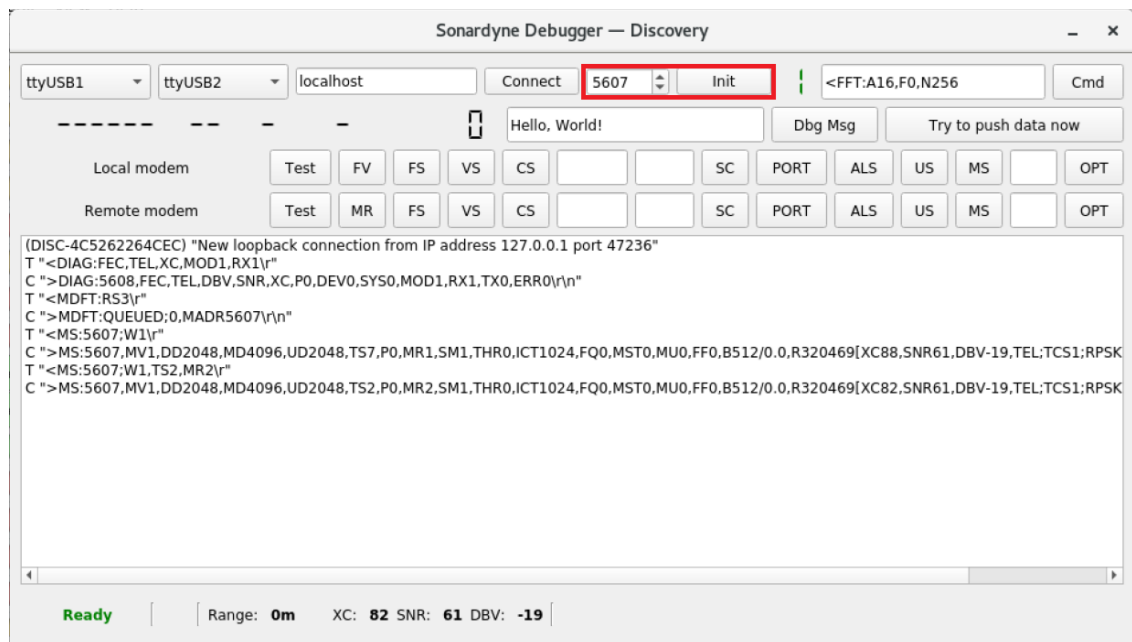

After this, press the "Init" button to initialise the surface acoustic modem. Only after these steps the end user can start sending commands.

Manual commands can be sent using the field at the top-right. Click on "Cmd" button to send the command.

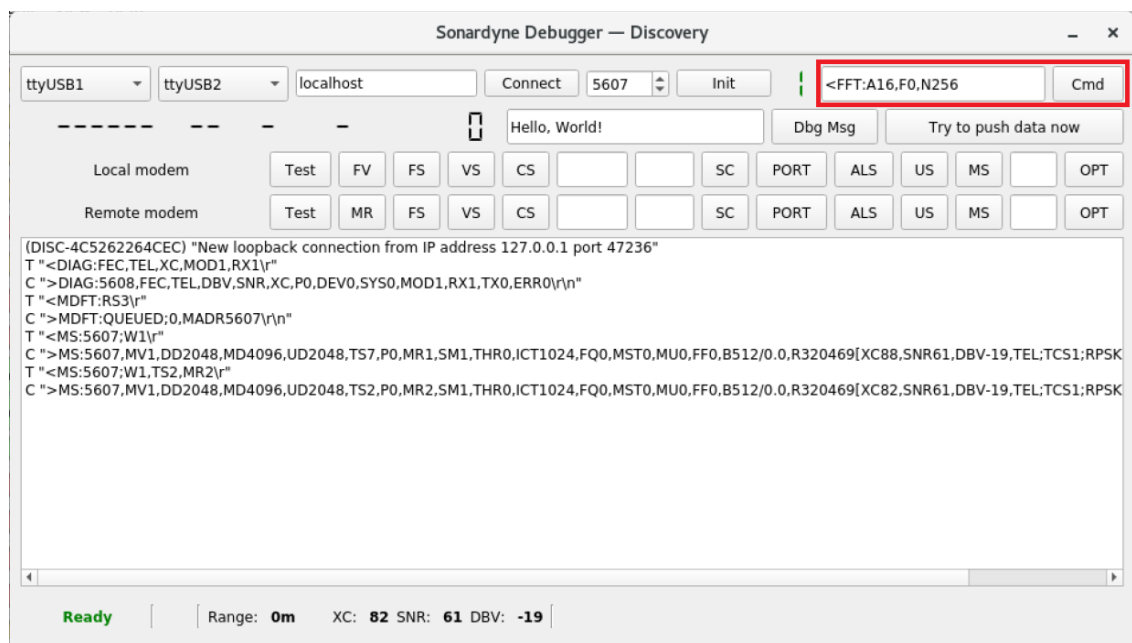

For quick access to most common commands use the buttons below:

## Aquarius Ocean Bottom System

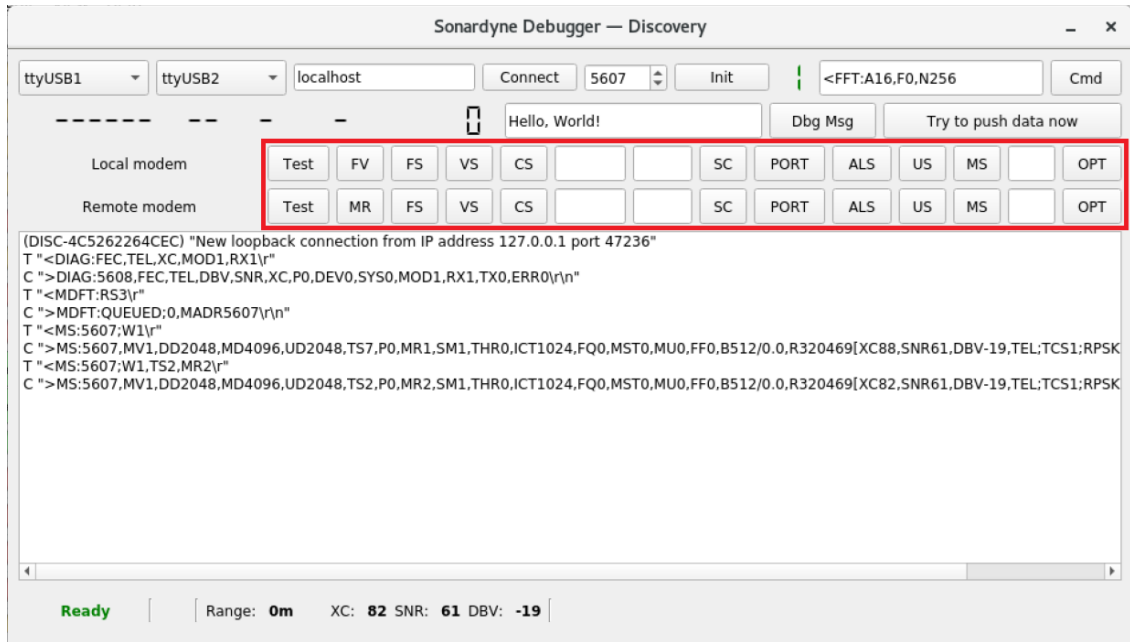

- MR: Measure Range.
- CS: Configuration Status.
- MS: Modem Status.



**Note:** The remaining buttons are used in the factory by the manufacturer for development reasons only.

The bottom panel shows commands sent and received. Each line is marked with a letter that distinguishes the type of instruction:

- T: Command transmitted to the “Command” port.
- C: Answer from the surface modem received on the “Command” port.
- D: Data received on “Data” port.

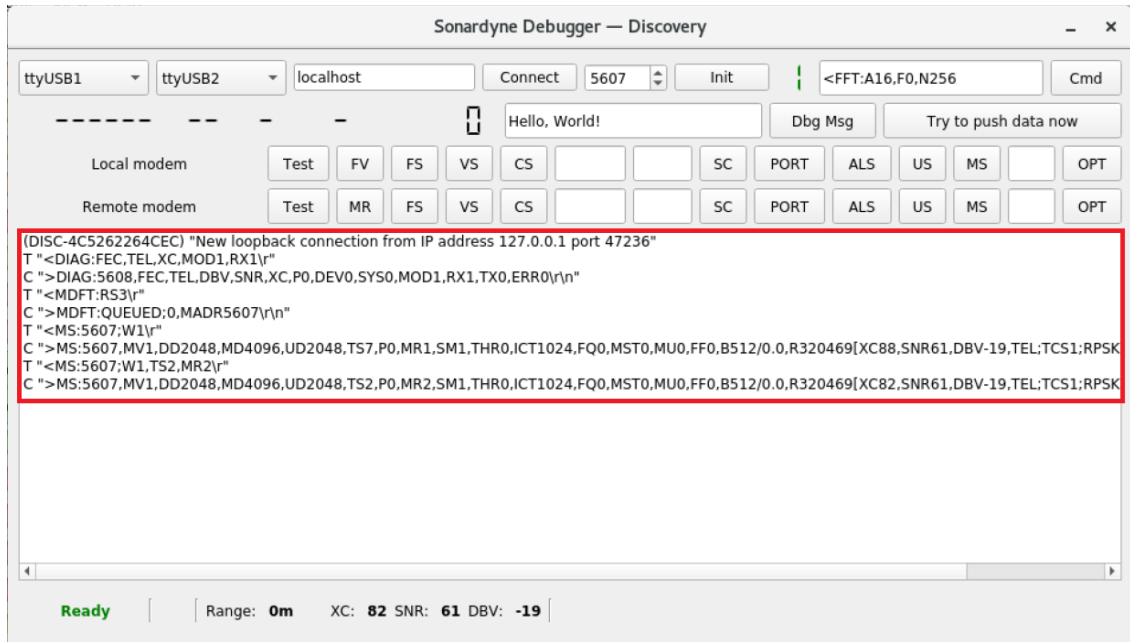

More details on console output are available in Section 15.3 on page **Error! Bookmark not defined.**

## 15.3 Troubleshooting

In the case of a suspected poor acoustic link, a methodical approach is required to ascertain the cause and any potential remedies. This section assumes that the *Bottom* modem is attached to a deployed OBS and the *Surface* modem is attached to a suitable deck/topside unit and suspended in water.

Before beginning to troubleshoot, first confirm that the *Surface* modem/transducer can be communicated with. To verify the connection to the *Surface* modem:

1. Ensure the acoustic modem driver IP address is correct ("localhost" if the *Surface* modem is physically connected) and click "Connect". This connects to the driver which will directly interact with the acoustic modem. If the status bar indicates **Network Error** then ensure the correct acoustic modem driver address before proceeding.
2. Ensure the serial port configuration for the two acoustic modem connections is correct (see Section 15.2 on page **Error! Bookmark not defined.**).
3. Ensure the *Remote* acoustic modem address of the OBS modem is shown correctly in the remote modem address field. If it is not, correct it.
4. Click the "Init" button. This will initialise, or reinitialise, the *Local Surface* modem. At this point the status bar should display **Ready**. If it does not, verify all relevant physical connections, network connections, serial ports and addresses.

In order to confirm the operation of the *Surface* modem, set its power parameters to suitable for air and initiate acoustic transmissions. It should be possible to hear the

transducer. If no audible signal can be detected from the *Surface* modem transducer, verify all relevant physical connections, power, network connections, serial ports and addresses.

If the *Surface* modem appears to operate correctly, lower it into the water to circa 10 meters and attempt to communicate with the OBS *Bottom* modem.

---

### 15.3.1 Send a short Command

When a suspected acoustic transmission problem occurs, start by attempting to send a short and simple *Command*. These are significantly more likely to succeed than *Data* transmissions.

The *MR* command (Measure Range) is recommended as the shortest and most likely acoustic transmission to successfully complete a round trip. This removes dependence on correctly set *Modem Status* Parameters (including *TS*, *DD*, *MD*, *ICT* and *UD*) and simplifies configuration efforts to *Configuration Status* Parameters (such as *SPL*, *TPL*, *LG* and *RXW*). *MR* is not the sole *Command* that serves this purpose.

A *MR* command can be sent from the *Sonardyne Debugger* found in Discovery (see Section 15.2 on page **Error! Bookmark not defined.**). It can be sent by typing the following command string into the custom command field:

```
<MR:aaaa;W1
```

[where *aaaa* is the *remote modem acoustic address* of the node you are attempting to communicate with]

Alternatively, for convenience, the *Remote* modem “MR” button is provided in the *Sonardyne Debugger* interface to send an *MR* command to the *Remote Modem Address* set and initialised in the *Local* acoustic modem driver.

If successful, the *MR* command will return with the round-trip time (in microseconds) as a parameter:

```
>MR:aaaa;R123456
```

If you do not receive a response containing a valid, non-zero, round-trip time, then the *MR* command has failed (even if no explicit error is given).

It is possible that the recipient modem may be in a low power sleep mode. If this is the case, the very first (and only the first) *Command* sent may fail. The addition of *w1* in a command instructs the modem to wake up.



**Note:** Early versions of Discovery do not correctly parse acoustic diagnostic/status information from received *MR* commands. In this case the *VS* command should be used for debugging. The *VS* command can be sent using the *Modem Ping* button in the *Post-Deploy* tab of *OBS Command & Control* widget.

## Command Failure

If this lightweight *Command* has failed to yield a successful reply, the *TPL*, *SPL*, *NPL*, *LG*, and *RXW* parameter values should be verified as correct for the deployment depth.

If the acoustic link state of health bar at the bottom of the *Command & Control* window (or elsewhere) is displaying recent values for *SNR* and *DBV*, these can indicate whether the depth related parameters require alteration. It also implies that the *Bottom* modem is receiving a transmission and responding. If *DBV* is high, this indicates the transmission power of the *Bottom* modem is too high or the *LG* of the *Surface* modem is too high, or both. These can be changed with the *Depth Configuration* section in the *Acoustic Configuration* tab of the *Command & Control* window. Experiment by changing parameters in the *Remote/Bottom* or *Surface/Local* modems individually and, if necessary, change the parameters in both.



**Note:** Assuming that before the deployment the bottom modem was correctly configured from the LPC web page, we recommend to try to fix the communication issues, trying first to change the parameters in the surface modem. This will avoid to risk to increase the power consumption in the OBS or to compromise permanently the acoustic link (thing that could happen if by mistake a too shallow setting is chosen, bringing *LG* parameter too low).

If the acoustic link state of health bar indicates low signal *DBV* or does not indicate any recent state of health information, then it is likely that the depth related parameters are set too shallow. Experiment by increasing the depth configuration in the *Remote/Bottom* or *Surface/Local* modems individually and, if necessary, change the parameters in both.

In the case where *DBV* acoustic diagnostic values appear to be healthy yet *SNR* values appear low, it is possible that noise from the ship is interfering. Try to lower the *Surface* modem lower to reduce noise or move to a less noisy area of the ship (i.e. far from the engine), or if other acoustic devices are on, ask to switch them off.

If, after increasing/decreasing depth parameters in both modems, it is still not possible to successfully send and receive an *MR* (or other lightweight) *Command*, it is likely that the distance between the two modems is too great. If the depth of the OBS is not believed to be the problem, then the lateral distance away from the position of the OBS is likely to be the cause. All acoustic modem transducers have an operating cone ( $\pm 40^\circ$  for the directional transducers,  $\pm 120^\circ$  for the omnidirectional transducers), outside of which their effectiveness is diminished. Attempt to move closer to the OBS and retry.



**Note:** The maximum permissible lateral distance between acoustic modems depends on depth; the deeper the water the further the lateral distance may be, the shallower the water the closer they must be. Always try to position a vessel as close to the estimated position of the OBS as possible.

### 15.3.2 Read Modem Status

If a lightweight *Command* is successfully transmitted and received, then the next step is to obtain more detailed information from the *Bottom* acoustic modem. This will further test the viability of the acoustic link whilst still limiting the range of relevant configuration parameters.

From the *Sonardyne Debugger* window, send a request for the *Configuration Status* parameter values by either clicking the *Remote* modem "CS" button, or sending the following *Command*:

```
<CS:aaaa;W1
```

[where *aaaa* is the *remote modem address* of the node you are attempting to communicate with]

Correct responses will follow this format:

```
>CS:aaaa,TATnnn,BLKnnn,RXWnnnn,TXWnnn,NPLnnn,TPLnnn,LGnn,CISn,ATn,
    ECn,ME n,RSPn,PPRn,Rnnnnnnn
    [XCnn,SNRnn,DBV-n,TEL;TCSn;RPSKVn_nnn,FEC0;0;0]
```

Erroneous responses may contain "NO\_REPLY":

```
>CS:aaaa,NO_REPLY
```

This indicates that no acoustic signal was received from the other/*Bottom* acoustic node within the *Receiver Wait Time (RXW)*. It is not possible to infer whether the original transmission was received by the *Bottom* or whether the *Bottom* modem attempted to transmit. Therefore, the configuration of both acoustic modems must be investigated.

Erroneous responses may also contain "NO\_DATA":

```
>CS:aaaa,NO_DATA OR >CS:aaaa,TATnnn,NO_DATA,RXWnnnn,TXWnnn,etc...
```

In this case the *Bottom* acoustic modem has received the initial *CS* command and attempted to respond. However, the acoustic transmission from *Bottom* to *Surface* was not successful. The most likely cause is improper configuration of the *Bottom* acoustic modem.

The procedure for improving the strength of the acoustic link is the same as for the lightweight command example given above. Ensure that appropriate power, gain, *RXW* values are set in both modems.

---

### 15.3.3 Get OBS System Information

If the previous troubleshooting procedures have succeeded, it is known that the acoustic link is strong enough to allow the two modem nodes to communicate. The parameters relevant to both *Command* and *Data* transmissions have been validated. From here, the next step is ensuring that the acoustic link is viable for transmitting

longer *Data* frames. There is a subset of acoustic modem parameters that affect *Data* transmissions specifically.

From the *Post Deploy* tab of the *OBS Command & Control* window, click either the “Get Aquarius ID” or “Get SEED ID” buttons. These will send an *MDFT* frame with a request for data (the Host Name or the SEED network and station codes respectively). The requested information should be returned by the OBS system in an *MDFT* frame.



**Note:** The LPC of an Aquarius system may be asleep. Sending a *Data* transmission instructs the system to wake up, but the first *Data* transmission sent to a sleeping Aquarius system will not return any data.

Following a successful “Get ID” operation, an identification string should be shown in the *Post Deploy* tab. If an ID is obtained, it is advisable to carry the operation a further 5 – 10 times to ensure that the acoustic link is performing adequately with minimal failed transmissions.

---

### System Information Request Failure

If it not possible to retrieve a system identifier (or there is an unacceptable failure rate), then begin verifying relevant parameters. There are a number of acoustic modem parameters that directly impact on the success of *Data* transmissions.

If the preceding *Command* based troubleshooting procedures have been followed, *MDFT* “NO\_REPLY” and “NO\_DATA” responses should not occur. If they do, the preceding troubleshooting sections should be repeated to verify correct power, gain and Receiver Wait parameter values.

#### **Successful *MDFT* response without data:**

The *MDFT* transmission may complete successfully (as far as the modems are concerned) without transmitting the anticipated data payload. In the modem debugging window (*Sonardyne Debugger*) this would look like:

```
<MDFT:aaaa;W1
>[MOD:TX;15;MST1]
>[MOD:RX;15, FROM;5110
  [XC86, SNR15, DBV-11, TEL;TCS1;RPSKV2_100, FEC0;0;0;0;0]
  ,MY_ACKS;8000]
>[MOD:STATUS;16, ID;11]
>[MOD:THEIR_ACKS;8000]
>[MOD:DONE]
>MDFT:5110, LDA0, RDA0, DC0
```

Here the transmission completes without any acoustic link errors, but identifying information may not be shown in the *Post Deploy* tab.

In this case, it is likely that the *Remote Bottom* modem attached to the OBS is not waiting long enough for the OBS system to process and collate the data payload before the modem send its response.

In this case it is necessary to increase one or more Local Modem Delays (*DD*, *UD*, *MD* or *ICT*) to force the *Bottom* modem to give enough time to the OBS to process a request for data.

The correct Local Modem Delay parameter values depend on the data processing operation that the OBS must carry out. They should be set correctly from factory and should not require alteration. If they require alteration, contact Güralp in the first instance.

If it is not possible to contact Güralp, then trial and error should be employed to identify which Local Modem Delay parameter value requires alteration. Increase each delay parameter in turn by single steps as required to regain communication with the OBS.

### ***MDFT* response missing subframe:**

The *MDFT* command may be received by the OBS *Bottom* modem and subsequently by the *Surface* modem, however the data payload may be lost. This would look like the following in the modem debugging window:

```
<MDFT:aaaa;W1
>[MOD:TX;15;MST1]
>[MOD:RX;NO_DATA[XC98,SNR15,DBV-11,TEL;TCS1;RPSKV2_100,
  FEC0;0;-1;0;0]]
>[MOD:RX;NO_REPLY[XC0,SNR0,DBV0,TEL;NONE]]
>[MOD:STATUS;16,ID;11]
>[MOD:THEIR_ACKS;8000]
>[MOD:DONE]
```

Here the modems can communicate *Commands* but struggle to transmit payload data.

Assuming that correct parameters values for power, gain and receiver wait have been set in the previous troubleshooting procedures; it is most likely that the data bitrate is set too high for the deployment scenario. The *Telemetry Scheme (TS)* parameter should be reduced in single steps until the *MDFT Data* transmission is reliably successful.

If *TS* is set to the lowest setting but data transmission is still failing, revisit earlier troubleshooting steps to validate other modem parameters.

---

## 15.3.4 Get Seismic Data

The most arduous test of the acoustic link is the transfer of seismic data from OBS to the surface. Seismic data is retrieved as individual 4KiB miniSEED records.



## Aquarius Ocean Bottom System

Using one of the methods outlined in this manual, identify and attempt to retrieve a miniSEED record. If successful, the following can be observed in the modem debugging window:

```
<MDFT:aaaa;W1
>[MOD:TX;15;MST1]
>[MOD:RX;15,FROM;5110[XC98,SNR18,DBV-8,TEL;TCS1;HDR_SE_3500,
  FEC0;0;0;0;0;0;0;0;0;0;0;0;0;0;0;0],MY_ACKS;8000]
>[MOD:RX;14,FROM;5110[XC97,SNR18,DBV-8,TEL;TCS1;HDR_SE_3500,
  FEC0;0;0;0;0;0;0;0;0;0;0;0;0;0;0;0],MY_ACKS;C000]
>[MOD:RX;13,FROM;5110[XC98,SNR18,DBV-8,TEL;TCS1;HDR_SE_3500,
  FEC0;0;0;0;0;0;0;0;0;0;0;0;0;0;0;0],MY_ACKS;E000]
>[MOD:STATUS;16,ID;10]
>[MOD:THEIR_ACKS;8000]
>[MOD:DONE]
```

The number of frames and sub-frames required to transmit 4 KiB depends on the value of the *Telemetry Scheme* parameter; the higher the *TS* value, the fewer sub-frames required.

At the end of the *Data* transmission, the data viewer window should open to display the seismic data.

---

## Seismic Data Transmission Failure

If the data viewer window fails to open, it is likely that one or more sub-frames were lost leading to an incomplete miniSEED record. This can be confirmed in the modem debugger window with the presence of:

```
>[MOD:RX;NO_DATA[XC98,SNR15,DBV-11,TEL;TCS1;RPSKV2_100,
  FEC0;0;-1;0;0]]
```

And/or:

```
>[MOD:RX;NO_REPLY[XC0,SNR0,DBV0,TEL;NONE]]
```

*FEC* is the number of telemetry code symbol errors corrected by the forward error correction algorithm. *-1* indicates that the correction power has been exceeded, so the error could not be corrected. The number of reported *FEC* values and the number of correctable errors is dependent on the telemetry type.

*FEC* values <4 are indicating a reasonable acoustic link, while *FEC* values between 4 and 6 are indicating a difficult acoustic link.

The number of permitted dropped sub-frames depends on the value of the *Modem Retries* or *MR* parameter. The higher the value for *MR*, the more sub-frames may be dropped with a successful data transfer.

In any case, the procedure for reducing the number of missing sub-frames is the same as the case of short *Data* transmissions. Revisit the previous section, or prior

## Aquarius Ocean Bottom System

sections if necessary, to verify correct parameter values. Starting by lowering *TS* in the bottom modem.

# 16 Appendix F – config.ini file

The config.ini file contains configuration parameters used by Discovery when launched.

In Linux config.ini is located at

*./config/Güralp Systems/Discovery*

In Windows the file is located at

*C:\Users\user\_name\AppData\Local\Guralp Systems\Discovery*

In order to edit the configuration file Discovery application has to be fully closed and no instance of it should be running in the system. The reason of this restriction is that Discovery application is overwriting the configuration file when closed so any file modifications done while the application is running will be lost.

The configuration file is divided in to multiple sections containing key-value type of entries. Every entry has a name/key and value assigned using '=' symbol.

## 16.1 Sections list

| Name               | Description                                    |
|--------------------|--|
| Settings           | General settings group of entries.             |
| Calibration        | Calibration related group of entries.          |
| Instruments        | Instrument settings group.                     |
| DataStream         | Settings used in data streaming configuration. |
| Viewer             | Data viewer group.                             |
| AnaloguePowerBoard | Power board configuration group of entries.    |

### 16.1.1 Section “Settings”

| Section:<br>[Settings]   | Entry:<br>Experimental | Value type:<br>Boolean | Accepted values:<br>true/false |
|--|------------------------|------------------------|--------------------------------|
| <p><i>Description:</i><br/>This entry enables or disables experimental mode for Discovery application. Experimental mode is not advised to be used since it enables functionalities that were not fully tested.</p> <p><i>Example:</i><br/>Experimental=true</p> |                        |                        |                                |

## Aquarius Ocean Bottom System

|                                       |
|---------------------------------------|
| <i>Default:</i><br>Experimental=false |
|---------------------------------------|

| <i>Section:</i><br><b>[Settings]</b>  | <i>Entry:</i><br><b>CloudRegistryGroupIdentifier</b> | <i>Value type:</i><br><b>String</b> | <i>Accepted values:</i><br><b>text</b> |
|---|--|-------------------------------------|--|
| <p><i>Description:</i><br/>This entry is used as cloud registry group identifier for devices lookup in Discovery "registry" mode. This entry is modified by Discovery during runtime through File/Settings.</p> <p><i>Example:</i><br/>CloudRegistryGroupIdentifier=public</p> <p><i>Default:</i><br/>CloudRegistryGroupIdentifier=</p> |  |                                     |  |

| <i>Section:</i><br><b>[Settings]</b>  | <i>Entry:</i><br><b>CloudRegistryIP</b> | <i>Value type:</i><br><b>String</b> | <i>Accepted values:</i><br><b>IP address as text</b> |
|---|---|-------------------------------------|--|
| <p><i>Description:</i><br/>This entry provides IP address of a cloud registry server. This value will be modified if registry server hostname entry translates to different IP address.</p> <p><i>Example:</i><br/>CloudRegistryIP=10.20.30.123</p> <p><i>Default:</i><br/>CloudRegistryIP=52.34.40.123</p> |   |                                     |  |

| <i>Section:</i><br><b>[Settings]</b>  | <i>Entry:</i><br><b>CloudRegistryHostname</b> | <i>Value type:</i><br><b>String</b> | <i>Accepted values:</i><br><b>hostname as text</b> |
|---|---|-------------------------------------|--|
| <p><i>Description:</i><br/>This entry provides hostname of a cloud registry server. This value will be used for translation in to an IP address.</p> <p><i>Example:</i><br/>CloudRegistryHostname=myhost.domain.com</p> <p><i>Default:</i><br/>CloudRegistryHostname=ec2-52-34-40-123.us-west-2.compute.amazonaws.com</p> |   |                                     |  |

| <i>Section:</i><br><b>[Settings]</b>   | <i>Entry:</i><br><b>CloudSelfGroupIdentifier</b> | <i>Value type:</i><br><b>String</b> | <i>Accepted values:</i><br><b>text</b> |
|--|--|-------------------------------------|--|
| <p><i>Description:</i><br/>This entry is used when Discovery is configured in self cloud server registering mode as a group identifier to where the computer belongs to.</p> <p><i>Example:</i><br/>CloudSelfGroupIdentifier=public</p> <p><i>Default:</i><br/>CloudSelfGroupIdentifier=</p> |  |                                     |  |

| <i>Section:</i><br><b>[Settings]</b>   | <i>Entry:</i><br><b>CloudSelfRegistering</b> | <i>Value type:</i><br><b>Boolean</b> | <i>Accepted values:</i><br><b>true/false</b> |
|--|--|--------------------------------------|--|
| <p><i>Description:</i><br/>This entry enables or disables self cloud server registering mode.</p> <p><i>Example:</i><br/>CloudSelfRegistering=true</p> |  |                                      |  |

## Aquarius Ocean Bottom System

|   |
|---|
| <i>Default:</i><br>CloudSelfRegistering=false |
|---|

| <i>Section:</i><br><b>[Settings]</b>  | <i>Entry:</i><br><b>BroadcastDiscoveryPing</b> | <i>Value type:</i><br><b>Boolean</b> | <i>Accepted values:</i><br><b>true/false</b> |
|---|--|--------------------------------------|--|
| <p><i>Description:</i><br/>This entry enables or disables sending broadcast discovery packet to other computers in the network. With this mode enabled, Discovery instance will notify all other computers in the network about its existence and current state of health.</p> <p><i>Example:</i><br/>BroadcastDiscoveryPing=true</p> <p><i>Default:</i><br/>BroadcastDiscoveryPing=false</p> |  |                                      |  |

| <i>Section:</i><br><b>[Settings]</b>  | <i>Entry:</i><br><b>ReplyToDiscoveryPing</b> | <i>Value type:</i><br><b>Boolean</b> | <i>Accepted values:</i><br><b>true/false</b> |
|---|--|--------------------------------------|--|
| <p><i>Description:</i><br/>This entry specifies if Discovery should respond to responder PING.</p> <p><i>Example:</i><br/>ReplyToDiscoveryPing=true</p> <p><i>Default:</i><br/>ReplyToDiscoveryPing=false</p> |  |                                      |  |

| <i>Section:</i><br><b>[Settings]</b>   | <i>Entry:</i><br><b>DefaultHTTPPort</b> | <i>Value type:</i><br><b>Integer</b> | <i>Accepted values:</i><br><b>Numbers</b> |
|--|---|--------------------------------------|---|
| <p><i>Description:</i><br/>This entry specifies the default HTTP port used for accessing the webpages.</p> <p><i>Example:</i><br/>DefaultHTTPPort=81</p> <p><i>Default:</i><br/>DefaultHTTPPort=80</p> |   |                                      |   |

| <i>Section:</i><br><b>[Settings]</b>  | <i>Entry:</i><br><b>MainWindowColumns</b> | <i>Value type:</i><br><b>List of integers</b> | <i>Accepted values:</i><br><b>Comma separated list of numbers</b> |
|---|---|---|---|
| <p><i>Description:</i><br/>This entry should not be edited manually – contains list of displayed columns in Discovery application main window.</p> <p><i>Example:</i><br/>MainWindowColumns=0, 3, 1, 8, 12, 13, 18, 17, 16, 10, 9, 11, 19, 15, 14, 2, 4, 5, 6, 7, 20</p> <p><i>Default:</i><br/>MainWindowColumns=0, 1, 2, 3, 4, 7, 8, 10, 12, 13</p> |   |   |   |

| <i>Section:</i><br><b>[Settings]</b>  | <i>Entry:</i><br><b>MainWindowSort</b> | <i>Value type:</i><br><b>Integer</b> | <i>Accepted values:</i><br><b>Numbers</b> |
|---|--|--------------------------------------|---|
| <p><i>Description:</i><br/>This entry should not be edited manually – contains index of a column to sort against.</p> |  |                                      |   |

## Aquarius Ocean Bottom System

|  |
|--|
| <p><i>Example:</i><br/>MainWindowSort=3</p> <p><i>Default:</i><br/>MainWindowSort=</p> |
|--|

| <i>Section:</i><br><b>[Settings]</b>  | <i>Entry:</i><br><b>StorageDir</b> | <i>Value type:</i><br><b>String</b> | <i>Accepted values:</i><br><b>Directory path as text</b> |
|---|------------------------------------|-------------------------------------|--|
| <p><i>Description:</i><br/>This entry specifies the path to Discovery storage root folder.</p> <p><i>Example:</i><br/>StorageDir=C:/data</p> <p><i>Default:</i><br/>StorageDir=C:/Users/user/AppData/Local/Temp/Guralp Storage/</p> |                                    |                                     |  |

| <i>Section:</i><br><b>[Settings]</b>   | <i>Entry:</i><br><b>SonardyneCmdPort</b> | <i>Value type:</i><br><b>String</b> | <i>Accepted values:</i><br><b>Serial port as text</b> |
|--|--|-------------------------------------|---|
| <p><i>Description:</i><br/>Defines serial port name used for communicating with the command port of the acoustic modem.</p> <p><i>Example:</i><br/>SonardyneCmdPort=ttyUSB0</p> <p><i>Default:</i><br/>SonardyneCmdPort=COM1</p> |  |                                     |   |

| <i>Section:</i><br><b>[Settings]</b>  | <i>Entry:</i><br><b>SonardyneDataPort</b> | <i>Value type:</i><br><b>String</b> | <i>Accepted values:</i><br><b>Serial port as text</b> |
|---|---|-------------------------------------|---|
| <p><i>Description:</i><br/>Defines serial port name used for communication with the data port of the acoustic modem.</p> <p><i>Example:</i><br/>SonardyneDataPort=ttyUSB1</p> <p><i>Default:</i><br/>SonardyneDataPort=COM2</p> |   |                                     |   |

| <i>Section:</i><br><b>[Settings]</b>  | <i>Entry:</i><br><b>SonardyneServerAddr</b> | <i>Value type:</i><br><b>String</b> | <i>Accepted values:</i><br><b>Hostname as text</b> |
|---|---|-------------------------------------|--|
| <p><i>Description:</i><br/>This value defines the location of the whalesong slave host. This entry can be configured as hostname or IP address.</p> <p><i>Example:</i><br/>SonardyneServerAddr=hostname.domain.com</p> <p><i>Default:</i><br/>SonardyneServerAddr=localhost</p> |   |                                     |  |

| <i>Section:</i><br><b>[Settings]</b>  | <i>Entry:</i><br><b>SonardyneModemAddr</b> | <i>Value type:</i><br><b>Integer</b> | <i>Accepted values:</i><br><b>Numbers</b> |
|---|--|--------------------------------------|---|
| <p><i>Description:</i><br/>This value defines the remote/ocean bottom acoustic modem address.</p> |  |                                      |   |

## Aquarius Ocean Bottom System

|   |
|---|
| <p><i>Example:</i><br/>SonardyneModemAddr=9999</p> <p><i>Default:</i><br/>SonardyneModemAddr=5607</p> |
|---|

| <i>Section:</i><br><b>[Settings]</b>   | <i>Entry:</i><br><b>TimeMachineIpAddresses</b> | <i>Value type:</i><br><b>String</b> | <i>Accepted values:</i><br><b>IP address as text</b> |
|--|--|-------------------------------------|--|
| <p><i>Description:</i><br/>Defines IP address of PTP server used for time source and GNSS location.</p> <p><i>Example:</i><br/>TimeMachineIpAddress=10.20.30.123</p> <p><i>Default:</i><br/>TimeMachineIpAddress=N/A</p> |  |                                     |  |

| <i>Section:</i><br><b>[Settings]</b>  | <i>Entry:</i><br><b>WhalesongStoragePath</b> | <i>Value type:</i><br><b>String</b> | <i>Accepted values:</i><br><b>Location as text</b> |
|---|--|-------------------------------------|--|
| <p><i>Description:</i><br/>This value specifies the storage location for data received through Whalesong protocol.</p> <p><i>Example:</i><br/>WhalesongStoragePath=</p> <p><i>Default:</i><br/>WhalesongStoragePath=C:/Users/user/AppData/Local/Temp/Whale/</p> |  |                                     |  |

| <i>Section:</i><br><b>[Settings]</b>   | <i>Entry:</i><br><b>NetworkActivityLogfile</b> | <i>Value type:</i><br><b>String</b> | <i>Accepted values:</i><br><b>File path as text</b> |
|--|--|-------------------------------------|---|
| <p><i>Description:</i><br/>This value specifies the path to a file that will be used for network traffic log.</p> <p><i>Example:</i><br/>NetworkActivityMonitor=true</p> <p><i>Default:</i><br/>NetworkActivityMonitor=false</p> |  |                                     |   |

| <i>Section:</i><br><b>[Settings]</b>  | <i>Entry:</i><br><b>NetworkActivityMonitor</b> | <i>Value type:</i><br><b>Boolean</b> | <i>Accepted values:</i><br><b>true/false</b> |
|---|--|--------------------------------------|--|
| <p><i>Description:</i><br/>This value determinates if network activity monitor is enabled or disabled.</p> <p><i>Example:</i><br/>NetworkActivityMonitor=true</p> <p><i>Default:</i><br/>NetworkActivityMonitor=false</p> |  |                                      |  |

| <i>Section:</i><br><b>[Settings]</b>  | <i>Entry:</i><br><b>LogEnabled</b> | <i>Value type:</i><br><b>Boolean</b> | <i>Accepted values:</i><br><b>true/false</b> |
|---|------------------------------------|--------------------------------------|--|
| <p><i>Description:</i><br/>Defines if Discovery application logging is enabled or not.</p> <p><i>Example:</i><br/>LogEnabled=true</p> <p><i>Default:</i><br/>LogEnabled=false</p> |                                    |                                      |  |

| <i>Section:</i><br><b>[Settings]</b>  | <i>Entry:</i><br><b>LogFile</b> | <i>Value type:</i><br><b>String</b> | <i>Accepted values:</i><br><b>File path as text</b> |
|---|---------------------------------|-------------------------------------|---|
| <p><i>Description:</i><br/>Defines file path and file name of Discovery application log file.</p> <p><i>Example:</i><br/>LogFile=C:/discovery.log</p> <p><i>Default:</i><br/>LogFile=C:/Users/user/AppData/Local/Temp/Discovery.log</p> |                                 |                                     |   |

| <i>Section:</i><br><b>[Settings]</b>  | <i>Entry:</i><br><b>LogFileSize</b> | <i>Value type:</i><br><b>Integer</b> | <i>Accepted values:</i><br><b>Numbers</b> |
|---|-------------------------------------|--------------------------------------|---|
| <p><i>Description:</i><br/>Defines maximum size in bytes of Discovery application log file.</p> <p><i>Example:</i><br/>LogFileSize=12345678</p> <p><i>Default:</i><br/>LogFileSize=2147483648</p> |                                     |                                      |   |

| <i>Section:</i><br><b>[Settings]</b>  | <i>Entry:</i><br><b>ResponderPreferredNetworkInterfaceName</b> | <i>Value type:</i><br><b>String</b> | <i>Accepted values:</i><br><b>text</b> |
|---|--|-------------------------------------|--|
| <p><i>Description:</i><br/>Specifies preferred network interface to be used for responder broadcast ping.</p> <p><i>Example:</i><br/>ResponderPreferredNetworkInterfaceName=ethernet_0</p> <p><i>Default:</i><br/>&lt;&lt;not specified&gt;&gt;</p> |  |                                     |  |

| <i>Section:</i><br><b>[Settings]</b>  | <i>Entry:</i><br><b>DoNotCreateCrashDump</b> | <i>Value type:</i><br><b>Boolean</b> | <i>Accepted values:</i><br><b>true/false</b> |
|---|--|--------------------------------------|--|
| <p><i>Description:</i><br/>Switches off or on the crash dump generation when Discovery application crashes.</p> <p><i>Example:</i><br/>DoNotCreateCrashDump=true</p> <p><i>Default:</i><br/>DoNotCreateCrashDump=</p> |  |                                      |  |

| <i>Section:</i><br><b>[Settings]</b>  | <i>Entry:</i><br><b>ShowUnknownSystemsInMainWindow</b> | <i>Value type:</i><br><b>Boolean</b> | <i>Accepted values:</i><br><b>true/false</b> |
|---|--|--------------------------------------|--|
| <p><i>Description:</i><br/>This entry specifies if unknown (or nameless) systems should be displayed in Discovery Main Window.</p> <p><i>Example:</i><br/>ShowUnknownSystemsInMainWindow=true</p> <p><i>Default:</i><br/>ShowUnknownSystemsInMainWindow=false</p> |  |                                      |  |



Aquarius Ocean Bottom System

| <i>Section:</i><br><b>[Settings]</b>   | <i>Entry:</i><br><b>AcceptBroadcastDevicesWithIPStartingWith</b> | <i>Value type:</i><br><b>String</b> | <i>Accepted values:</i><br><b>Text pattern</b> |
|--|--|-------------------------------------|--|
| <p><i>Description:</i><br/>If specified Discovery main table will contain systems with the start of IP address matching the entered value.</p> <p><i>Example:</i><br/>AcceptBroadcastDevicesWithIPStartingWith=192.168.0.</p> <p><i>Default:</i><br/>AcceptBroadcastDevicesWithIPStartingWith=</p> |  |                                     |  |

| <i>Section:</i><br><b>[Settings]</b>  | <i>Entry:</i><br><b>FileBasedWatchdogFile</b> | <i>Value type:</i><br><b>String</b> | <i>Accepted values:</i><br><b>File path as text</b> |
|---|---|-------------------------------------|---|
| <p><i>Description:</i><br/>Specifies the file path for a watchdog file.</p> <p><i>Example:</i><br/>FileBasedWatchdogFile=C:/Users/user/AppData/Local/Temp/DiscoWatchdog</p> <p><i>Default:</i><br/>FileBasedWatchdogFile=</p> |   |                                     |   |

| <i>Section:</i><br><b>[Settings]</b>  | <i>Entry:</i><br><b>FileBasedWatchdogTimeout</b> | <i>Value type:</i><br><b>String</b> | <i>Accepted values:</i><br><b>File path as text</b> |
|---|--|-------------------------------------|---|
| <p><i>Description:</i><br/>Specifies the timeout (in seconds) used to update the file-based watchdog file.</p> <p><i>Example:</i><br/>FileBasedWatchdogTimeout=300</p> <p><i>Default:</i><br/>FileBasedWatchdogTimeout=</p> |  |                                     |   |

| <i>Section:</i><br><b>[Settings]</b>  | <i>Entry:</i><br><b>LoggingPowerBoardFileName</b> | <i>Value type:</i><br><b>String</b> | <i>Accepted values:</i><br><b>File path as text</b> |
|---|---|-------------------------------------|---|
| <p><i>Description:</i><br/>Specifies a path to file that will be used for logging power board information.</p> <p><i>Example:</i><br/>LoggingPowerBoardFileName=C:/Users/user/AppData/Local/Temp/PowerBoard.log</p> <p><i>Default:</i><br/>LoggingPowerBoardFileName=</p> |   |                                     |   |

| <i>Section:</i><br><b>[Settings]</b>   | <i>Entry:</i><br><b>LoggingPowerBoardFileSize</b> | <i>Value type:</i><br><b>Integer</b> | <i>Accepted values:</i><br><b>Number</b> |
|--|---|--------------------------------------|--|
| <p><i>Description:</i><br/>Specifies a maximum size that the power board logging file can use (in bytes).</p> <p><i>Example:</i><br/>LoggingPowerBoardFileSize=1000000</p> <p><i>Default:</i><br/>LoggingPowerBoardFileSize=</p> |   |                                      |  |

|   |  |                                      |   |
|---|--|--------------------------------------|---|
| <i>Section:</i><br><b>[Settings]</b>  | <i>Entry:</i><br><b>LoggingPowerBoardInterval</b>  | <i>Value type:</i><br><b>Integer</b> | <i>Accepted values:</i><br><b>Number</b>            |
| <p><i>Description:</i><br/>Specifies the length of interval between power board information logging (in milliseconds)</p> <p><i>Example:</i><br/>LoggingPowerBoardInterval=30000</p> <p><i>Default:</i><br/>LoggingPowerBoardInterval=</p>  |  |                                      |   |
| <i>Section:</i><br><b>[Settings]</b>  | <i>Entry:</i><br><b>LoggingTimeMachineFileName</b> | <i>Value type:</i><br><b>String</b>  | <i>Accepted values:</i><br><b>File path as text</b> |
| <p><i>Description:</i><br/>Specifies a path to file that will be used for logging time machine (PTP server) information.</p> <p><i>Example:</i><br/>LoggingTimeMachineFileName=C:/Users/user/AppData/Local/Temp/PowerBoard.log</p> <p><i>Default:</i><br/>LoggingTimeMachineFileName=</p> |  |                                      |   |
| <i>Section:</i><br><b>[Settings]</b>  | <i>Entry:</i><br><b>LoggingTimeMachineFileSize</b> | <i>Value type:</i><br><b>Integer</b> | <i>Accepted values:</i><br><b>Number</b>            |
| <p><i>Description:</i><br/>Specifies a maximum size that the time machine (PTP server) logging file can use (in bytes).</p> <p><i>Example:</i><br/>LoggingTimeMachineFileSize=1000000</p> <p><i>Default:</i><br/>LoggingTimeMachineFileSize=</p>  |  |                                      |   |
| <i>Section:</i><br><b>[Settings]</b>  | <i>Entry:</i><br><b>LoggingTimeMachineInterval</b> | <i>Value type:</i><br><b>Integer</b> | <i>Accepted values:</i><br><b>Number</b>            |
| <p><i>Description:</i><br/>Specifies the length of interval between time machine (PTP server) information logging (in milliseconds)</p> <p><i>Example:</i><br/>LoggingTimeMachineInterval=30000</p> <p><i>Default:</i><br/>LoggingTimeMachineInterval=</p>                                |  |                                      |   |

---

## 16.1.2 Section “Calibration”

Aquarius Ocean Bottom System

| <i>Section:</i><br><b>[Calibration]</b>   | <i>Entry:</i><br><b>RadianTiltTableConnected</b> | <i>Value type:</i><br><b>Boolean</b> | <i>Accepted values:</i><br><b>true/false</b> |
|---|--|--------------------------------------|--|
| <p><i>Description:</i><br/>Defines if radian tilt table is connected to the computer that Discovery is running on.</p> <p><i>Example:</i><br/>RadianTiltTableConnected=true</p> <p><i>Default:</i><br/>RadianTiltTableConnected=false</p> |  |                                      |  |

| <i>Section:</i><br><b>[Calibration]</b>  | <i>Entry:</i><br><b>BijouTiltTableConnected</b> | <i>Value type:</i><br><b>Boolean</b> | <i>Accepted values:</i><br><b>true/false</b> |
|--|---|--------------------------------------|--|
| <p><i>Description:</i><br/>Defines if bijou tilt table is connected to the computer that Discovery is running on.</p> <p><i>Example:</i><br/>BijouTiltTableConnected=true</p> <p><i>Default:</i><br/>BijouTiltTableConnected=false</p> |   |                                      |  |

| <i>Section:</i><br><b>[Calibration]</b>  | <i>Entry:</i><br><b>AccelerometerCalibrationEnabled</b> | <i>Value type:</i><br><b>Boolean</b> | <i>Accepted values:</i><br><b>true/false</b> |
|--|---|--------------------------------------|--|
| <p><i>Description:</i><br/>Defines if radian accelerometer calibration functionality is enabled in the application.</p> <p><i>Example:</i><br/>AccelerometerCalibrationEnabled=true</p> <p><i>Default:</i><br/>AccelerometerCalibrationEnabled=false</p> |   |                                      |  |

| <i>Section:</i><br><b>[Calibration]</b>   | <i>Entry:</i><br><b>MagnetometerCalibrationEnabled</b> | <i>Value type:</i><br><b>Boolean</b> | <i>Accepted values:</i><br><b>true/false</b> |
|---|--|--------------------------------------|--|
| <p><i>Description:</i><br/>Defines if radian magnetometer calibration functionality is enabled in the application.</p> <p><i>Example:</i><br/>MagnetometerCalibrationEnabled=true</p> <p><i>Default:</i><br/>MagnetometerCalibrationEnabled=false</p> |  |                                      |  |

| <i>Section:</i><br><b>[Calibration]</b>  | <i>Entry:</i><br><b>CalibrationShakeTable</b> | <i>Value type:</i><br><b>Boolean</b> | <i>Accepted values:</i><br><b>true/false</b> |
|--|---|--------------------------------------|--|
| <p><i>Description:</i><br/>Defines if sensor calibration shake table functionality is enabled in the application.</p> <p><i>Example:</i></p> |   |                                      |  |

## Aquarius Ocean Bottom System

|   |
|---|
| <p>CalibrationShakeTable=true<br/> <i>Default:</i><br/> CalibrationShakeTable=false</p> |
|---|

| <i>Section:</i><br><b>[Calibration]</b>   | <i>Entry:</i><br><b>CalibrationRadianBalancing</b> | <i>Value type:</i><br><b>Boolean</b> | <i>Accepted values:</i><br><b>true/false</b> |
|---|--|--------------------------------------|--|
| <p><i>Description:</i><br/> Defines if sensor calibration balancing functionality is enabled in the application.<br/> <i>Example:</i><br/> CalibrationRadianBalancing=true<br/> <i>Default:</i><br/> CalibrationRadianBalancing=false</p> |  |                                      |  |

| <i>Section:</i><br><b>[Calibration]</b>  | <i>Entry:</i><br><b>DbEntry</b> | <i>Value type:</i><br><b>Boolean</b> | <i>Accepted values:</i><br><b>true/false</b> |
|--|---------------------------------|--------------------------------------|--|
| <p><i>Description:</i><br/> Defines if calibration values database connectivity is enabled.<br/> <i>Example:</i><br/> DbEntry=true<br/> <i>Default:</i><br/> DbEntry=false</p> |                                 |                                      |  |

| <i>Section:</i><br><b>[Calibration]</b>  | <i>Entry:</i><br><b>CalibrationPageEditorEnabled</b> | <i>Value type:</i><br><b>Boolean</b> | <i>Accepted values:</i><br><b>true/false</b> |
|--|--|--------------------------------------|--|
| <p><i>Description:</i><br/> Defines if calibration editor widget is enabled in the application.<br/> <i>Example:</i><br/> CalibrationPageEditorEnabled=true<br/> <i>Default:</i><br/> CalibrationPageEditorEnabled=false</p> |  |                                      |  |

| <i>Section:</i><br><b>[Calibration]</b>  | <i>Entry:</i><br><b>MinimusADCCalibrationEnabled</b> | <i>Value type:</i><br><b>Boolean</b> | <i>Accepted values:</i><br><b>true/false</b> |
|--|--|--------------------------------------|--|
| <p><i>Description:</i><br/> Defines if Minimus ADC calibration functionality is enabled in the application.<br/> <i>Example:</i><br/> MinimusADCCalibrationEnabled=true<br/> <i>Default:</i><br/> MinimusADCCalibrationEnabled=false</p> |  |                                      |  |

| <i>Section:</i><br><b>[Calibration]</b> | <i>Entry:</i><br><b>MinimusADCCalibrationDBEnabled</b> | <i>Value type:</i><br><b>Boolean</b> | <i>Accepted values:</i><br><b>true/false</b> |
|---|--|--------------------------------------|--|
| <p><i>Description:</i></p>              |  |                                      |  |

## Aquarius Ocean Bottom System

|  |
|--|
| <p>Defines if Minimus ADC calibration database interface is enabled in the application.</p> <p><i>Example:</i><br/>MinimusADCCalibrationDBEnabled=true</p> <p><i>Default:</i><br/>MinimusADCCalibrationDBEnabled=false</p> |
|--|

| <i>Section:</i><br><b>[Calibration]</b>   | <i>Entry:</i><br><b>SpringExerciseEnabled</b> | <i>Value type:</i><br><b>Boolean</b> | <i>Accepted values:</i><br><b>true/false</b> |
|---|---|--------------------------------------|--|
| <p><i>Description:</i><br/>Defines if spring exercise functionality is enabled in the application.</p> <p><i>Example:</i><br/>SpringExerciseEnabled=true</p> <p><i>Default:</i><br/>SpringExerciseEnabled=false</p> |   |                                      |  |

| <i>Section:</i><br><b>[Calibration]</b>  | <i>Entry:</i><br><b>CalibrationMeterHostname</b> | <i>Value type:</i><br><b>String</b> | <i>Accepted values:</i><br><b>Hostname or IP address as text</b> |
|--|--|-------------------------------------|--|
| <p><i>Description:</i><br/>Specifies hostname or IP address of ADC calibration meter used in Minimus/Minimus+ calibration widget.</p> <p><i>Example:</i><br/>CalibrationMeterHostname=meter.hostname.domain.com</p> <p><i>Default:</i><br/>CalibrationMeterHostname=meter1</p> |  |                                     |  |

| <i>Section:</i><br><b>[Calibration]</b>   | <i>Entry:</i><br><b>CalibrationSignalGeneratorHostname</b> | <i>Value type:</i><br><b>String</b> | <i>Accepted values:</i><br><b>Hostname or IP address as text</b> |
|---|--|-------------------------------------|--|
| <p><i>Description:</i><br/>Specifies hostname or IP address of ADC calibration meter used in Minimus/Minimus+ calibration widget.</p> <p><i>Example:</i><br/>CalibrationSignalGeneratorHostname=siggen.hostname.domain.com</p> <p><i>Default:</i><br/>CalibrationSignalGeneratorHostname=sig1</p> |  |                                     |  |

| <i>Section:</i><br><b>[Calibration]</b>   | <i>Entry:</i><br><b>FortisNoiseToleranceThreshold</b> | <i>Value type:</i><br><b>Float</b> | <i>Accepted values:</i><br><b>Numbers</b> |
|---|---|------------------------------------|---|
| <p><i>Description:</i></p> <p><i>Example:</i><br/>FortisNoiseToleranceThreshold=0</p> <p><i>Default:</i><br/>FortisNoiseToleranceThreshold=0.019999999552965164</p> |   |                                    |   |

Aquarius Ocean Bottom System

| <i>Section:</i><br><b>[Calibration]</b>  | <i>Entry:</i><br><b>FortisCalArmCurrent</b> | <i>Value type:</i><br><b>Integer</b> | <i>Accepted values:</i><br><b>Numbers</b> |
|--|---|--------------------------------------|---|
| <i>Description:</i>                      |   |                                      |   |
| <i>Example:</i><br>FortisCalArmCurrent=2 |   |                                      |   |
| <i>Default:</i><br>FortisCalArmCurrent=3 |   |                                      |   |

| <i>Section:</i><br><b>[Calibration]</b> | <i>Entry:</i><br><b>FortisCalArmSerial</b> | <i>Value type:</i><br><b>Integer</b> | <i>Accepted values:</i><br><b>Numbers</b> |
|---|--|--------------------------------------|---|
| <i>Description:</i>                     |  |                                      |   |
| <i>Example:</i><br>FortisCalArmSerial=1 |  |                                      |   |
| <i>Default:</i><br>FortisCalArmSerial=0 |  |                                      |   |

| <i>Section:</i><br><b>[Calibration]</b>     | <i>Entry:</i><br><b>FortisCalSpinnerSerial</b> | <i>Value type:</i><br><b>Integer</b> | <i>Accepted values:</i><br><b>Numbers</b> |
|---|--|--------------------------------------|---|
| <i>Description:</i>                         |  |                                      |   |
| <i>Example:</i><br>FortisCalSpinnerSerial=1 |  |                                      |   |
| <i>Default:</i><br>FortisCalSpinnerSerial=0 |  |                                      |   |

| <i>Section:</i><br><b>[Calibration]</b>      | <i>Entry:</i><br><b>FortisCalSpinnerCurrent</b> | <i>Value type:</i><br><b>Integer</b> | <i>Accepted values:</i><br><b>Numbers</b> |
|--|---|--------------------------------------|---|
| <i>Description:</i>                          |   |                                      |   |
| <i>Example:</i><br>FortisCalSpinnerCurrent=1 |   |                                      |   |
| <i>Default:</i><br>FortisCalSpinnerCurrent=2 |   |                                      |   |

| <i>Section:</i><br><b>[Calibration]</b>             | <i>Entry:</i><br><b>FortisCaldocSaveFolder</b> | <i>Value type:</i><br><b>String</b> | <i>Accepted values:</i><br><b>Directory path as text</b> |
|---|--|-------------------------------------|--|
| <i>Description:</i>                                 |  |                                     |  |
| <i>Example:</i><br>FortisCaldocSaveFolder=C:/caldoc |  |                                     |  |
| <i>Default:</i><br>FortisCaldocSaveFolder=          |  |                                     |  |

| <i>Section:</i><br><b>[Calibration]</b>                                   | <i>Entry:</i><br><b>IMSDatabase</b> | <i>Value type:</i><br><b>Boolean</b> | <i>Accepted values:</i><br><b>true/false</b> |
|---|-------------------------------------|--------------------------------------|--|
| <i>Description:</i><br>Defines if IMS database connectivity is available. |                                     |                                      |  |

## Aquarius Ocean Bottom System

|   |
|---|
| <i>Example:</i><br>IMSDatabase=true<br><i>Default:</i><br>IMSDatabase=false |
|---|

| <i>Section:</i><br><b>[Calibration]</b>  | <i>Entry:</i><br><b>EnableDigitalSensorCalibration</b> | <i>Value type:</i><br><b>Boolean</b> | <i>Accepted values:</i><br><b>true/false</b> |
|--|--|--------------------------------------|--|
| <i>Description:</i><br>Defines if digital sensors calibration values in Calibration Editor can be edited by the user. If this value is set to false, calibration editor (if enabled) will display digital sensor calibration values as read-only.<br><i>Example:</i><br>EnableDigitalSensorCalibration=true<br><i>Default:</i><br>EnableDigitalSensorCalibration=false |  |                                      |  |

| <i>Section:</i><br><b>[Calibration]</b>  | <i>Entry:</i><br><b>FortimusCurveFitting</b> | <i>Value type:</i><br><b>Boolean</b> | <i>Accepted values:</i><br><b>true/false</b> |
|--|--|--------------------------------------|--|
| <i>Description:</i><br>Defines if Fortimus curve fitting data processing functionality is available in the application.<br><i>Example:</i><br>FortimusCurveFitting=true<br><i>Default:</i><br>FortimusCurveFitting=false |  |                                      |  |

---

### 16.1.3 Section “Instruments”

| <i>Section:</i><br><b>[Instruments]</b>  | <i>Entry:</i><br><b>InstrumentsDebug</b> | <i>Value type:</i><br><b>Boolean</b> | <i>Accepted values:</i><br><b>true/false</b> |
|--|--|--------------------------------------|--|
| <i>Description:</i><br>Specifies if instruments debug widget is available in Discovery device control centre.<br><i>Example:</i><br>InstrumentsDebug=true<br><i>Default:</i><br>InstrumentsDebug=false |  |                                      |  |

---

### 16.1.4 Section “DataStream”

| <i>Section:</i><br><b>[DataStream]</b>   | <i>Entry:</i><br><b>GDI\ListenerEnabled</b> | <i>Value type:</i><br><b>Boolean</b> | <i>Accepted values:</i><br><b>true/false</b> |
|--|---|--------------------------------------|--|
| <i>Description:</i><br>Specifies if GDI listener is enabled in the application.<br><i>Example:</i> |   |                                      |  |

Aquarius Ocean Bottom System

|  |
|--|
| GDI\ListenerEnabled=true<br><i>Default:</i><br>GDI\ListenerEnabled=false |
|--|

| <i>Section:</i><br><b>[DataStream]</b>   | <i>Entry:</i><br><b>GDI\ListenerPort</b> | <i>Value type:</i><br><b>Integer</b> | <i>Accepted values:</i><br><b>Numbers</b> |
|--|--|--------------------------------------|---|
| <i>Description:</i><br>Specifies the listening port for GDI TCP/IP listener.<br><i>Example:</i><br>GDI\ListenerPort=1234<br><i>Default:</i><br>GDI\ListenerPort=4567 |  |                                      |   |

| <i>Section:</i><br><b>[DataStream]</b>   | <i>Entry:</i><br><b>GDI\MaximumRAMAllowance</b> | <i>Value type:</i><br><b>Integer</b> | <i>Accepted values:</i><br><b>Numbers</b> |
|--|---|--------------------------------------|---|
| <i>Description:</i><br>Defines the maximum RAM allowance for GDI data pool (in bytes).<br><i>Example:</i><br>GDI\MaximumRAMAllowance=2048<br><i>Default:</i><br><not included> |   |                                      |   |

| <i>Section:</i><br><b>[DataStream]</b>  | <i>Entry:</i><br><b>GDI\AutoInit</b> | <i>Value type:</i><br><b>List</b> | <i>Accepted values:</i><br><b>List of system names</b> |
|---|--------------------------------------|-----------------------------------|--|
| <i>Description:</i><br>Specifies a list of system that the connection will be automatically initiated when one appears in Discovery list.<br><i>Example:</i><br>GDI\AutoInit=<br><i>Default:</i><br>GDI\AutoInit= |                                      |                                   |  |



Section “viewer”

| <i>Section:</i><br><b>[viewer]</b>  | <i>Entry:</i><br><b>SelectionMenu</b> | <i>Value type:</i> | <i>Accepted values:</i> |
|---|---------------------------------------|--------------------|-------------------------|
| <p><i>Description:</i></p> <p><i>Example:</i><br/>SelectionMenu=@Invalid()<br/><i>Default:</i><br/>SelectionMenu=@Invalid()</p> |                                       |                    |                         |

16.1.5 Section “AnaloguePowerBoard”

| <i>Section:</i><br><b>[AnaloguePowerBoard]</b>   | <i>Entry:</i><br><b>Enabled</b> | <i>Value type:</i><br><b>Boolean</b> | <i>Accepted values:</i><br><b>true/false</b> |
|--|---------------------------------|--------------------------------------|--|
| <p><i>Description:</i><br/>Defines if the analogue power board control functionality is enabled in the application.<br/><i>Example:</i><br/>Enabled=true<br/><i>Default:</i><br/>Enabled=false</p> |                                 |                                      |  |

| <i>Section:</i><br><b>[AnaloguePowerBoard]</b>  | <i>Entry:</i><br><b>SerialConnection</b> | <i>Value type:</i><br><b>Boolean</b> | <i>Accepted values:</i><br><b>true/false</b> |
|---|--|--------------------------------------|--|
| <p><i>Description:</i><br/>Defines if the analogue power board is connected locally through serial port.<br/><i>Example:</i><br/>SerialConnection=true<br/><i>Default:</i><br/>SerialConnection=false</p> |  |                                      |  |

| <i>Section:</i><br><b>[AnaloguePowerBoard]</b>   | <i>Entry:</i><br><b>SerialPortName</b> | <i>Value type:</i><br><b>String</b> | <i>Accepted values:</i><br><b>Serial port name as text</b> |
|--|--|-------------------------------------|--|
| <p><i>Description:</i><br/>Defines the name of serial port that analogue power board is connected to.<br/><i>Example:</i><br/>SerialPortName=ttyUSB0<br/><i>Default:</i><br/>SerialPortName=</p> |  |                                     |  |

| <i>Section:</i><br><b>[AnaloguePowerBoard]</b> | <i>Entry:</i><br><b>SerialBaudRate</b> | <i>Value type:</i><br><b>Integer</b> | <i>Accepted values:</i><br><b>Numbers</b> |
|--|--|--------------------------------------|---|
|--|--|--------------------------------------|---|

## Aquarius Ocean Bottom System

|   |
|---|
| <p><i>Description:</i><br/>Defines the baud rate of serial port connection to the analogue power board.</p> <p><i>Example:</i><br/>SerialPortName=9600</p> <p><i>Default:</i><br/>SerialPortName=115200</p> |
|---|

| <i>Section:</i><br><b>[AnaloguePowerBoard]</b>  | <i>Entry:</i><br><b>LabelJ08</b> | <i>Value type:</i><br><b>String</b> | <i>Accepted values:</i><br><b>Text</b> |
|---|----------------------------------|-------------------------------------|--|
| <p><i>Description:</i><br/>Specifies text label used for graphical user interface to describe analogue power board connector J08. Note that if the label is not configured information and controls for this connector are not going to be displayed in graphical interface.</p> <p><i>Example:</i><br/>LabelJ08=MINHI</p> <p><i>Default:</i><br/>LabelJ08=</p> |                                  |                                     |  |

| <i>Section:</i><br><b>[AnaloguePowerBoard]</b>  | <i>Entry:</i><br><b>LabelJ09</b> | <i>Value type:</i><br><b>String</b> | <i>Accepted values:</i><br><b>Text</b> |
|---|----------------------------------|-------------------------------------|--|
| <p><i>Description:</i><br/>Specifies text label used for graphical user interface to describe analogue power board connector J09. Note that if the label is not configured information and controls for this connector are not going to be displayed in graphical interface.</p> <p><i>Example:</i><br/>LabelJ09=MINLO</p> <p><i>Default:</i><br/>LabelJ09=</p> |                                  |                                     |  |

| <i>Section:</i><br><b>[AnaloguePowerBoard]</b>  | <i>Entry:</i><br><b>LabelJ10</b> | <i>Value type:</i><br><b>String</b> | <i>Accepted values:</i><br><b>Text</b> |
|---|----------------------------------|-------------------------------------|--|
| <p><i>Description:</i><br/>Specifies text label used for graphical user interface to describe analogue power board connector J10. Note that if the label is not configured information and controls for this connector are not going to be displayed in graphical interface.</p> <p><i>Example:</i><br/>LabelJ10=RADHI</p> <p><i>Default:</i><br/>LabelJ10=</p> |                                  |                                     |  |

| <i>Section:</i><br><b>[AnaloguePowerBoard]</b>   | <i>Entry:</i><br><b>LabelJ11</b> | <i>Value type:</i><br><b>String</b> | <i>Accepted values:</i><br><b>Text</b> |
|--|----------------------------------|-------------------------------------|--|
| <p><i>Description:</i><br/>Specifies text label used for graphical user interface to describe analogue power board connector J11. Note that if the label is not configured information</p> |                                  |                                     |  |

## Aquarius Ocean Bottom System

and controls for this connector are not going to be displayed in graphical interface.

*Example:*

LabelJ11=RADLO

*Default:*

LabelJ11=

| <i>Section:</i><br><b>[AnaloguePowerBoard]</b>  | <i>Entry:</i><br><b>LabelJ12</b> | <i>Value type:</i><br><b>String</b> | <i>Accepted values:</i><br><b>Text</b> |
|---|----------------------------------|-------------------------------------|--|
| <p><i>Description:</i><br/>Specifies text label used for graphical user interface to describe analogue power board connector J12. Note that if the label is not configured information and controls for this connector are not going to be displayed in graphical interface.</p> <p><i>Example:</i><br/>LabelJ12=HOLEH</p> <p><i>Default:</i><br/>LabelJ12=</p> |                                  |                                     |  |

| <i>Section:</i><br><b>[AnaloguePowerBoard]</b>  | <i>Entry:</i><br><b>LabelJ13</b> | <i>Value type:</i><br><b>String</b> | <i>Accepted values:</i><br><b>Text</b> |
|---|----------------------------------|-------------------------------------|--|
| <p><i>Description:</i><br/>Specifies text label used for graphical user interface to describe analogue power board connector J13. Note that if the label is not configured information and controls for this connector are not going to be displayed in graphical interface.</p> <p><i>Example:</i><br/>LabelJ13=HOLEL</p> <p><i>Default:</i><br/>LabelJ13=</p> |                                  |                                     |  |

| <i>Section:</i><br><b>[AnaloguePowerBoard]</b>   | <i>Entry:</i><br><b>ControlsJ08</b> | <i>Value type:</i><br><b>Boolean</b> | <i>Accepted values:</i><br><b>true/false</b> |
|--|-------------------------------------|--------------------------------------|--|
| <p><i>Description:</i><br/>Specifies whether controls for analogue power board connector J08 are available in the graphical user interface.</p> <p><i>Example:</i><br/>ControlsJ08=true</p> <p><i>Default:</i><br/>ControlsJ08=false</p> |                                     |                                      |  |

| <i>Section:</i><br><b>[AnaloguePowerBoard]</b>   | <i>Entry:</i><br><b>ControlsJ09</b> | <i>Value type:</i><br><b>Boolean</b> | <i>Accepted values:</i><br><b>true/false</b> |
|--|-------------------------------------|--------------------------------------|--|
| <p><i>Description:</i><br/>Specifies whether controls for analogue power board connector J09 are available in the graphical user interface.</p> <p><i>Example:</i><br/>ControlsJ09=true</p> <p><i>Default:</i><br/>ControlsJ09=false</p> |                                     |                                      |  |

## Aquarius Ocean Bottom System

| <i>Section:</i><br><b>[AnaloguePowerBoard]</b>   | <i>Entry:</i><br><b>ControlsJ10</b> | <i>Value type:</i><br><b>Boolean</b> | <i>Accepted values:</i><br><b>true/false</b> |
|--|-------------------------------------|--------------------------------------|--|
| <p><i>Description:</i><br/>Specifies whether controls for analogue power board connector J10 are available in the graphical user interface.</p> <p><i>Example:</i><br/>ControlsJ10=true</p> <p><i>Default:</i><br/>ControlsJ10=false</p> |                                     |                                      |  |

| <i>Section:</i><br><b>[AnaloguePowerBoard]</b>   | <i>Entry:</i><br><b>ControlsJ11</b> | <i>Value type:</i><br><b>Boolean</b> | <i>Accepted values:</i><br><b>true/false</b> |
|--|-------------------------------------|--------------------------------------|--|
| <p><i>Description:</i><br/>Specifies whether controls for analogue power board connector J11 are available in the graphical user interface.</p> <p><i>Example:</i><br/>ControlsJ11=true</p> <p><i>Default:</i><br/>ControlsJ11=false</p> |                                     |                                      |  |

| <i>Section:</i><br><b>[AnaloguePowerBoard]</b>   | <i>Entry:</i><br><b>ControlsJ12</b> | <i>Value type:</i><br><b>Boolean</b> | <i>Accepted values:</i><br><b>true/false</b> |
|--|-------------------------------------|--------------------------------------|--|
| <p><i>Description:</i><br/>Specifies whether controls for analogue power board connector J12 are available in the graphical user interface.</p> <p><i>Example:</i><br/>ControlsJ12=true</p> <p><i>Default:</i><br/>ControlsJ12=false</p> |                                     |                                      |  |

| <i>Section:</i><br><b>[AnaloguePowerBoard]</b>   | <i>Entry:</i><br><b>ControlsJ13</b> | <i>Value type:</i><br><b>Boolean</b> | <i>Accepted values:</i><br><b>true/false</b> |
|--|-------------------------------------|--------------------------------------|--|
| <p><i>Description:</i><br/>Specifies whether controls for analogue power board connector J13 are available in the graphical user interface.</p> <p><i>Example:</i><br/>ControlsJ13=true</p> <p><i>Default:</i><br/>ControlsJ13=false</p> |                                     |                                      |  |

| <i>Section:</i><br><b>[AnaloguePowerBoard]</b>  | <i>Entry:</i><br><b>FuseMonitoringJ0</b><br><b>8</b> | <i>Value type:</i><br><b>Boolean</b> | <i>Accepted values:</i><br><b>true/false</b> |
|---|--|--------------------------------------|--|
| <p><i>Description:</i><br/>Specifies whether fuse monitoring label should be displayed in the Power Board UI.</p> <p><i>Default:</i> true</p> |  |                                      |  |

| <i>Section:</i><br><b>[AnaloguePowerBoard]</b> | <i>Entry:</i> | <i>Value type:</i> | <i>Accepted values:</i><br><b>true/false</b> |
|--|---------------|--------------------|--|
|  |               |                    |  |

Aquarius Ocean Bottom System

|   |   |  |   |
|---|---|--|---|
|   | <b>FuseMonitoringJ0</b><br>9                  | <b>Boolean</b>                         |   |
| <p><i>Description:</i><br/>Specifies whether fuse monitoring label should be displayed in the Power Board UI.<br/><i>Default:</i> true</p>        |   |  |   |
| <i>Section:</i><br><b>[AnaloguePowerBoard]</b>  | <i>Entry:</i><br><b>FuseMonitoringJ1</b><br>0 | <i>Value type:</i><br><b>Boolean</b>   | <i>Accepted values:</i><br><b>true/false</b>      |
| <p><i>Description:</i><br/>Specifies whether fuse monitoring label should be displayed in the Power Board UI.<br/><i>Default:</i> true</p>        |   |  |   |
| <i>Section:</i><br><b>[AnaloguePowerBoard]</b>  | <i>Entry:</i><br><b>FuseMonitoringJ1</b><br>1 | <i>Value type:</i><br><b>Boolean</b>   | <i>Accepted values:</i><br><b>true/false</b>      |
| <p><i>Description:</i><br/>Specifies whether fuse monitoring label should be displayed in the Power Board UI.<br/><i>Default:</i> true</p>        |   |  |   |
| <i>Section:</i><br><b>[AnaloguePowerBoard]</b>  | <i>Entry:</i><br><b>FuseMonitoringJ1</b><br>2 | <i>Value type:</i><br><b>Boolean</b>   | <i>Accepted values:</i><br><b>true/false</b>      |
| <p><i>Description:</i><br/>Specifies whether fuse monitoring label should be displayed in the Power Board UI.<br/><i>Default:</i> true</p>        |   |  |   |
| <i>Section:</i><br><b>[AnaloguePowerBoard]</b>  | <i>Entry:</i><br><b>FuseMonitoringJ1</b><br>3 | <i>Value type:</i><br><b>Boolean</b>   | <i>Accepted values:</i><br><b>true/false</b>      |
| <p><i>Description:</i><br/>Specifies whether fuse monitoring label should be displayed in the Power Board UI.<br/><i>Default:</i> true</p>        |   |  |   |
| <i>Section:</i><br><b>[AnaloguePowerBoard]</b>  | <i>Entry:</i><br><b>NextSwitchOnJ10</b>       | <i>Value type:</i><br><b>QDateTime</b> | <i>Accepted values:</i><br><b>QDateTime value</b> |
| <p><i>Description:</i><br/>This entry should not be modified manually. Specifies timestamp of the next power-on configured for connector J10.</p> |   |  |   |
| <i>Section:</i><br><b>[AnaloguePowerBoard]</b>  | <i>Entry:</i><br><b>NextSwitchOnJ11</b>       | <i>Value type:</i><br><b>QDateTime</b> | <i>Accepted values:</i><br><b>QDateTime value</b> |

Aquarius Ocean Bottom System

|   |
|---|
| <p><i>Description:</i><br/>This entry should not be modified manually. Specifies timestamp of the next power-on configured for connector J11.</p> |
|---|

|  |   |  |   |
|--|---|--|---|
| <p><i>Section:</i><br/><b>[AnaloguePowerBoard]</b></p> | <p><i>Entry:</i><br/><b>NextSwitchOnJ12</b></p> | <p><i>Value type:</i><br/><b>QDateTime</b></p> | <p><i>Accepted values:</i><br/><b>QDateTime value</b></p> |
|--|---|--|---|

|   |
|---|
| <p><i>Description:</i><br/>This entry should not be modified manually. Specifies timestamp of the next power-on configured for connector J12.</p> |
|---|

|  |   |  |   |
|--|---|--|---|
| <p><i>Section:</i><br/><b>[AnaloguePowerBoard]</b></p> | <p><i>Entry:</i><br/><b>NextSwitchOnJ13</b></p> | <p><i>Value type:</i><br/><b>QDateTime</b></p> | <p><i>Accepted values:</i><br/><b>QDateTime value</b></p> |
|--|---|--|---|

|   |
|---|
| <p><i>Description:</i><br/>This entry should not be modified manually. Specifies timestamp of the next power-on configured for connector J13.</p> |
|---|

|  |  |  |   |
|--|--|--|---|
| <p><i>Section:</i><br/><b>[AnaloguePowerBoard]</b></p> | <p><i>Entry:</i><br/><b>NextSwitchOnTimeoutJ10</b></p> | <p><i>Value type:</i><br/><b>Integer</b></p> | <p><i>Accepted values:</i><br/><b>Numbers</b></p> |
|--|--|--|---|

|  |
|--|
| <p><i>Description:</i><br/>This entry should not be modified manually. Specifies timeout configured for next switch on of connector J10.</p> |
|--|

|  |  |  |   |
|--|--|--|---|
| <p><i>Section:</i><br/><b>[AnaloguePowerBoard]</b></p> | <p><i>Entry:</i><br/><b>NextSwitchOnTimeoutJ11</b></p> | <p><i>Value type:</i><br/><b>Integer</b></p> | <p><i>Accepted values:</i><br/><b>Numbers</b></p> |
|--|--|--|---|

|  |
|--|
| <p><i>Description:</i><br/>This entry should not be modified manually. Specifies timeout configured for next switch on of connector J11.</p> |
|--|

|  |  |  |   |
|--|--|--|---|
| <p><i>Section:</i><br/><b>[AnaloguePowerBoard]</b></p> | <p><i>Entry:</i><br/><b>NextSwitchOnTimeoutJ12</b></p> | <p><i>Value type:</i><br/><b>Integer</b></p> | <p><i>Accepted values:</i><br/><b>Numbers</b></p> |
|--|--|--|---|

|  |
|--|
| <p><i>Description:</i><br/>This entry should not be modified manually. Specifies timeout configured for next switch on of connector J12.</p> |
|--|

|  |  |  |   |
|--|--|--|---|
| <p><i>Section:</i><br/><b>[AnaloguePowerBoard]</b></p> | <p><i>Entry:</i><br/><b>NextSwitchOnTimeoutJ13</b></p> | <p><i>Value type:</i><br/><b>Integer</b></p> | <p><i>Accepted values:</i><br/><b>Numbers</b></p> |
|--|--|--|---|

|  |
|--|
| <p><i>Description:</i><br/>This entry should not be modified manually. Specifies timeout configured for next switch on of connector J13.</p> |
|--|

|  |   |  |   |
|--|---|--|---|
| <p><i>Section:</i><br/><b>[AnaloguePowerBoard]</b></p> | <p><i>Entry:</i><br/><b>AutoSwitchOffTimeoutWhenPSUOn</b></p> | <p><i>Value type:</i><br/><b>Integer</b></p> | <p><i>Accepted values:</i><br/><b>Numbers</b></p> |
|--|---|--|---|

Aquarius Ocean Bottom System

|  |  |                |  |
|--|--|----------------|--|
|  |  | <b>Integer</b> |  |
| <p><i>Description:</i><br/>                 Specifies timeout in seconds of when the system is going to be switched off if the reason of analogue power board power on is "power supply switch on". Please note that minimal timeout is 5 minutes (300 seconds) and any value lower than 300 will be overwritten in the application to 300 seconds.</p> <p><i>Example:</i><br/>                 AutoSwitchOffTimeoutWhenPSUOn=600</p> <p><i>Default:</i><br/>                 AutoSwitchOffTimeoutWhenPSUOn=</p> |  |                |  |

| <i>Section:</i><br><b>[AnaloguePowerBoard]</b>   | <i>Entry:</i><br><b>AutoSwitchOffTimeoutWhenAcousticComms</b> | <i>Value type:</i><br><b>Integer</b> | <i>Accepted values:</i><br><b>Numbers</b> |
|--|---|--------------------------------------|---|
| <p><i>Description:</i><br/>                 Specifies timeout in seconds of when the system is going to be switched off if the reason of analogue power board power on is "acoustic modem communication". Please note that minimal timeout is 5 minutes (300 seconds) and any value lower than 300 will be overwritten in the application to 300 seconds.</p> <p><i>Example:</i><br/>                 AutoSwitchOffTimeoutWhenAcousticComms=600</p> <p><i>Default:</i><br/>                 AutoSwitchOffTimeoutWhenAcousticComms=</p> |   |                                      |   |

| <i>Section:</i><br><b>[AnaloguePowerBoard]</b>   | <i>Entry:</i><br><b>AutoSwitchOffTimeoutWhenPowerBoardTimer</b> | <i>Value type:</i><br><b>Integer</b> | <i>Accepted values:</i><br><b>Numbers</b> |
|--|---|--------------------------------------|---|
| <p><i>Description:</i><br/>                 Specifies timeout in seconds of when the system is going to be switched off if the reason of analogue power board power on is "internal power board timer". Please note that minimal timeout is 5 minutes (300 seconds) and any value lower than 300 will be overwritten in the application to 300 seconds.</p> <p><i>Example:</i><br/>                 AutoSwitchOffTimeoutWhenPowerBoardTimer=600</p> <p><i>Default:</i><br/>                 AutoSwitchOffTimeoutWhenPowerBoardTimer=</p> |   |                                      |   |

| <i>Section:</i><br><b>[AnaloguePowerBoard]</b>   | <i>Entry:</i><br><b>AutoSwitchOffTimeoutWhenPulseFromShore</b> | <i>Value type:</i><br><b>Integer</b> | <i>Accepted values:</i><br><b>Numbers</b> |
|--|--|--------------------------------------|---|
| <p><i>Description:</i><br/>                 Specifies timeout in seconds of when the system is going to be switched off if the reason of analogue power board power on is "pulse from shore". Please note that minimal timeout is 5 minutes (300 seconds) and any value lower than 300 will be overwritten in the application to 300 seconds.</p> <p><i>Example:</i><br/>                 AutoSwitchOffTimeoutWhenPulseFromShore=600</p> |  |                                      |   |

Aquarius Ocean Bottom System

*Default:*  
AutoSwitchOffTimeoutWhenPulseFromShore=

| <i>Section:</i><br><b>[AnaloguePowerBoard]</b>   | <i>Entry:</i><br><b>SwitchOffSystemWhenPowerOffConnector</b> | <i>Value type:</i><br><b>Integer</b> | <i>Accepted values:</i><br><b>Numbers</b> |
|--|--|--------------------------------------|---|
| <p><i>Description:</i><br/>Determinates based on which connector power off request to switch off the operating system cleanly – issue system power down command.</p> <p><i>Example:</i><br/>SwitchOffSystemWhenPowerOffConnector=11</p> <p><i>Default:</i><br/>SwitchOffSystemWhenPowerOffConnector=</p> |  |                                      |   |

| <i>Section:</i><br><b>[AnaloguePowerBoard]</b>   | <i>Entry:</i><br><b>ServerConnectionPort</b> | <i>Value type:</i><br><b>Integer</b> | <i>Accepted values:</i><br><b>Numbers</b> |
|--|--|--------------------------------------|---|
| <p><i>Description:</i><br/>Specifies server connection port. This port is used to open the connection to the power board server from a client.</p> <p><i>Example:</i><br/>ServerConnectionPort=25002</p> <p><i>Default:</i><br/>ServerConnectionPort=17789</p> |  |                                      |   |

| <i>Section:</i><br><b>[AnaloguePowerBoard]</b>   | <i>Entry:</i><br><b>ServerListeningPort</b> | <i>Value type:</i><br><b>Integer</b> | <i>Accepted values:</i><br><b>Numbers</b> |
|--|---|--------------------------------------|---|
| <p><i>Description:</i><br/>Specifies server listening port. This port is used to listen for any incoming connections from remote power board client.</p> <p><i>Example:</i><br/>ServerListeningPort=25002</p> <p><i>Default:</i><br/>ServerListeningPort=17789</p> |   |                                      |   |

| <i>Section:</i><br><b>[AnaloguePowerBoard]</b>   | <i>Entry:</i><br><b>SwitchOnSequenceWhenPSUOn</b> | <i>Value type:</i><br><b>QList of integers</b> | <i>Accepted values:</i><br><b>Comma separated numbers</b> |
|--|---|--|---|
| <p><i>Description:</i><br/>Specifies a list of connector numbers to switch on when power board power on reason is "power supply on". Other connectors will get switched off.</p> <p><i>Example:</i><br/>SwitchOnSequenceWhenPSUOn=11, 13, 10</p> <p><i>Default:</i><br/>SwitchOnSequenceWhenPSUOn=11, 13</p> |   |  |   |

| <i>Section:</i> | <i>Entry:</i> | <i>Value type:</i> | <i>Accepted values:</i> |
|-----------------|---------------|--------------------|-------------------------|
|                 |               |                    |                         |



Aquarius Ocean Bottom System

| <b>[AnaloguePowerBoard]</b>  | <b>SwitchOnSequenceWhenAcousticComms</b> | <b>QList of integers</b> | <b>Comma separated numbers</b> |
|--|--|--------------------------|--------------------------------|
| <p><i>Description:</i><br/>Specifies a list of connector numbers to switch on when power board power on reason is "acoustic modem communication". Other connectors will get switched off.</p> <p><i>Example:</i><br/>SwitchOnSequenceWhenAcousticComms=11, 13, 10</p> <p><i>Default:</i><br/>SwitchOnSequenceWhenAcousticComms=<br/>@Variant(\0\0\0\t\0\0\0\x1\0\0\0\x2\0\0\0\v)</p> |  |                          |                                |

| <i>Section:</i><br><b>[AnaloguePowerBoard]</b>   | <i>Entry:</i><br><b>SwitchOnSequenceWhenPowerBoardTimer</b> | <i>Value type:</i><br><b>QList of integers</b> | <i>Accepted values:</i><br><b>Comma separated numbers</b> |
|--|---|--|---|
| <p><i>Description:</i><br/>Specifies a list of connector numbers to switch on when power board power on reason is "power board timer". Other connectors will get switched off.</p> <p><i>Example:</i><br/>SwitchOnSequenceWhenPowerBoardTimer=11, 13, 10</p> <p><i>Default:</i><br/>SwitchOnSequenceWhenPowerBoardTimer=11, 13</p> |   |  |   |

| <i>Section:</i><br><b>[AnaloguePowerBoard]</b>  | <i>Entry:</i><br><b>SwitchOnSequenceWhenPulseFromShore</b> | <i>Value type:</i><br><b>QList of integers</b> | <i>Accepted values:</i><br><b>Comma separated numbers</b> |
|---|--|--|---|
| <p><i>Description:</i><br/>Specifies a list of connector numbers to switch on when power board power on reason is "pulse from shore". Other connectors will get switched off.</p> <p><i>Example:</i><br/>SwitchOnSequenceWhenPulseFromShore=11, 13</p> <p><i>Default:</i><br/>SwitchOnSequenceWhenPulseFromShore=11, 13, 10</p> |  |  |   |

## 17 Appendix G – Glossary

**APG** : Absolute Pressure Gauge

**CS** : Configuration Status

**DBV** : Degree of Voice Breaks

**DD** : Data Delay

**DHCP** : Dynamic Host Configuration Protocol

**FEC** : Forward Error Correction

**GPS** : Global Positioning System

**HDPE** : Hyper-Density PolyEthylene

**ICT** : Inter Character Time

**IP** : Internet Protocol

**LAN** : Local Area Network

**LED** : Light-Emitting Diode

**LG** : Linear Gain

**LMF** : Lower Medium Frequency

**LPC** : Low Power Computer

**LTA** : Long Term Average

**MD** : Modem Delay

**MDFT** : Modem Data Frame Transfer

**MEMS** : MicroElectroMechanical System

**MPPT** : Maximum Power Point Tracking

**MR** : Master Retries

**MR (command)** : Measure Range

**MS** : Modem Status

**NPL** : Navigation Power Level

**OBS** : Ocean Bottom System

**PoE** : Power over Ethernet

**PTP** : Precision Time Protocol

## Aquarius Ocean Bottom System

**RAM** : Random-Access Memory

**ROV** : Remotely Operated underwater Vehicle

**RXW** : Receiver Wait

**SBC** : Single Board Computer

**SoH** : State of Health

**SPL** : Start Power Level

**SNR** : Signal to Noise Ratio.

**STA** : Short Term Average

**TAT** : Turn-Around-Time

**TPL** : Telemetry Power Level

**TS** : Telemetry Scheme

**UD** : Uplink Delay

**UID** : Unique IDentification

**ULPD** : Ultra Low Power Digitiser

**XC** : Cross Correlation

## 18 Revision history

|   |            |   |
|---|------------|---|
| A | 07/12/2020 | Initial Release                         |
| B | 10/08/2021 | System/ballast assembly procedure added |
| C | 20/08/2021 | References tidied up                    |